



Flash frequency



WARNING: This toy produces flashes that may trigger epilepsy in sensitised individuals.

Only for use by children aged 8 years and older. Not suitable for children and under 8 years due to small parts which could cause a choking hazard.

Light bulb warning



WARNING! Hot surface, do not touch bulb.



203
PROJECTS

35
PARTS



Overview: Amendments of the new EN 62115: 2020/A11:2020 concerning batteries and LEDs

Batteries

Small batteries

Batteries that fit wholly within the small parts cylinder (as specified in §8.2 of EN 71-1:2014+A1:2018) shall not be removable without the aid of a tool.

For parts of electric toys containing batteries, where the part fits wholly within the small parts cylinder (as specified in 8.2 of EN 71-1:2014+A1:2018), batteries shall not be accessible without the aid of a tool.

Other batteries

Batteries shall not be removable without the aid of a tool unless the security of the battery compartment cover is adequate.

Compliance is checked by inspection and by the following test. An attempt is made to gain access to the battery compartment by manual means. It shall not be possible to open the cover unless at least two independent movements have to be applied simultaneously.

The electric toy is placed on a horizontal steel surface.

A cylindrical metallic mass of 1 kg, having a diameter of 80 mm, is dropped from a height of 100 mm so that its flat face falls onto the electric toy. The test is carried out once with the cylindrical metallic mass striking the electric toy in the most unfavourable place. The battery compartment shall not become open.

- ▶ So all batteries need a battery cover in future, which complies with the specifications above.

Batteries supplied with the toy

Primary batteries supplied with electric toys shall comply with the relevant parts of the IEC 60086 series.

- ▶ A Pass Test Report is needed.

Secondary batteries supplied with electric toys shall comply with IEC 62133.

- ▶ A Pass Test Report is needed.

Battery compartment fasteners

If screws or similar fasteners are used to secure a door or cover providing access to the battery compartment, the screw or similar fastener shall be captive to ensure that they remain with the door, cover or equipment.

Compliance is checked by inspection and by the following test after the battery door or cover is opened. A force of 20N is applied to the screw or similar fastener without jerks for a duration of 10s in any direction.

The screw or similar fastener shall not become separated from the door, cover or equipment.

Light-emitting diodes

The emission from electric toys incorporating LEDs shall not exceed the following limits:

- 0,01 Wm⁻² when assessed at 10 mm from the LED front for accessible emissions with wavelengths of < 315 nm;
- 0,01 Wsr⁻¹ or 0,25 Wm⁻² when assessed at 200 mm, for accessible emissions with wavelengths of 315 nm ≤ λ < 400 nm;

- 0,04 Wsr⁻¹ or the AEL specified in Tables E.2 or E.3 assessed at 200 mm for accessible emissions with wavelengths of 400 nm ≤ λ < 780 nm;
- 0,64 Wsr⁻¹ or 16 Wm⁻² when assessed at 200 mm for accessible emissions with wavelengths of 780 nm ≤ λ < 1 000 nm;
- 0,32 Wsr⁻¹ or 8 Wm⁻² when assessed at 200 mm for accessible emissions with wavelengths of 1 000 nm ≤ λ < 3 000 nm.

LED data sheets

As the technical data sheet is essential for compliance with this standard, it shall be developed following the measurement criteria of condition A or condition B of CIE 127. The technical data sheet shall indicate that it has been created using the CIE 127 measurement methods and as a minimum include:

- the luminous intensity in candela or radiant intensity in Watts per steradian as a function of forward current,
- the angle,
- the peak wavelength,
- the spectral emission bandwidth,
- the date of issue and the revision number.

- ▶ So all LEDs need a LED data sheet in future, which includes the specifications above.

Table of Contents

Basic Troubleshooting	1	DOs and DON'Ts of Building Circuits	9
Parts List	2	Advanced Troubleshooting	10
How to Use Boffin	3	Project Listings	11, 12
About Your Boffin Parts	4-6	Projects 1 - 203	13-76
Summary of Games in the LED MC (U29)	7	Notes	77
Introduction to Electricity	8	Other Boffin Projects	78



WARNING: SHOCK HAZARD - Never connect Boffin to the electrical outlets in your home in any way!



WARNING: CHOKING HAZARD - Small parts. Not for children under 3 years.



WARNING: Moving parts. Do not touch the fan while it is spinning.

Conforms to all applicable U.S. government requirements and CAN ICES-3 (B)/NMB-3 (B).

Basic Troubleshooting

1. Most circuit problems are due to incorrect assembly, always double-check that your circuit exactly matches the drawing for it.
2. Be sure that parts with positive/negative markings are positioned as per the drawing.
3. Be sure that all connections are securely snapped.
4. Try replacing the batteries.
5. If the programmable fan (M8) does not display any messages, then it could be because you erased them without programming in new ones. See project 15 for instructions on how to program it.

ConQuest entertainment is not responsible for parts damaged due to incorrect wiring.

Note: If you suspect you have damaged parts, you can follow the Advanced Troubleshooting procedure on page 10 to determine which ones need replacing.

WARNING: Always check your wiring before turning on a circuit. Never leave a circuit unattended while the batteries are installed. Never connect additional batteries or any other power sources to your circuits. Discard any cracked or broken parts.

Adult Supervision:

Because children's abilities vary so much, even with age groups, adults should exercise discretion as to which experiments are suitable and safe (the instructions should enable supervising adults to

establish the experiment's suitability for the child). Make sure your child reads and follows all of the relevant instructions and safety procedures, and keeps them at hand for reference.

This product is intended for use by adults and children who have attained sufficient maturity to read and follow directions and warnings.

Never modify your parts, as doing so may disable important safety features in them, and could put your child at risk of injury.





























Batteries:

- Use only 1.5V AA type, alkaline batteries (not included).
- Insert batteries with correct polarity.
- Non-rechargeable batteries should not be recharged. Rechargeable batteries should only be charged under adult supervision, and should not be recharged while in the product.
- Do not connect batteries or battery holders in parallel.
- Do not mix old and new batteries.
- Do not mix alkaline, standard (carbon-zinc), or rechargeable (nickel-cadmium) batteries.
- Remove batteries when they are used up.
- Do not short circuit the battery terminals.
- Never throw batteries in a fire or attempt to open its outer casing.
- Batteries are harmful if swallowed, so keep away from small children.

Parts List (Colors and styles may vary) Symbols and Numbers

Important: If any parts are missing or damaged, **DO NOT RETURN TO RETAILER.** Call toll-free: 284 000 111 or e-mail us at: info@cqe.cz. Customer Service • ConQuest entertainment a.s., Kolbenova 961, 198 00 Praha 9, www.boffin.cz, www.toy.cz.

Qty.	ID	Name	Symbol	Part #	Qty.	ID	Name	Symbol	Part #
☐ 1		Base Grid (11.0" x 7.7")		6SCBG	☐ 1		Jumper Wire (Black, 18")		6SCJ1
☐ 2	①	1-Snap Wire		6SC01	☐ 1		Jumper Wire (Red, 18")		6SCJ2
☐ 6	②	2-Snap Wire		6SC02	☐ 1		Jumper Wire (Orange, 8")		6SCJ3A
☐ 3	③	3-Snap Wire		6SC03	☐ 2		Jumper Wire (Blue, 4")		6SCJ4
☐ 1	④	4-Snap Wire		6SC04	☐ 1	Ⓜ8	Programmable Fan		6SCM8
☐ 1	⑤	5-Snap Wire		6SC05	☐ 1	Ⓚ1	PNP Transistor		6SCQ1
☐ 1	Ⓚ3	Battery Holder - uses three (3) 1.5V type "AA" (not Included)		6SCB3	☐ 1	Ⓚ2	NPN Transistor		6SCQ2
☐ 1	Ⓚ1	Red Light Emitting Diode (LED)		6SCD1	☐ 1	Ⓚ1	Slide Switch		6SCS1
☐ 1	Ⓚ2	Green Light Emitting Diode (LED)		6SCD2	☐ 1	Ⓚ2	Press Switch		6SCS2
☐ 1	Ⓚ10	Red/Yellow Bicolor Light Emitting Diode (LED)		6SCD10	☐ 1	Ⓚ8	Selector		6SCS8
☐ 1	ⓀM	Disco Motor		6SCDM	☐ 1	ⓀP2	Speaker		6SCSP2
☐ 1		Support Bar for Disco Covers		6SCDMSB	☐ 1	Ⓚ2	Alarm IC		6SCU2
☐ 1		Disco Cover, Triangle		6SCDMCT	☐ 1	Ⓚ29	LED Display and Microcontroller		6SCU29
☐ 1		Disco Cover, Hexagon		6SCDMCH					

How to Use Boffin

Boffin uses building blocks with snaps to build the different electrical and electronic circuits in the projects. Each block has a function: there are switch blocks, light blocks, battery blocks, different length wire blocks, etc. These blocks are different colors and have numbers on them so that you can easily identify them. The blocks you will be using are shown as color symbols with level numbers next to them, allowing you to easily snap them together to form a circuit.

For Example:

This is the slide switch, it is green and has the marking **S1** on it. The part symbols in this booklet may not exactly match the appearance of the actual parts, but will clearly identify them.



This is a wire block which is blue and comes in different wire lengths.

This one has the number **2**, **3**, **4**, or **5** on it depending on the length of the wire connection required.

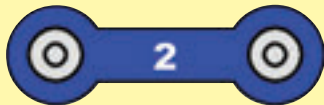

There is also a 1-snap wire that is used as a spacer or for interconnection between different layers.



You need a power source to build each circuit. This is labeled **B3** and requires three (3) 1.5V "AA" batteries (not included).



A large clear plastic base grid is included with this kit to help keep the circuit blocks properly spaced. You will see evenly spaced posts that the different blocks snap into. The base has rows labeled A-G and columns labeled 1-10.

Next to each part in every circuit drawing is a small number in black. This tells you which level the component is placed at. Place all parts on level 1 first, then all of the parts on level 2, then all of the parts on level 3, etc.

Some circuits use the jumper wires to make unusual connections. Just clip them to the metal snaps or as indicated.



The programmable fan (M8) displays messages. You can change the messages displayed using project 15.

Most projects that use the LED MC (U29) require that you select a game using the selector (S8). This is explained in the projects, but here are a few notes:

- There are 21 games available.
- If you try to select a game number higher than 21 then the display will be reset to "00".
- When the player wins, loses or finishes a game, the display will say "Go" again and the player can play the game again.
- The only way to select a different game is by turning off the circuit and then turning it back on so that "00" appears on the display again.

Some projects have you mount one of the disco covers on the disco motor (DM):

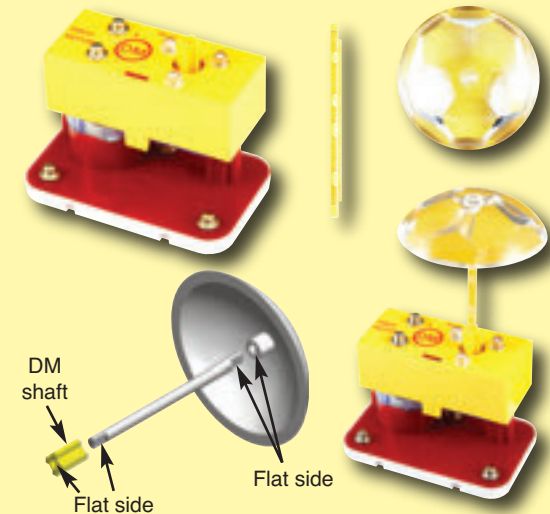

Note: While building the projects, be careful not to accidentally make a direct connection across the battery holder (a "short circuit"), as this may damage and/or quickly drain the batteries.

About Your Boffin Parts

(Part designs are subject to change without notice).

BASE GRID

The **base grid** is a platform for mounting parts and wires. It functions like the printed circuit boards used in most electronic products, or like how the walls are used for mounting the electrical wiring in your home.

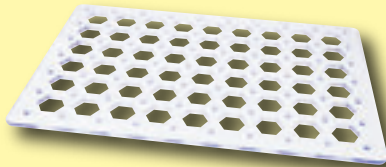

SNAP WIRES & JUMPER WIRES

The blue **snap wires** are wires used to connect components. They are used to transport electricity and do not affect circuit performance. They come in different lengths to allow orderly arrangement of connections on the base grid.

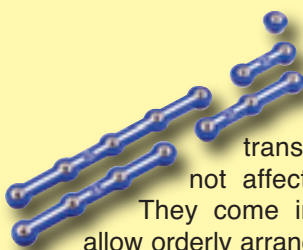

The **jumper wires** (red, black, orange, & blue) make flexible connections for times when using the snap wires would be difficult. They also are used to make connections off the base grid.



Wires transport electricity just like pipes are used to transport water. The colorful plastic coating protects them and prevents electricity from getting in or out.

BATTERY HOLDER

The **batteries (B3)** produce an electrical voltage using a chemical reaction. This “voltage” can be thought of as electrical pressure, pushing electricity through a circuit just like a pump pushes water through pipes. This voltage is much lower and much safer than that used in your house wiring. Using more batteries increases the “pressure”, therefore, more electricity flows.



Battery Holder (B3)

SLIDE & PRESS SWITCHES

The **slide & press switches (S1 & S2)** connect (pressed or “ON”) or disconnect (not pressed or “OFF”) the wires in a circuit. When ON they have no effect on circuit performance. Switches turn on electricity just like a faucet turns on water from a pipe.

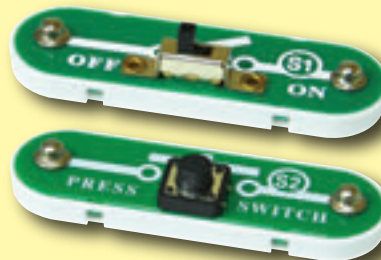

Slide & Press Switches (S1 & S2)

The **selector (S8)** is a more complex switch that will often be used with the LED MC (U29).

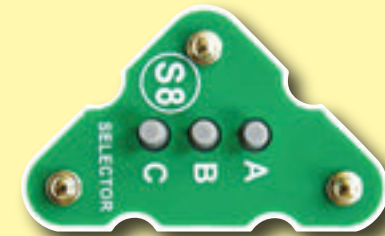

Selector (S8)

For people familiar with schematic diagrams, the schematic for the selector looks like this:

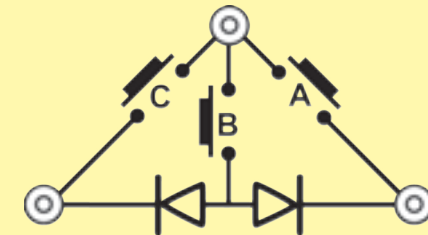

SPEAKER

The **speaker (SP2)** converts electricity into sound by making mechanical vibrations. These vibrations create variations in air pressure, which travel across the room. You “hear” sound when your ears feel these air pressure variations.



Speaker (SP2)

About Your Boffin Parts

TRANSISTORS

The **PNP & NPN transistors (Q1 & Q2)** are components that use a small electric current to control a large current, and are used in switching, amplifier, and buffering applications. They are easy to miniaturize, and are the main building blocks of integrated circuits including the microprocessor and memory circuits in computers.

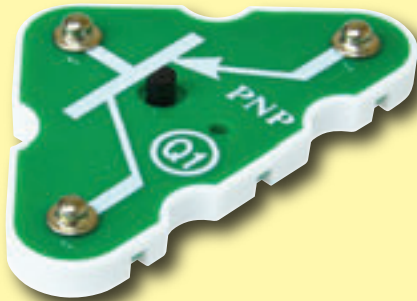

PNP & NPN Transistors (Q1 & Q2)

ALARM IC

The **alarm IC (U2)** contains a specialized sound-generation integrated circuit (IC) and other supporting components (resistors, capacitors, and transistors) that are always needed with it. A schematic for it is available at www.boffin.cz.



Alarm IC (U2)



Connections:

IN1, IN2, IN3 - control inputs
(-) - power return to batteries
OUT - output connection

Connect control inputs to (+) power to make five alarm sounds, see project 169 for an example of proper connections.

LEDs

The **red & green LEDs (D1 & D2)** are light emitting diodes, and may be thought of as a special one-way light bulb. In the "forward" direction, (indicated by the "arrow" in the symbol) electricity flows if the voltage exceeds a turn-on threshold (about 1.5V for red and yellow, about 2.0V for green, and about 3.0V for blue; brightness then increases. A high current will burn out an LED, so your Boffin LEDs have internal resistors to protect them. LEDs block electricity in the "reverse" direction.



Red & Green LEDs (D1 & D2)

The **red/yellow LED (D10)** is like the others but has red and yellow LEDs connected in opposite directions.



Red/Yellow LED (D10)

About Your Boffin Parts

MOTOR MODULES

The **programmable fan (M8)** is a motor with an LED circuit. A motor converts electricity into mechanical motion, in the form of a spinning shaft. In the light motor electricity is transported through the motor shaft to power an LED circuit, with LEDs mounted on the fan blade. The motor spins in both directions, but the light circuit only works in one direction.

How does electricity turn the shaft in the motor? Electricity is closely related to magnetism, and an electric current flowing in a wire has a magnetic field similar to that of a very, very tiny magnet. Inside the motor are three coils of wire with many loops. If a large electric current flows through the loops, the magnetic effects become concentrated enough to move the coils. The motor has a magnet inside, so as the electricity moves the coils to align them with the permanent magnet, the shaft spins.

The LEDs in the fan blade are flashed in a pattern based on the programmed phrase, and synchronized with the motor speed. The flashes are precisely timed and are very brief, but your eyes can't react fast enough and the flashed pattern gives the illusion of words floating in space. You can

change the messages displayed; see project 15. UP, MODE, and DOWN are controlled by connecting those snaps to (-) using switches or the selector (S8).



Programmable Fan (M8)

The **disco motor (DM)** is a motor with a gearbox attached to the shaft, and an LED module mounted on it. The gearbox makes its shaft spin slower but with more force than the shaft that is directly attached to the motor, so it can spin the disco covers. The LED module has red, green, and blue LEDs, connected in parallel.



Disco Motor (DM)

LED DISPLAY & MICROCONTROLLER

The LED MC module (U29) has a dual 7-segment LED display, a microcontroller, and supporting parts. The microcontroller is a mini computer which can be programmed to perform different tasks, including monitoring things and making things happen. It is pre-programmed for use with the games projects. See project 17 for how to select games on it.

LED MC outputs cannot control the motors in the disco motor (DM) or programmable fan (M8) directly, so an interface transistor must be used. LED MC outputs can control your speaker (SP2) and LEDs (D1, D2, D10, and the LEDs in the disco motor) directly.

The Boffin Arcade page on our website (www.boffin.cz) has additional information about the LED MC, including a schematic diagram, the program it is running, links to software that will allow you to modify the program or write your own programs for it, and how to purchase a programming cable for it (which is only needed if you want to reprogram it). The microcontroller used is the PICAXE® 08M2, which has a special programming interface that makes it easy to use. You can also find information about the PICAXE® 08M2 from its manufacturer at www.picaxe.co.uk.



LED MC (U29)

LED MC (U29):

- (+) - Power from batteries
- (-) - Power return to batteries
- S-IN - Takes input from the selector (S8)
- S-OUT - An output, often connected to an LED
- 1 - An output, often connected to an LED
- 2 - An output, usually connected to the speaker
- 3 - Takes input from the selector (S8)
- 4 - An output, often connected to an LED
- D1 - Used to shut off the right LED display
- D2 - Used to shut off the left LED display

Summary of Games in the LED MC (U29)

#	Name	Sample Project	Description	#	Name	Sample Project	Description
1	Arcade	4	Every few seconds it randomly turns on snaps 1, 4, & S-OUT, or plays a tune, or changes the LED display. Used in many projects.	12	Home Run Derby Game	31	A baseball "pitch" occurs where the red, yellow and then green LEDs light up in sequence but at different speeds. You try to press a button at the right moment to "hit" the pitch.
2	Fast Arcade	5	Same as Game 1 but changes faster.				
3	Faster Arcade	5	Same as Game 2 but changes even faster.	13	Baseball Game	32	Same as game 12, but has "outs".
4	Lucky Doubles	18	Rolls dice on the display, doubles plays a winning tune.	14	Memory Game (very easy)	33	A sequence of lights flash, and you try to repeat the order by pressing buttons.
5	Lucky Sixes, Unlucky Ones	19	Rolls dice on the display, 66 plays a winning tune and 11 plays a losing tune.	15	Memory Game (easy)	34	Same as game 14, but the sequence is faster.
6	Risk & Reward	20	Game based on rolling dice on the display.	16	Memory Game (medium)	35	Same as game 14, but the sequence is faster.
7	3 Second Hold	22	Timing game based on holding a button down for 3 seconds.	17	Memory Game (hard)	36	Same as game 14, but the sequence is faster.
8	5 Second Hold	23	Same as Game 7 but for 5 seconds.	18	Memory Game (progressive)	37	Same as game 14, but the sequence gets faster as you play it.
9	10 Second Hold	24	Same as Game 7 but for 10 seconds.	19	Twenty-One	38	A game based on the card game Blackjack.
10	20 Second Hold	25	Same as Game 7 but for 20 seconds.	20	Binary Coded Decimal	40	Uses LEDs to show how numbers 1-7 can be displayed in binary, which has only 2 states.
11	Numbers & Letters	26	Cycles through letters & numbers that can be shown on the display.	21	Changing Speed	43	Turns snaps 1 & 4 on/off at varying speed. Snaps 1 & 4 are always in opposite states. Used in many projects.

Introduction to Electricity

What is electricity? Nobody really knows. We only know how to produce it, understand its properties, and how to control it. Electricity is the movement of sub-atomic charged particles (called **electrons**) through a material due to electrical pressure across the material, such as from a battery.

Power sources, such as batteries, push electricity through a circuit, like a pump pushes water through pipes. Wires carry electricity, like pipes carry water. Devices like LEDs, motors, and speakers use the energy in electricity to do things. Switches and transistors control the flow of electricity like valves and faucets control water. Resistors limit the flow of electricity.

The electrical pressure exerted by a battery or other power source is called **voltage** and is measured in **volts** (V). Notice the “+” and “-” signs on the battery; these indicate which direction the battery will “pump” the electricity.

The **electric current** is a measure of how fast electricity is flowing in a wire, just as the water current describes how fast water is flowing in a pipe. It is expressed in **amperes** (A) or **milliamperes** (mA, 1/1000 of an ampere).

The “**power**” of electricity is a measure of how fast energy is moving through a wire. It is a combination of the voltage and current (Power = Voltage x Current). It is expressed in **watts** (W).

The **resistance** of a component or circuit represents how much it resists the electrical pressure (voltage) and limits the flow of electric current. The relationship is Voltage = Current x Resistance. When the resistance increases, less current flows. Resistance is measured in **ohms** (Ω), or **kilo ohms** ($k\Omega$, 1000 ohms).

Nearly all of the electricity used in our world is produced at enormous generators driven by steam or water pressure. Wires are used to efficiently transport this energy to homes and businesses where it is used. Motors convert the electricity back into mechanical form to drive machinery and appliances. The most important aspect of electricity in our society is that it allows energy to be easily transported over distances.

Note that “distances” includes not just large distances but also tiny distances. Try to imagine a plumbing structure of the same complexity as the circuitry inside a portable radio - it would have to be large because we can't make water pipes so small. Electricity allows complex designs to be made very small.

There are two ways of arranging parts in a circuit, in series or in parallel. Here are examples:

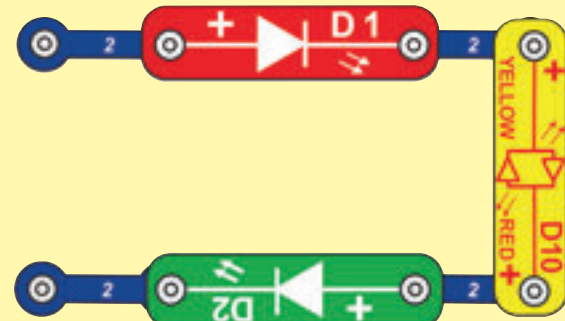

Series Circuit

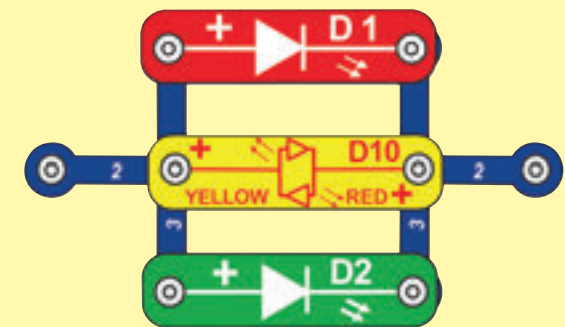

Parallel Circuit

Placing components in series increases the resistance; highest value dominates. Placing components in parallel decreases the resistance; lowest value dominates.

The parts within these series and parallel sub-circuits may be arranged in different ways without changing what the circuit does. Large circuits are made of combinations of smaller series and parallel circuits.

DOs and DON'Ts of Building Circuits

After building the circuits given in this booklet, you may wish to experiment on your own. Use the projects in this booklet as a guide, as many important design concepts are introduced throughout them. Every circuit will include a power source (the batteries), a resistance (which might be a speaker, LED (which has an internal protection resistor), motor, integrated circuit, etc.), and wiring paths between them and back. **You must be careful not to create "short circuits" (very low-resistance paths across the batteries, see examples below) as this will damage components and/or quickly drain your batteries.** Only connect the ICs using configurations given in the projects, incorrectly doing so may damage them. Only connect the programmable fan (M8) using the configurations shown in the projects, otherwise you may damage it or unintentionally erase all messages. **ConQuest entertainment is not responsible for parts damaged due to incorrect wiring.**

Here are some important guidelines:

ALWAYS USE EYE PROTECTION WHEN EXPERIMENTING ON YOUR OWN.

ALWAYS include at least one component that will limit the current through a circuit, such as the speaker, an LED (which has an internal protection resistor), ICs (which must be connected properly), or motor (disco motor or programmable fan).

ALWAYS use switches in conjunction with other components that will limit the current through them. Failure to do so will create a short circuit and/or damage those parts.

ALWAYS disconnect your batteries immediately and check your wiring if something appears to be getting hot.

ALWAYS check your wiring before turning on a circuit.

ALWAYS connect ICs and the programmable fan (M8) using configurations given in the projects or as per the connection descriptions for the parts.

NEVER connect to an electrical outlet in your home in any way.

NEVER leave a circuit unattended when it is turned on.

NEVER touch the programmable fan when it is spinning at high speed.

For all of the projects given in this book, the parts may be arranged in different ways without changing the circuit. For example, the order of parts connected in series or in parallel does not matter — what matters is how combinations of these sub-circuits are arranged together.



Warning to Boffin owners: Do not connect additional voltage sources from other sets, or you may damage your parts. Contact ConQuest entertainment if you have questions or need guidance.

Examples of SHORT CIRCUITS - NEVER DO THESE!!!

Placing a 3-snap wire directly across the batteries is a SHORT CIRCUIT.



NEVER DO!

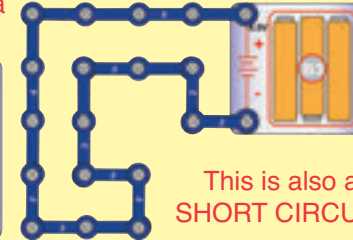
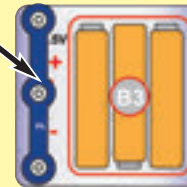

NEVER DO!

This is also a SHORT CIRCUIT.

When the slide switch (S1) is turned on, this large circuit has a SHORT CIRCUIT path (as shown by the arrows). The short circuit prevents any other portions of the circuit from ever working.



NEVER DO!

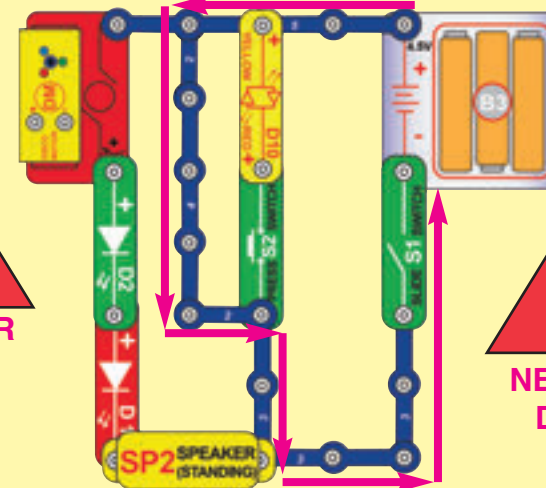

NEVER DO!

You are encouraged to tell us about new programs and circuits you create.

If they are unique, we will post them with your name and state on our website at: www.toy.cz. Send your suggestions to ConQuest entertainment: info@toy.cz.



WARNING: SHOCK HAZARD - Never connect Boffin to the electrical outlets in your home in any way!

Advanced Troubleshooting (Adult supervision recommended)

ConQuest entertainment is not responsible for parts damaged due to incorrect wiring.

If you suspect you have damaged parts, you can follow this procedure to systematically determine which ones need replacing:

1. **Red LED (D1), green LED (D2), red/yellow LED (D10), speaker (SP2), and battery holder (B3):** Place batteries in holder. Place the red/yellow LED directly across the battery holder in both directions, it should light red or yellow depending on which side was positioned towards the battery “+” side. Do the same for the red and green LEDs, but be sure to position their “+” side towards the battery “+” side. “Tap” the speaker across the battery holder contacts, you should hear static as it touches. If none work, then replace your batteries and repeat, if still bad then the battery holder is damaged.

2. **Jumper wires:** Use this mini-circuit to test each jumper wire, the LED should light.

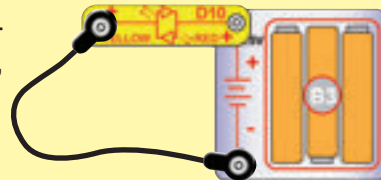

3. **Snap wires:** Use this mini-circuit to test each of the snap wires, one at a time. The LED should light.

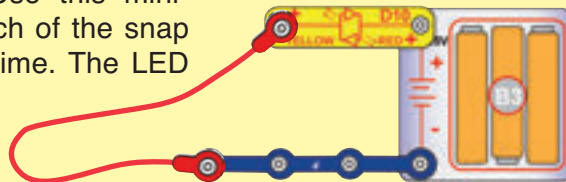

4. **Slide switch (S1) and press switch (S2):** Build project 1; if the red LED (D1) doesn't light then the slide switch is bad. Replace the slide switch with the press switch to test it.

6. **Alarm IC (U2):** Build project 169; you should hear a siren. Variants 1, 2, 3, and 4 should change the sound, but the sound for variant 4 may be the same as one of the others.

7. **PNP transistor (Q1):** Use project 158 to test it.

8. **NPN transistor (Q2):** Use project 159 to test it.

9. **Selector (S8):** Use project 92 to test it.

10. **Disco motor (DM):** Build project 10. The shaft should spin, and red, green, and blue LEDs should light.

11. **Programmable fan (M8):** Connect it as shown in project 15. It should slowly cycle through 6 phrases (unless you erased all messages without programming in new ones). You should be able to change the messages displayed using the instructions in project 15.

Warning: If you erased all messages, then the part will not display any messages until you program in new ones, as per the instructions in project 15.

Note: After several hours of continuous use, the fan message may be erratic, not clear, or even have no display. Turn off for 5 minutes, and it will be back to normal again.

12. **LED-MC (U29, the LED display & microcontroller):** Use project 98 to test it.

ConQuest entertainment a. s.

Kolbenova 961, 198 00 Praha 9,

www.boffin.cz, www.toy.cz

info@boffin.cz

You may order additional / replacement parts at:
www.boffin.cz

Project Listings

Project	Description	Page	Project	Description	Page	Project	Description	Page
1	Red Light	13	35	Memory Game (medium)	26	69	Hex/Pent Light Funky Siren (II)	36
2	Lights	13	36	Memory Game (hard)	26	70	Hex/Pent Light Funky Siren (III)	36
3	Reverse Lights	13	37	Memory Game (progressive)	26	71	Hex/Pent Light Funky Siren (IV)	36
4	Arcade	14	38	Twenty-One	27	72	Random Funky Siren & Lights	36
5	Fast Arcade	14	39	Disco Twenty-One	27	73	Siren Arcade	37
6	New Pattern Arcade	14	40	Binary Coded Decimal	28	74	Siren Arcade (II)	37
7	Arcade Dice	15	41	Blink Rate Changer	29	75	Siren Arcade (III)	37
8	Word Fan	15	42	Click Rate Changer	29	76	Siren Arcade (IV)	37
9	Just the Fan	15	43	Double Changing Blinker	29	77	Siren Arcade (V)	37
10	Disco Ball	16	44	Variable Disco Speed	30	78	Fast Siren Arcade	37
11	Disco Pattern	16	45	Variable Disco Speed Variants	30	79	Disco Siren	38
12	Reverse Disco Ball	16	46	Loud Click Rate Changer	30	80	Disco Machine Gun	38
13	Disco Ball with New Pattern	16	47	Two Speed Disco Ball	30	81	Disco Fire Engine	38
14	Just the Ball	16	48	Bi-Color Light	31	82	Disco European Siren	38
15	Programmable Light Fan	17	49	Bi-Color Light & Sound	31	83	Slow Speed Disco Ball	38
16	Busy Circuit	18	50	Dual Bi-Color Lights	32	84	Slow-Fast Disco	39
17	Games Selector	19	51	Fast Phrase Changer	32	85	Not So Slow-Fast Disco	39
18	Lucky Doubles	19	52	Funky Siren	33	86	Dimmer Disco	39
19	Lucky Sixes, Unlucky Ones	20	53	Funky Siren (II)	33	87	Super-Slow Disco	39
20	Risk & Reward	20	54	Funky Siren (III)	33	88	Slow-Fast Word Fan	40
21	Enhanced Dice Game	21	55	Funky Siren (IV)	33	89	Not So Slow-Fast Word Fan	40
22	3 Second Hold	22	56	Funky Siren (V)	33	90	Slow-Fast Fan	40
23	5 Second Hold	22	57	Funky Siren & Light	34	91	Different Sounds	40
24	10 Second Hold	22	58	Funky Siren & Light (II)	34	92	Selector	41
25	20 Second Hold	23	59	Funky Siren & Light (III)	34	93	Red or Red	41
26	Numbers & Letters	23	60	Funky Siren & Light (IV)	34	94	Green Selector	41
27	Red & Green	23	61	Funky Siren & Light (V)	34	95	Triple Select	41
28	Red & Yellow	23	62	Tri-Light Funky Siren	35	96	Red/Yellow Selector	41
29	Red & Red	23	63	Tri-Light Funky Siren (II)	35	97	Toggle 00	42
30	Green & Yellow	23	64	Tri-Light Funky Siren (III)	35	98	LED-MC Test	42
31	Home Run Derby Game	24	65	Tri-Light Funky Siren (IV)	35	99	Green Light	43
32	Baseball Game	25	66	Tri-Light Funky Siren (V)	35	100	Red/Yellow Light	43
33	Memory Game (very easy)	25	67	Hex-Light Funky Siren	36	101	Pop On, Pop Off	43
34	Memory Game (easy)	26	68	Pent-Light Funky Siren	36	102	Alarm Circuit	44

Project Listings

Project	Description	Page	Project	Description	Page	Project	Description	Page
103	Machine Gun	44	137	Fast Light Projecting Arcade Show	53	171	Red or Yellow & Lots More	66
104	Fire Engine	44	138	Where's the Blue Light?	54	172	Vibrato 2	66
105	European Siren	44	139	There's the Blue Light	54	173	Vibrato 21	66
106	Quieter Alarm Circuit	44	140	No Blue Light	54	174	Random Bi-Color Light	67
107	Quieter Machine Gun	44	141	Dim Green Light	54	175	Random Bi-Color Lights	67
108	Quieter Fire Engine	44	142	Slow Disco Ball	55	176	Arcade Blinking Display	68
109	Quieter European Siren	44	143	Slower Disco Ball	55	177	Blink One	68
110	Fan Flash Energy	45	144	Selector with Disco Motor LEDs	55	178	Triple Light Blink One	68
111	Motor Flash Energy	45	145	Selector with Disco Ball?	56	179	Disco with Sound	69
112	Tri-Light Machine Gun	46	146	Selector with Disco Ball - NPN	56	180	Disco with Sound (II)	69
113	Hex-Light Machine Gun	46	147	Selector with Disco Ball - PNP	57	181	Disco with Sound (III)	69
114	Trip-Wire Alarm	47	148	Slower & Dimmer Disco	57	182	Disco with Sound (IV)	69
115	Trip-Wire Alarm with Better Sound	47	149	Selector with Word Fan	58	183	Disco with Sound (V)	69
116	Trip-Wire Machine Gun	47	150	Select the Fan	58	184	Weird Sound	70
117	Trip-Wire Fire Engine	47	151	Word Fan PNP	59	185	Weird Sound (II)	70
118	Trip-Wire European Siren	47	152	Fan PNP	59	186	Weird Sound (III)	70
119	Water Alarm	48	153	Bi-Color Swing Circuit	59	187	Thyristor Start Disco Ball	70
120	Human Alarm	48	154	Adjusting Disco Cover Focus	60	188	Start Stop Ball	71
121	Draw an Alarm	48	155	Diffused Light	60	189	Sound On by Thyristor	71
122	Water-Human-Drawn Machine Gun	49	156	Your Light Patterns	60	190	Sound On by Thyristor (II)	71
123	Water-Human-Drawn Fire Engine	49	157	Pressure Circuit	60	191	Sound On by Thyristor (III)	71
124	Water-Human-Drawn European Siren	49	158	PNP Transistor	61	192	Sound and Light On-Off Thyristor	72
125	Yellow & More	49	159	NPN Transistor	61	193	Fan On-Off	72
126	Red & More	49	160	6-Sided Dice Game: Race to the Finish	62	194	Add One	73
127	Green & More	49	161	6-Sided Dice Game: Difference Maker	62	195	Add 10	73
128	Random Siren Selector	50	162	6-Sided Dice Game: Don't Go Low	62	196	Add One at a Time	73
129	Fast Random Siren Selector	50	163	6-Sided Dice Game: Free the Frogs	63	197	+1 Beeper	74
130	LED Random Siren Selector	50	164	6-Sided Dice Game: Free the Fish	63	198	Counting Sound	74
131	5-LED Random Siren Selector	50	165	6-Sided Dice Game: Free the Foxes	63	199	Another Counting Sound	74
132	Disco Arcade Show	51	166	6-Sided Dice Game: Squares	64	200	Push-Start Disco	75
133	Fast Disco Arcade Show	51	167	6-Sided Dice Game: Coin Dice	64	201	Faster Push-Start Disco	75
134	Word Fan Arcade Show	52	168	6-Sided Dice Game: Baseball	65	202	Medium Speed Disco	75
135	Fast Word Fan Arcade Show	52	169	Simple Alarm Sounds	65	203	Finale	76
136	Light Projecting Arcade Show	53	170	Green & Lots More	66			



Project 1

Red Light

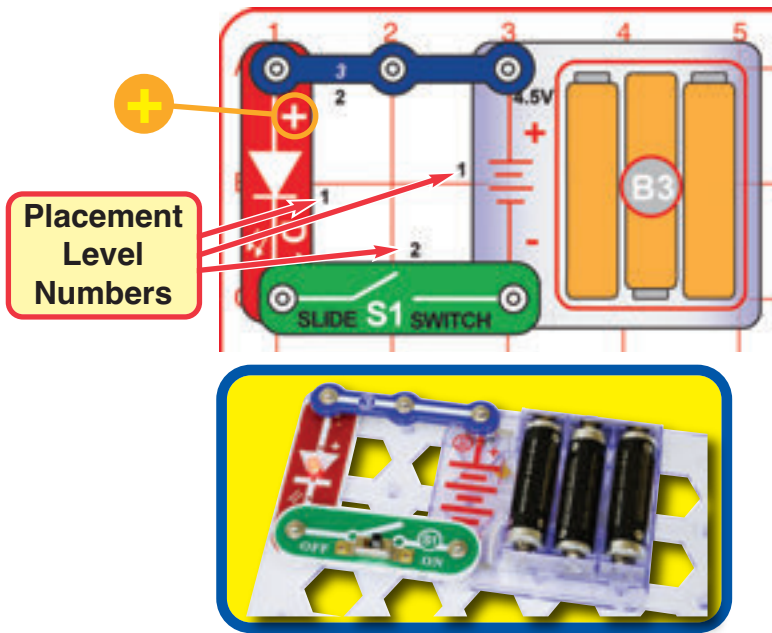

Boffin uses electronic blocks that snap onto a clear plastic grid to build different circuits. These blocks have different colors and numbers on them so you can easily identify them.

Build the circuit shown on the left by placing all the parts with a black 1 next to them on the board first. Then, assemble parts marked with a 2. Install three (3) "AA" batteries (not included) into the battery holder (B3) if you have not done so already.

Turn on the slide switch (S1), and the red LED (D1) lights.

Snappy says when you turn on the slide switch, electricity flows from the batteries, through the red LED and back to the battery through the switch. If the switch is off, the flow of electricity is blocked, and the red LED won't light.



NOTE: this circuit (and many others in this book) have an LED being used without a resistor or other component to limit the electric current through it. Normally this could damage an LED but your Boffin LEDs include internal protection resistors, and will not be damaged. Be careful if you later use other electrical sets with unprotected LEDs.



Project 2

Lights

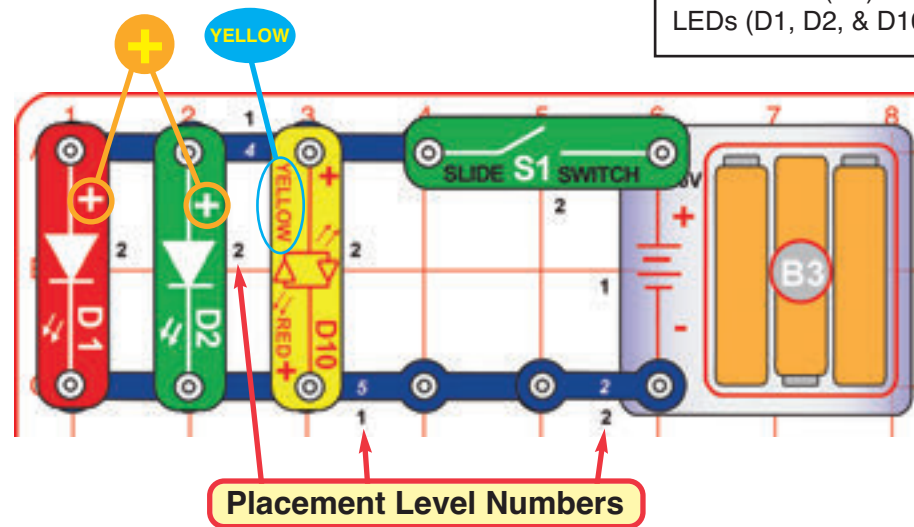

Build the circuit shown here and turn on the slide switch (S1). The red, green, and yellow LEDs (D1, D2, & D10) light.

LEDs are light emitting diodes, which convert electrical energy into light. The color of the light depends on the characteristics of the material used in them.



Project 3

Reverse Lights

Try reversing the position of the slide switch (S1), 2-snap wire, and each of the LEDs (D1, D2, & D10), separately.



Reversing the slide switch and 2-snap wire has no effect. LEDs only work in one direction, so the red & green LEDs do not work in reverse, but the yellow LED (D10) is a bi-color LED, with separate red & yellow LEDs in opposite directions, as shown in its symbol.



Project 4

Arcade

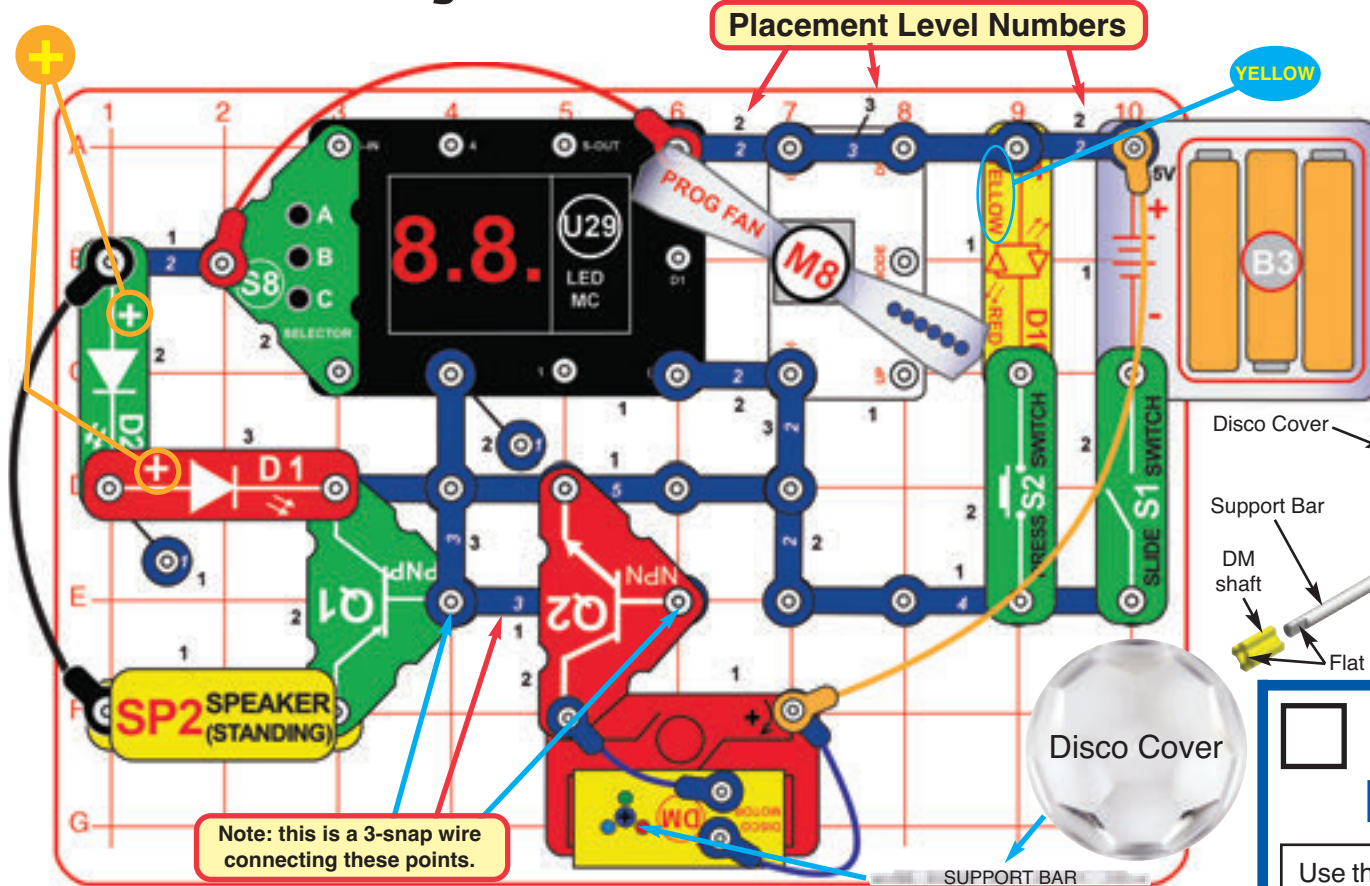

Placement Level Numbers

YELLOW

This circuit is shown on the front of the Boffin Arcade box. Use that picture to help in building it.

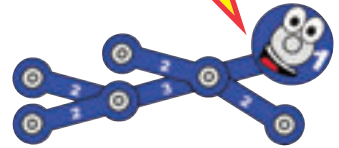

Disco Cover Assembly

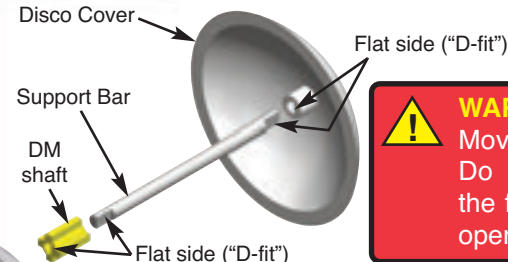

WARNING: Moving parts. Do not touch the fan during operation.

Note: this is a 3-snap wire connecting these points.

Build the circuit shown above by placing all the parts with a black 1 next to them on the board first. Then, place parts marked with a 2, and then parts with a 3. Connect the jumper wires (red, black, orange, and blue) as shown in the drawing. Install three (3) "AA" batteries (not included) into the battery holder (B3) if you have not done so already. Place the disco cover support bar on the disco motor (DM) shaft, and place one of the disco covers on it; note that both sides of the support bar are "D-fit".

Turn on the slide switch (S1). The programmable fan (M8) spins, the red & green LEDs (D1 & D2) light, and the display on the LED-MC (U29) displays "00". Push

the press switch (S2) to light the yellow LED (D10).

Make the display on the LED-MC show "01" by pressing the A button on the selector (S8) to increase the ones digit on the display. Press the B button on the selector to select the game (now game 1), and a mini arcade show begins.

Every few seconds the speaker plays a tune while the disco motor spins & lights, and/or the U29 LED display shows a random pattern.

If you want to change games then turn off S1 to reset the circuit. You can make the sound louder by removing the disco motor and NPN transistor (Q2).

Project 5 Fast Arcade

Use the project 4 circuit but select game 2 or 3 (instead of game 1). Some parts of the arcade show happen faster now, such as the changing random pattern on the U29 LED display.

Project 6 New Pattern Arcade

Use the project 4 circuit (with game 1, 2, or 3), but replace the disco cover with the other one that is included. Place the circuit in a dark room for best effects.

Project 7 Arcade Dice

Use the project 4 circuit but select game 4 (instead of game 1), then press button B. When the display shows "Go" press button B to start the game.

- Hold down button C for a few seconds and then release it.
- Two random digits from 1 to 6 will be shown on the display (like rolling 2 dice).
- If the player rolls "doubles" (i.e. the two digits are the same), a winning song will be played, the disco motor (DM) spins & lights, and the game starts over ("Go" is shown on the display again).
- If the player does not roll "doubles", then they can keep trying by pressing button C again.

Project 8

Word Fan

Turn on the slide switch (S1). The programmable fan (M8) spins and slowly displays messages. See project 15 if you want to change the messages.

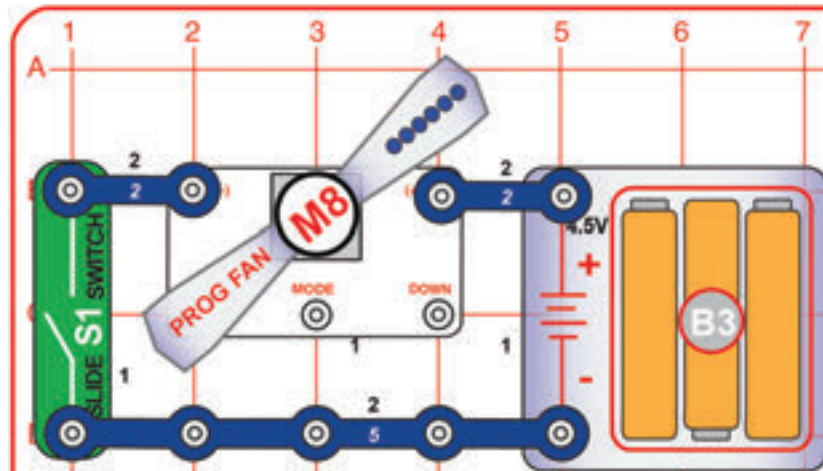

WARNING: Moving parts. Do not touch the fan while it is spinning.

Project 9

Just the Fan

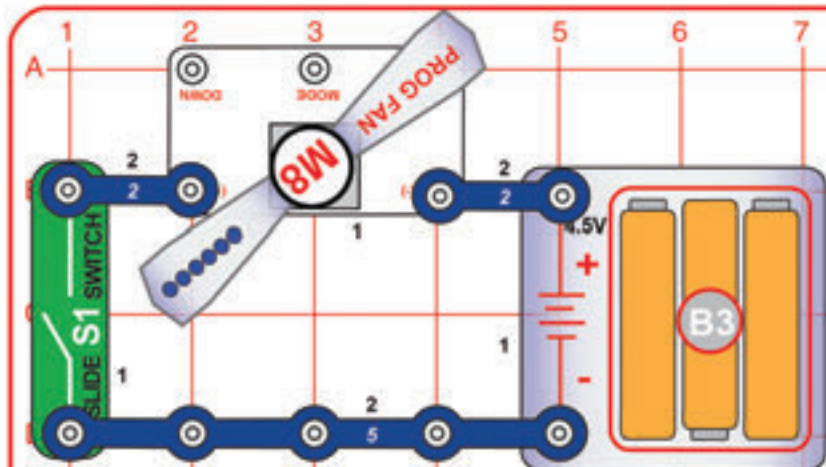

Turn on the slide switch (S1). The programmable fan (M8) just spins, without displaying any messages.

This circuit is like the Word Fan circuit except the voltage to the programmable fan is reversed. The motor works but spins the fan in the opposite direction. The lights on the fan are off, because the microcircuit controlling them doesn't function when the voltage to it is reversed.

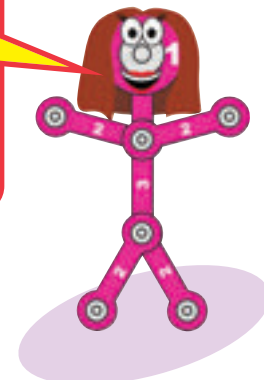

WARNING: Moving parts. Do not touch the fan while it is spinning.

Project 10

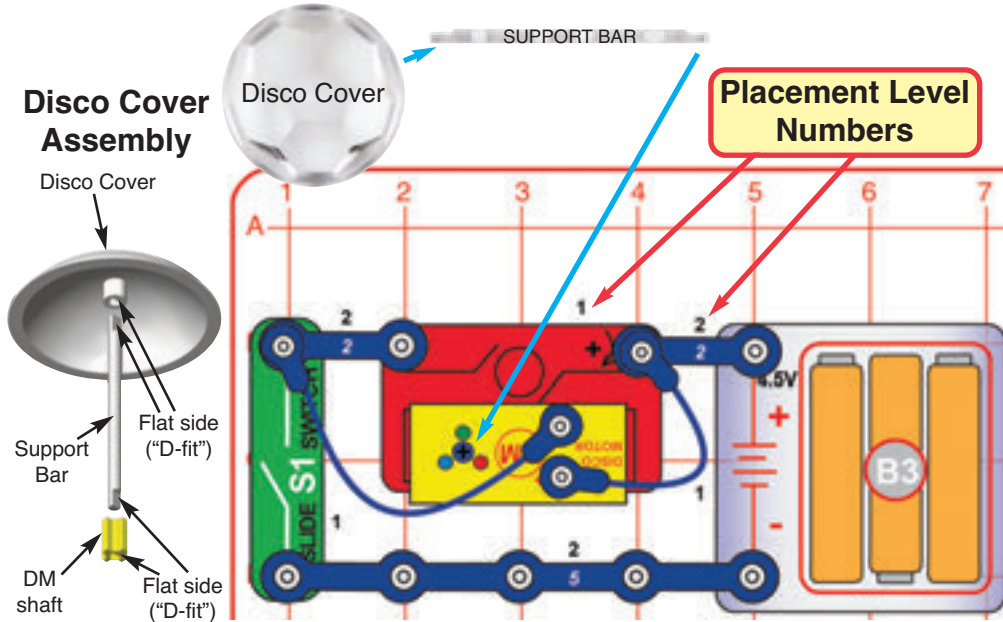

Disco Ball

Build the circuit shown on the left by placing all the parts with a black 1 next to them on the board first. Then, assemble parts marked with a 2. Connect the two blue jumper wires to the snaps on top of the disco motor (DM). Install three (3) "AA" batteries (not included) into the battery holder (B3) if you have not done so already. Place one of the disco covers on the disco motor shaft. Note that both sides of the support bar are "D-fit".

Turn on the slide switch (S1) and watch the show. Place in a dark room for best effects.

You can make the disco cover spin more slowly in projects 83-87, 142, and 200-202.

Project 11

Disco Pattern

Use the preceding circuit, but remove the 2-snap wire between the slide switch (S1) and disco motor (DM); connect the end of the blue jumper wire directly to S1. Place in a dark room and look at the pattern on the ceiling. The disco cover does not spin.

Project 12 Reverse Disco Ball



This circuit is like project 10, but the disco cover spins in the opposite direction.

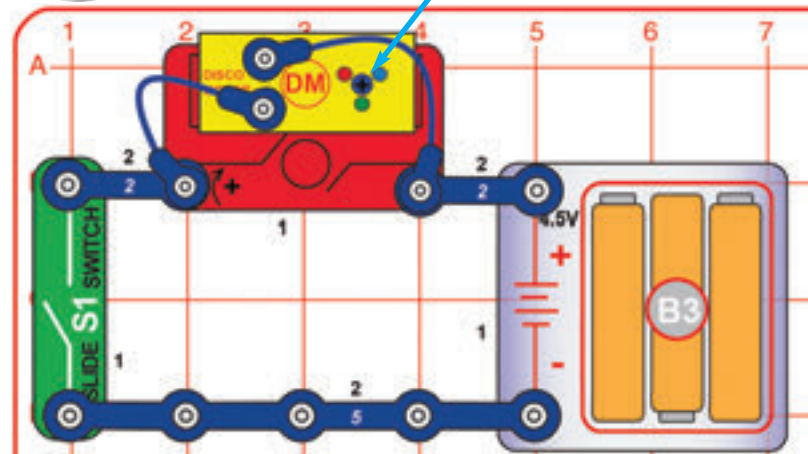

In this circuit we reversed the battery connections to the disco motor (DM), so its shaft spins in the opposite direction now. The connections to the LEDs in the disco motor were not changed.

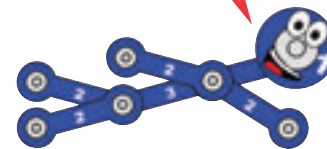

Project 13 Disco Ball with New Pattern

Use any of the three preceding circuits, but replace the disco cover with the other one included in this set. Compare the patterns on the ceiling. Place in a dark room for best effects.

Project 14 Just the Ball

Use any of the project 10, 12, or 13 circuits, but remove the two blue jumper wires. Now the lights do not work, so you just have a spinning disco cover.



Project 15

Programmable Light Fan

Note that there is a 3-snap wire under the selector (S8) that is partially hidden. Turn on the slide switch (S1). The programmable fan (M8) spins and slowly displays messages.

Button	Controls	Description
A (on S8)	UP	Press & hold to ERASE ALL MESSAGES .
S2	MODE	Press & hold to enter PROGRAM MODE.
C (on S8)	DOWN	Press to move to the next message.

Button Functions in NORMAL MODE:

Button B (on S8) does nothing.
Erased messages can only be restored by re-entering them.

Button Functions in PROGRAM MODE:

Button	Controls	Description
A (on S8)	UP	Press to find the letter you want upwards. Press & hold to find quickly.
S2	MODE	Press to move to the next space. Press & hold to save ready letters or exit.
C (on S8)	DOWN	Press to find the letter you want downward. Press & hold to find quickly.

Button B (on S8) does nothing.

Operation:

1. Use the slide switch (S1) to turn it on. The fan will display the message set last time. If it's the first time, the fan will display the initial set (these are subject to change):

- | | | |
|------------------|-------------------|---------------|
| 1 BOFFIN | 2 ARCADE | 3 BY CQE |
| 4 LEARN BY DOING | 5 FUN ELECTRONICS | 6 YOUR PHRASE |

2. To program the messages, press the "DOWN" button to select the phase and program the message as per the following steps:

- Press & hold the "MODE" button to enter the "PROGRAM MODE". When the cursor is blinking, you can edit the first letter.
- Press the "UP" or "DOWN" button to find the letter you want. Hold the button down to change letters faster.
- Each phase can contain 15 letters. Press the "MODE" button to edit the next space.
- Press & hold the "MODE" button to save the message and exit from editing mode.

3. If you want to edit another message, press the "DOWN" button and select the phase and repeat the above steps.

4. In NORMAL MODE, press & hold the "UP" button to **ERASE ALL MESSAGES**. Turn off and on, **it will not display any message** until you program one.

5. Letters and marks available:

A B C D E F G H I J K L M N O P Q R S T U V W X Y Z

♥ ★ , : ! ? . () @ ° # + - × ÷ = ≠ \$ ¥ € £ & 1 2 3 4 5 6 7 8 9 0 ■ Remark: "■" means space.

Note: After several hours of continuous use, the fan message may be erratic, not clear, or even have no display. Turn off for 5 minutes, and it will be back to normal again.

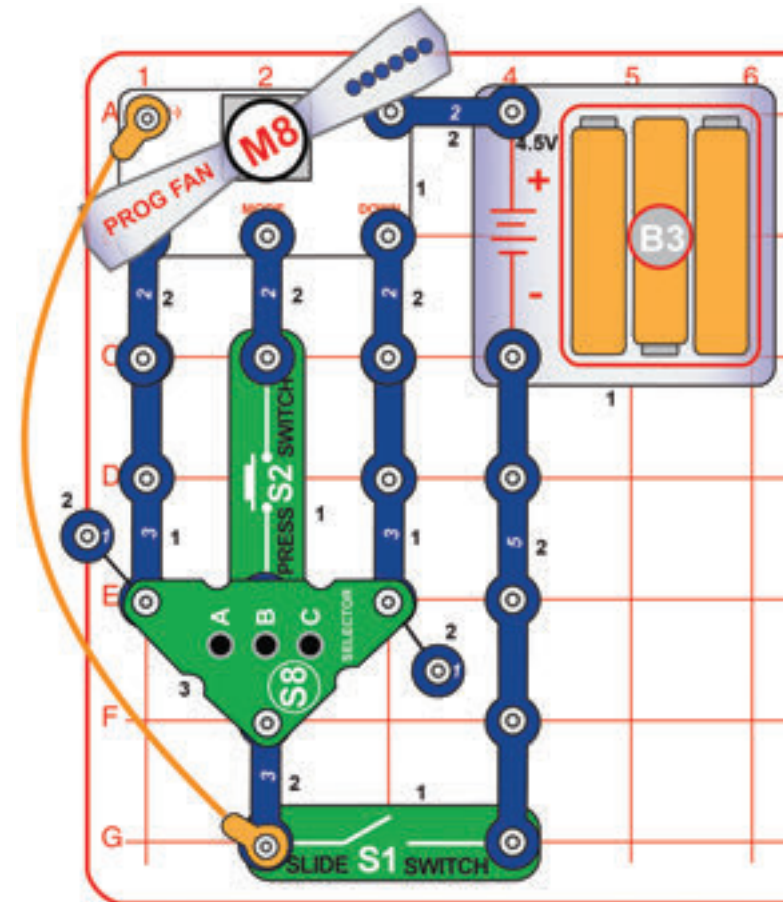

WARNING: Moving parts. Do not touch the fan while it is spinning.



Project 17

Games Selector

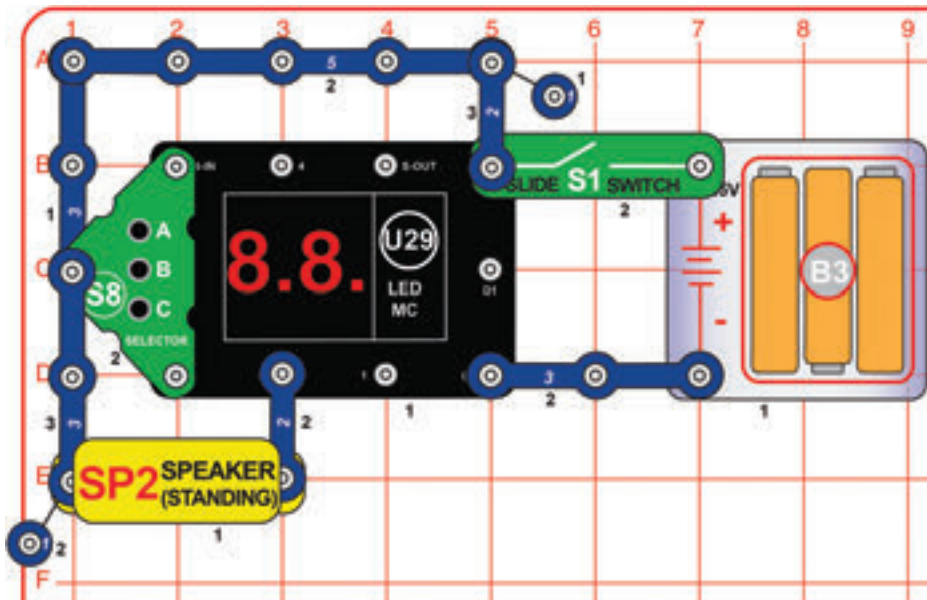

This simple circuit is intended as an introduction for how to select games on the LED-MC (U29).

Turn on the slide switch (S1); the display on the LED-MC shows "00". Press the A button on the selector (S8) to increase the ones digit on the display, and press the C button on the selector (S8) to increase the tens digit on the display. When the display shows the game number you want, press the B button on the selector to select it; you hear a beep and the display shows "Go" for most games.

Notes:

- There are 21 games available, but most cannot be played with this simple circuit, or would only have limited features.
- If you try to select a game number higher than 21, then the display will be reset to "00".
- When the player wins, loses, or finishes a game, the display will say "Go" again and the player can play the game again.
- The only way to select a different game is by turning off the circuit and then turning it back on so that "00" appears on the display again.

Now you are ready to play games!



Project 18

Lucky Doubles

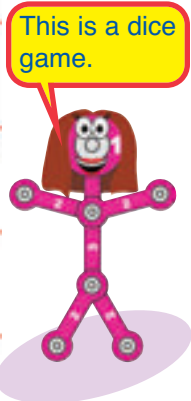
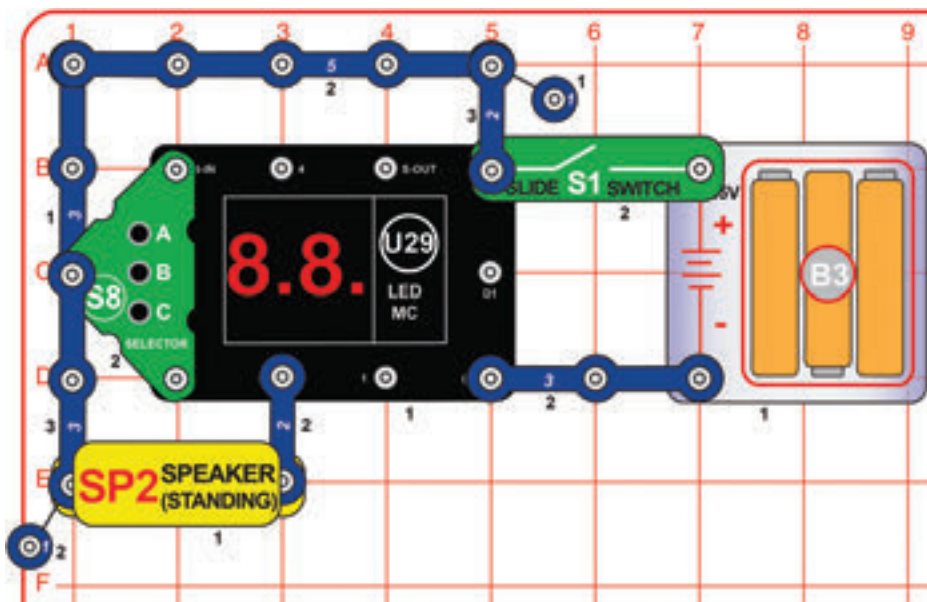

Use this circuit but select Game 4 using the game selection procedure in project 17.

Once the player selects Game 4 and sees "Go" on the display, then:

- Hold down button C for a few seconds and then release it.
- Two random digits from 1 to 6 will be shown on the display (like rolling 2 dice).
- If the player rolls "doubles" (i.e. the two digits are the same), a winning song will be played and the game starts over ("Go" is shown on the display again).
- If the player does not roll "doubles", then they can keep trying by pressing button C again.
- Have multiple people play to see who is the first to roll "doubles", or who can roll the most "doubles" in 10 tries.



Project 19

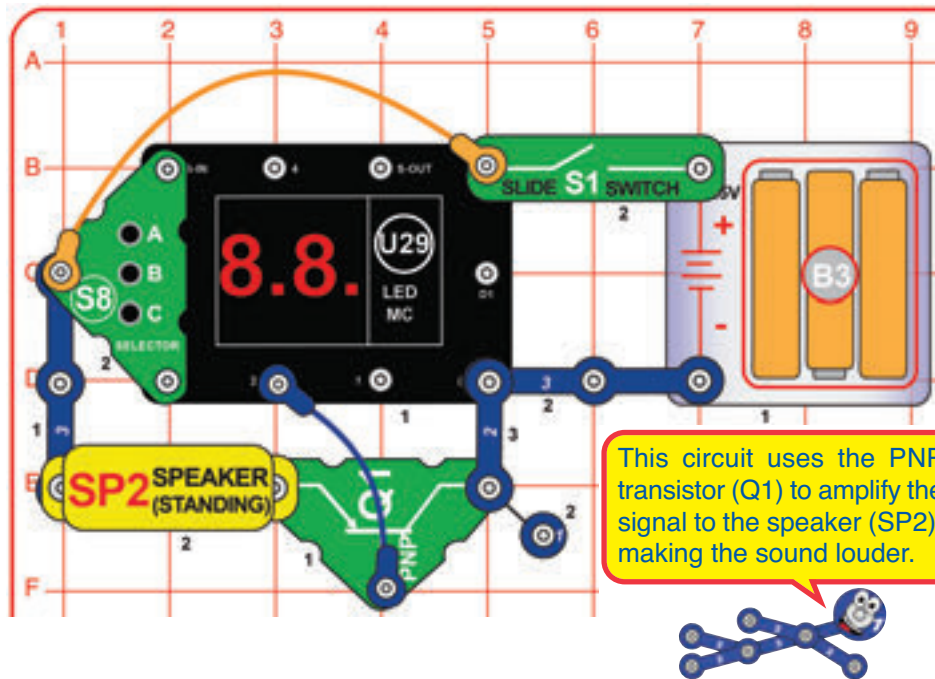

Lucky Sixes, Unlucky Ones

Use the Project 18 circuit or this one (which is louder), but select Game 5 using the game selection procedure in project 17.

Once the player selects Game 5 and sees “Go” on the display, then:

- Hold down button C for a period of time and then release it.
- When button C is released, two random digits from 1 to 6 will be shown on the display (like rolling 2 dice).
- If the player rolls “double sixes” (i.e. 66 on the display), a winning song will be played and the game starts over (“Go” is shown on the display again).
- If the player rolls “double ones” (i.e. 11 on the display), a losing song will be played and the game starts over (“Go” is shown on the display again).
- If the player does not roll 66 or 11, then they can keep playing by pressing button C again.
- Have multiple people play to see who is the first to roll 66, with those rolling 11 being eliminated from the game.



Project 20

Use the Project 18 or Project 19 circuit but select Game 6 using the game selection procedure in project 17.

Once the player selects Game 6 and sees “Go” on the display, then:

- Hold down button C for a period of time and then release it.
- When button C is released, two random digits from 1 to 6 will be shown on the display (like rolling 2 dice).
- If either of the digits is a 1, then a losing sound will be played and the player gets 0 points for that turn. “Go” is then displayed for the next players turn.
- If neither of the digits is a 1, then the player has two options:
 - ◆ Player can press button A and score the sum of the two digits on the display. A winning song will be played and the players score will be displayed for a few seconds. “Go” is then displayed for the next players turn.

OR

Risk & Reward

- ◆ Player can decide to go for more points by holding button C again for a period of time. After releasing button C again:
 - ▶ If the player rolled a 1 in either digit, then a losing song will be played and the player gets 0 points for that turn (they lose all the points from their previous rolls). “Go” is then displayed for the next players turn.
 - ▶ If the player again did not roll a 1 in either of the digits, then the sum of the digits will be added to the players score from previous rolls and they will again have a chance to decide whether to take the points they have accumulated (by pressing button A) or go for even more points (by holding button C again for a period of time).
 - ▶ When the player decides to hit button A after multiple rolls, a winning song will be played and the sum of the players previous rolls will be displayed for a few seconds. “Go” is then displayed for the next players turn.
- See how few turns you need to get 50 points. Are you lucky enough to get 50 in one turn?
- Have multiple people play. Write down your scores after each turn and see who is the first one to get to 100.



Project 21

Enhanced Dice Game

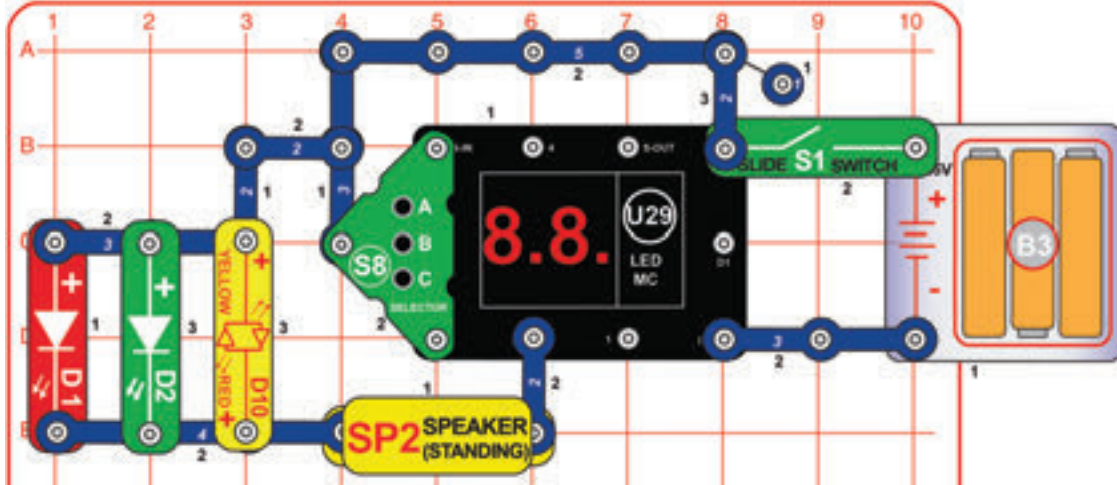

Use this circuit but select Game 4 using the game selection procedure in project 17.

Once the player selects Game 4 and sees “Go” on the display, then

- Hold down button C for a few seconds and then release it.
- Two random digits from 1 to 6 will be shown on the display (like rolling 2 dice).
- If the player rolls “doubles” (i.e. the two digits are the same), a winning song will be played and the game starts over (“Go” is shown on the display again).
- If the player does not roll “doubles”, then they can keep trying by pressing button C again.
- Have multiple people play to see who is the first to roll “doubles”, or who can roll the most “doubles” in 10 tries.

Alternate circuit (a little louder):

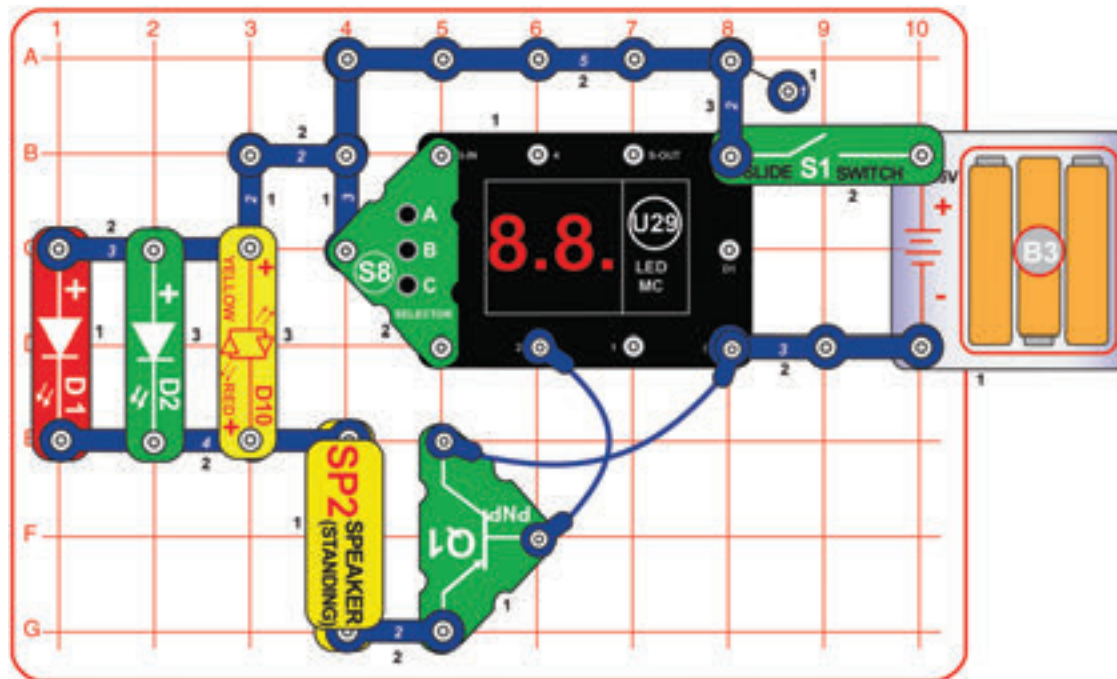

This circuit is like project 18 (Lucky Doubles), but adds more LEDs for extra effects, and the sound is not as loud.

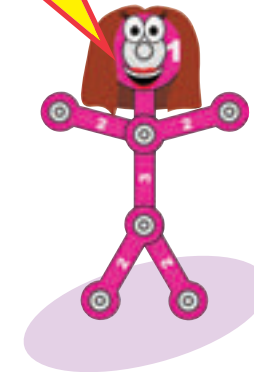



Project 22

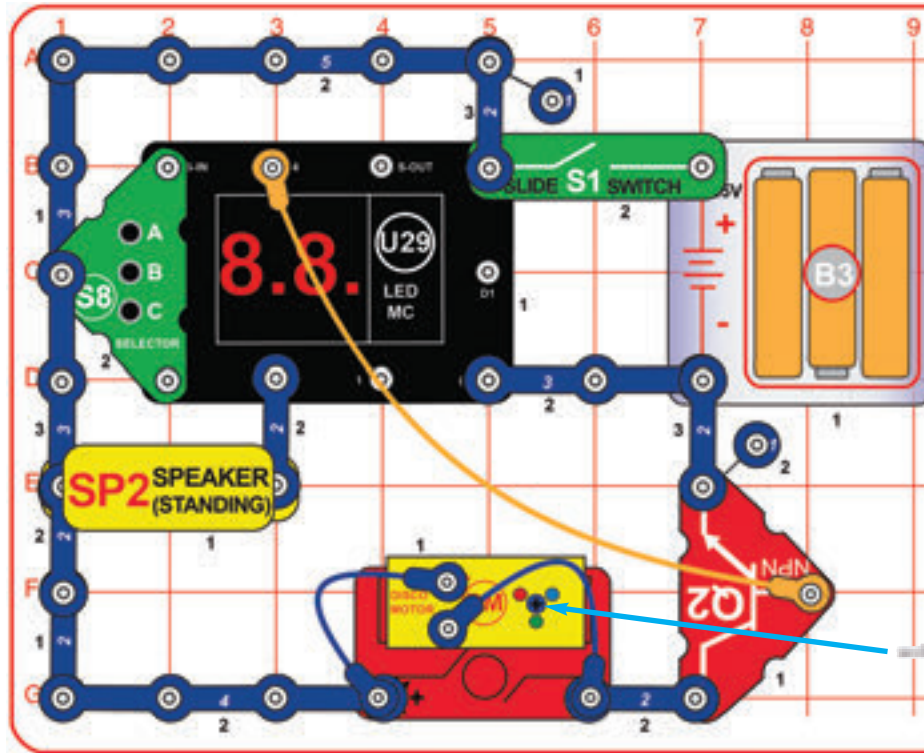

3 Second Hold

Use this circuit but select Game 7 using the game selection procedure in project 17.

Once the player selects Game 7 and sees “Go” on the display, then:

- Try to hold down button C for exactly 3 seconds, then release button C.
- The display will show the number of seconds the player held button C down.
- If the player held button C down for 3 seconds, a winning song will play while the disco cover spins, and the game starts over (“Go” is displayed to play the game again). The disco cover will stop spinning when you press C again.
- If the player held button C down for less than 3 seconds or more than 3 seconds, a losing song will play and the game starts over (“Go” is displayed to play the game again).
- Play with multiple people to see who is the first to hold the button for exactly 3 seconds.



This is a timing game.

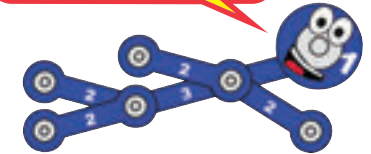

Project 23 5 Second Hold

Use the Project 22 circuit, but select Game 8 using the game selection procedure in project 17.

Once the player selects Game 8 and sees “Go” on the display, then:

- Try to hold down button C for exactly 5 seconds, then release button C.
- The display will show the number of seconds the player held button C down.
- If the player held button C down for 5 seconds, a winning song will play while the disco cover spins, and the game starts over (“Go” is displayed to play the game again). The disco cover will stop spinning when you press C again.
- If the player held button C down for less than 5 seconds or more than 5 seconds, a losing song will play and the game starts over (“Go” is displayed to play the game again).
- Play with multiple people to see who is the first to hold the button for exactly 5 seconds.



Project 24 10 Second Hold

Use the Project 22 circuit, but select Game 9 using the game selection procedure in project 17.

Once the player selects Game 9 and sees “Go” on the display, then:

- Try to hold down button C for exactly 10 seconds, then release button C.
- The display will show the number of seconds the player held button C down.
- If the player held button C down for 10 seconds, a winning song will play while the disco cover spins, and the game starts over (“Go” is displayed to play the game again). The disco cover will stop spinning when you press C again.
- If the player held button C down for less than 10 seconds or more than 10 seconds, a losing song will play and the game starts over (“Go” is displayed to play the game again).
- Play with multiple people to see who is the first to hold the button for exactly 10 seconds.

Project 25

20 Second Hold

Use the Project 22 circuit, but select Game 10 using the game selection procedure in project 17.

Once the player selects Game 10 and sees "Go" on the display, then:

- Try to hold down button C for exactly 20 seconds, then release button C.
- The display will show the number of seconds the player held button C down.
- If the player held button C down for 20 seconds, a winning song will play while the disco cover spins, and the game starts over ("Go" is displayed to play the game again). The disco cover will stop spinning when you press C again.
- If the player held button C down for less than 20 seconds or more than 20 seconds, a losing song will play and the game starts over ("Go" is displayed to play the game again).
- Play with multiple people to see who is the first to hold the button for exactly 20 seconds.

Project 27

Red & Green

Turn on the slide switch (S1) to light the LEDs (D1 & D2).

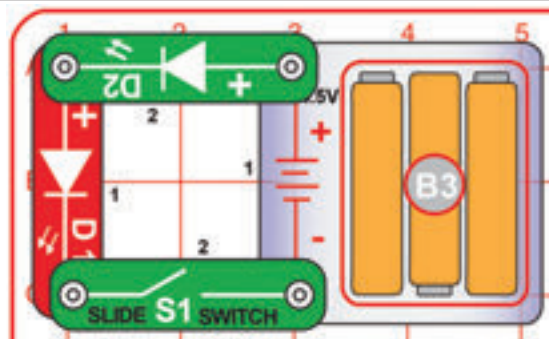

Project 26 Numbers & Letters

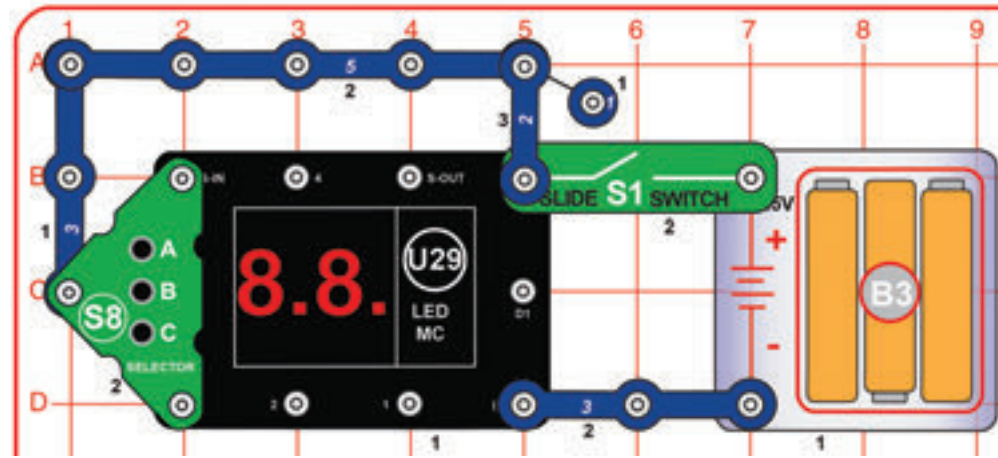

Use this circuit but select Game 11 using the game selection procedure in project 17.

Once the player selects Game 11 and sees "Go" on the display, then:

- Press button C, and a 0 is shown on the display.
- Press button C again, and a 1 is shown on the display.
- Continuing to press button C will cycle through the typical numbers and letters that can be shown on the display.
- Not all the letters in the alphabet can be easily created on the display since they are only 7-segment displays...can you identify which letters are missing? One letter is skipped because a certain number looks the same...can you identify what letter/number this is?

Project 28

Red & Yellow

Use the preceding circuit, but replace the green LED (D2) with the red/yellow LED (D10) yellow "+" on the right.

Project 29

Red & Red

Use the preceding circuit, but reverse the red/yellow LED (D10), so the red "+" is on the right.

Project 30

Green & Yellow

Use the project 27 circuit, but replace the red LED (D1) with the red/yellow LED (D10), yellow "+" on top.



Project 31

Home Run Derby Game

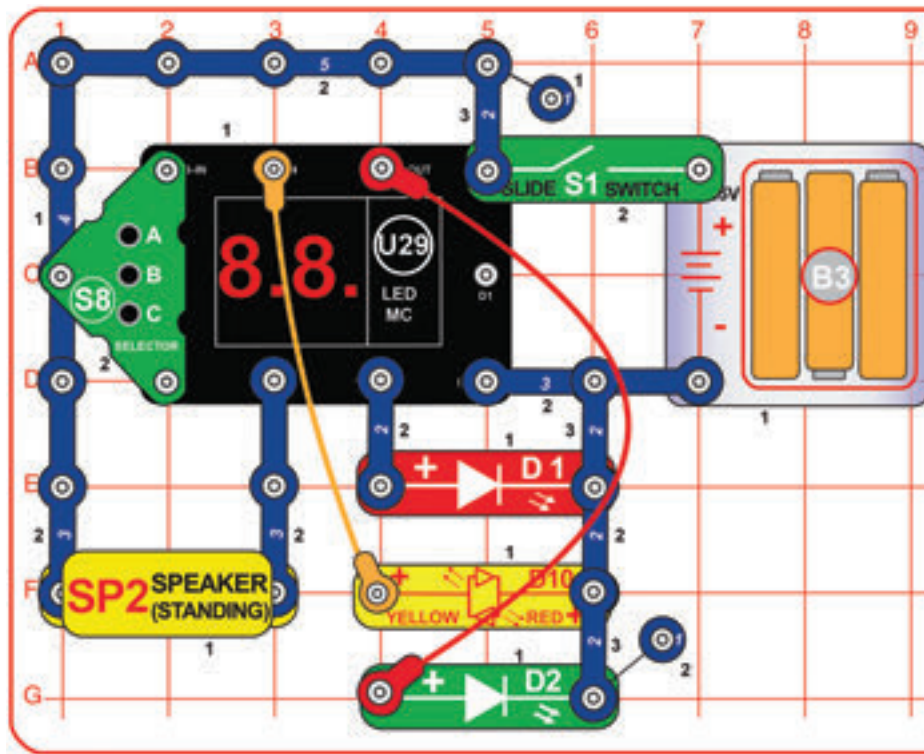

Use this circuit but select Game 12 using the game selection procedure in project 17.

Once the player selects Game 12 and sees “Go” on the display, then:

- Press & release button B, and the derby will begin.
- A baseball pitch occurs where the red, yellow, and then green LEDs light up in sequence but at different speeds.
- The player needs to press button B at just the right time (after the green LED is displayed) to hit a home run.
- If the player presses button B at just the right time, a winning song will play, the crowd will cheer, and the display will increase to indicate the number of home runs the player has. The next pitch will come automatically.
- If the player presses button B at the wrong time (either too late or too early), then a losing song will play and the display will flash the number of outs (or misses) the player has for a few seconds, and then go back to displaying the number of home runs the player has so far. The next pitch will come automatically.
- Once the player gets 10 outs, a losing song will play, the total number of home runs the player got is displayed for a few seconds, then the game starts over (“Go” is displayed until the next player presses button B).
- See who can get the most home runs before getting 10 outs!

Alternate connections for speaker (a little louder):

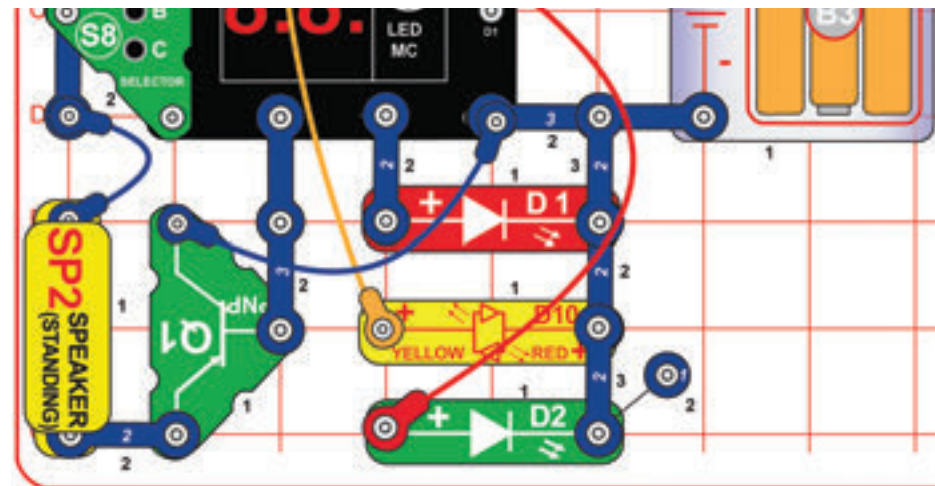



Project 32

Baseball Game

Use the Project 31 circuit but select Game 13 using the game selection procedure in project 17.

Once the player selects Game 13 and sees “Go” on the display, then:

- Press & release button B, and the derby will begin.
- A baseball pitch occurs where the red, yellow, and then green LEDs light up in sequence but at different speeds.
- The player needs to press button B at just the right time (after the green LED is displayed) to hit a home run.
- If the player presses button B at just the right time, a winning song will play, the crowd will cheer, and the display will increase to indicate the number of home runs the player has in the current inning. The next pitch will come automatically.

- If the player presses button B at the wrong time (either too late or too early), then a losing song will play and the display will flash the number of outs the player has for a few seconds, and then go back to displaying the number of home runs the player has so far in the inning. The next pitch will come automatically.
- Once the player gets 3 outs, a losing song will play, the total number of home runs the player got in the inning is displayed for a few seconds, then the game starts over to go to the next inning (“Go” is displayed until the next player presses button B).
- Write down your scores after each inning and play a 9 inning game to see who scores the most runs!



Project 33

Memory Game (very easy)

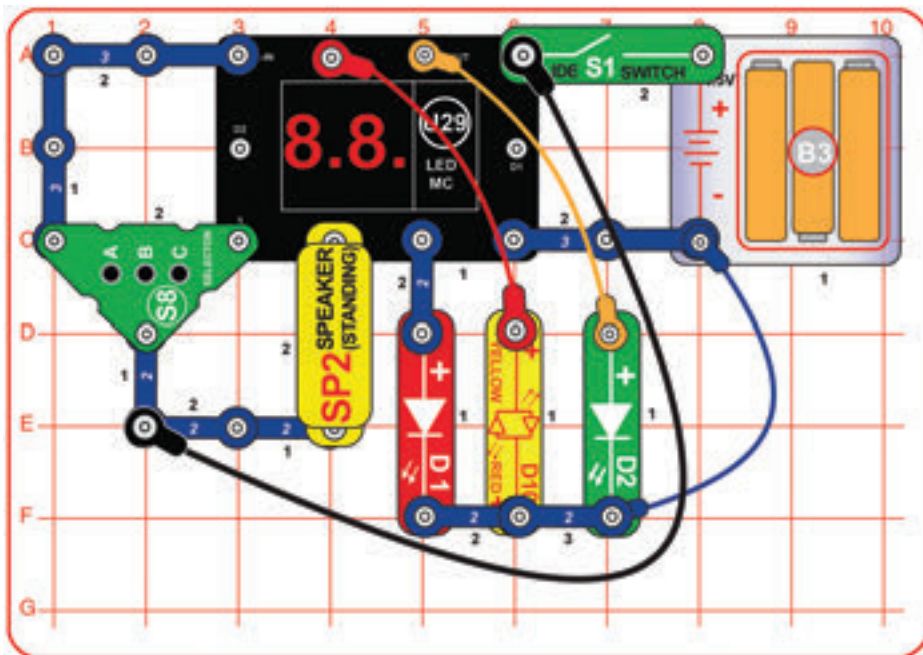

Use this circuit but select Game 14 using the game selection procedure in project 17.

Once the player selects Game 14 and sees “Go” on the display, then:

- Press button B and the game will begin.
- A random sequence of lights will slowly flash and then the player has to repeat that sequence in the correct order by pressing button A for the Red LED, button B for the Yellow LED, and button C for the Green LED.
- If the player gets 3 in a row right, the winning song will play, LEDs will flash, the U29 LED display will say “oh YA”, and the game will start over (“Go” will appear on the display).
- If the player enters the wrong sequence at any point, the losing song will play and the U29 LED display will say “oh no”, and the game will start over (“Go” will appear on the display).

□ **Project 34** **Memory Game (easy)**

Use the Project 33 circuit, but select Game 15 using the game selection procedure in project 17.

Once the player selects Game 15 and sees “Go” on the display, then:

- Press button B and the game will begin.
- A random sequence of lights will slowly flash and then the player has to repeat that sequence in the correct order by pressing button for the Red LED, button B for the Yellow LED, and button C for the Green LED.
- If the player gets 8 in a row right, the winning song will play, LEDs will flash, the U29 LED display will say “oh YA”, and the game will start over (“Go” will appear on the display).
- If the player enters the wrong sequence at any point, the losing song will play and the U29 LED display will say “oh no”, and the game will start over (“Go” will appear on the display).

□ **Project 35** **Memory Game (medium)**

Use the Project 33 circuit, but select Game 16 using the game selection procedure in project 17.

Once the player selects Game 16 and sees “Go” on the display, then:

- Press button B and the game will begin.
- A random sequence of lights will quickly flash and then the player has to repeat that sequence in the correct order by pressing button A for the Red LED, button B for the Yellow LED, and button C for the Green LED.
- If the player gets 8 in a row right, the winning song will play, LEDs will flash, the U29 LED display will say “oh YA”, and the game will start over (“Go” will appear on the display).
- If the player enters the wrong sequence at any point, the losing song will play and the U29 LED display will say “oh no”, and the game will start over (“Go” will appear on the display).

□ **Project 36** **Memory Game (hard)**

Use the Project 33 circuit, but select Game 17 using the game selection procedure in project 17.

Once the player selects Game 17 and sees “Go” on the display, then:

- Press button B and the game will begin.
- A random sequence of lights will quickly flash and then the player has to repeat that sequence in the correct order by pressing button A for the Red LED, button B for the Yellow LED, and button C for the Green LED.
- If the player gets 12 in a row right, the winning song will play, LEDs will flash, the U29 LED display will say “oh YA”, and the game will start over (“Go” will appear on the display).
- If the player enters the wrong sequence at any point, the losing song will play and the U29 LED display will say “oh no”, and the game will start over (“Go” will appear on the display).

□ **Project 37** **Memory Game (progressive)**

Use the Project 33 circuit, but select Game 18 using the game selection procedure in project 17.

Once the player selects Game 18 and sees “Go” on the display, then:

- Press button B and the game will begin.
- A random sequence of lights will flash and then the player has to repeat that sequence in the correct order by pressing button A for the Red LED, button B for the Yellow LED, and button C for the Green LED.
- The random sequence of lights will start out slowly flashing, but the speed at which they flash will increase progressively the further into the game the player gets.
- If the player gets 12 in a row right, the winning song will play, LEDs will flash, the U29 LED display will say “oh YA”, and the game will start over (“Go” will appear on the display).
- If the player enters the wrong sequence at any point, the losing song will play and the U29 LED display will say “oh no”, and the game will start over (“Go” will appear on the display).



Project 38

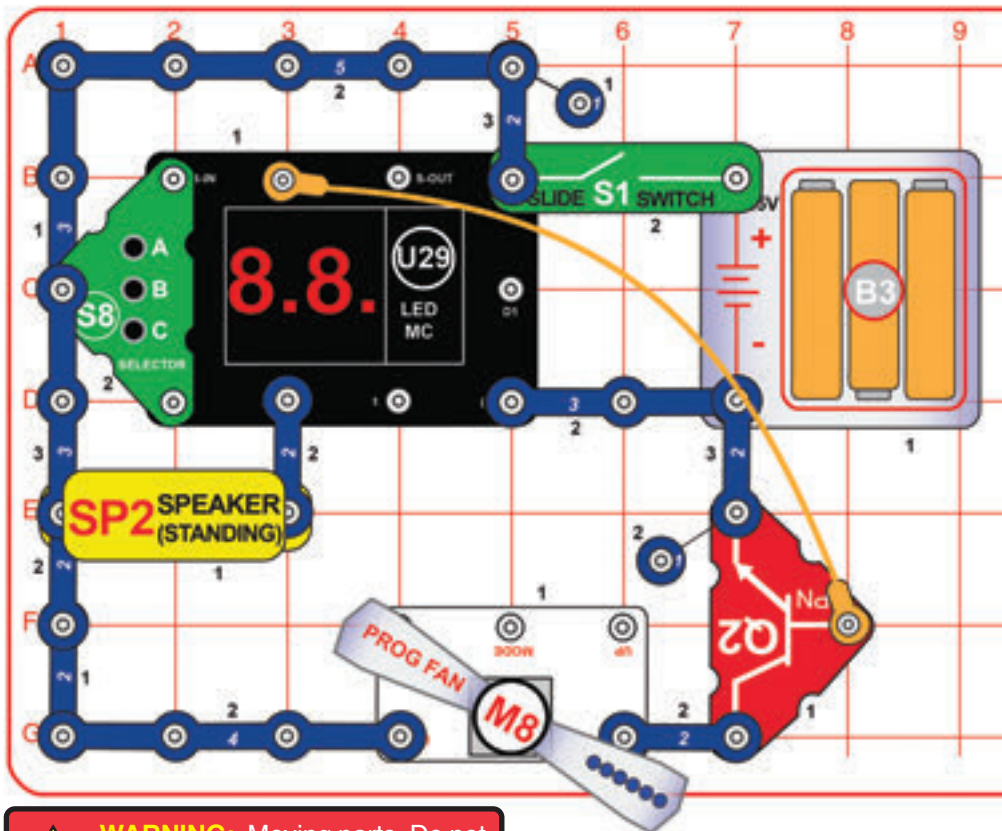

WARNING: Moving parts. Do not touch the fan while it is spinning.



This game is based on the card game "Blackjack". You can use project 15 to program a Blackjack-related phrase into the programmable fan (M8).

Twenty-One

Use this circuit and select Game 19 using the game selection procedure in project 17.

Once the player selects Game 19 and sees "Go" on the display, then:

- Press button C to get a first playing card (all jacks, queens, and kings are displayed as a 10). An Ace is displayed as an 11.
- The player then has the option to either:
 - ◆ Press A to Stand – a winning or losing song will then play depending on what the computer player gets:
 - ▶ If the computer player "busts" (i.e. goes over 21), then a winning song will play and the display will flash "Co" and then 22 indicating that the computer player went over 21. Then the game starts over by displaying a new card.
 - ▶ If the computer player has more points than the player, but not greater than 21, then a losing song will be played and the display will flash "Co" and the total points the computer player had. Then the game starts over by displaying a new card.
 - ▶ If the computer player has equal or less points than the player, then a winning song will be played and the display will flash "Co" and the total points the computer player had. Then the game starts over by displaying a new card.

OR

- ◆ Press C to Hit – Another card will be drawn and the value will be added to the previous card(s) value, and then:
 - ▶ If the player "busts" (i.e. goes over 21), then a losing song will play and the display will show the total value of all cards for a few seconds. Then the game starts over by displaying a new card.
 - ▶ If the total value of all player cards is still 21 or less, then the player must decide whether to Stand (press A) or take another Hit (press C again).
 - ▶ Note that Aces are treated as 11 points, unless the total value of the cards exceeds 21, in which case Aces are treated as 1 point. Sometimes you may see that your total reduced after you take a Hit, which means you had an Ace that was being treated as 11, but now is treated as a 1.



Project 39 Disco Twenty-One

In the preceding circuit you can replace the programmable fan (M8) with the disco motor (DM), as shown here.

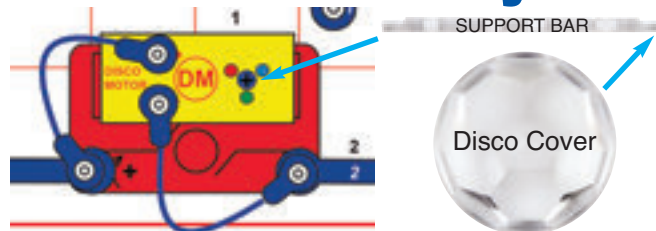



Project 40

Binary Coded Decimal

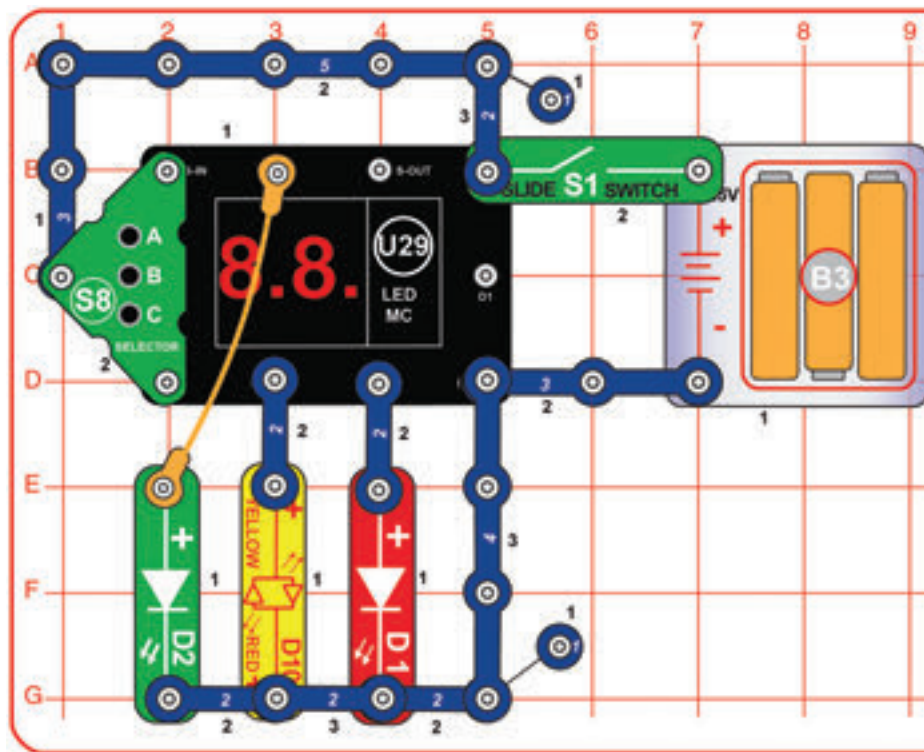

Use this circuit and select Game 20 using the game selection procedure in project 17.

Once the player selects Game 20 and sees “Go” on the display, then:

- Press button C and the LEDs will all go off and 0 will be on the U29 LED display.
- Continue to press button C and the 7-segment LED will increase by 1 each time you press button C, and the LEDs will go through a sequence as shown below. These sequences correspond to the binary coded decimal representation of the number in the first column.

Most computers store numbers in **binary**, which represents a number using only two states, typically 0 or 1 (because the simple electronic memory circuit actually storing it can only be on or off). Binary uses several 2-state numbers to represent a single number with more states, such as an octal number with 8 states or a decimal number with 10 states.

This circuit uses the U29 LED display to show an octal number with 8 states (0-7) and the same number in binary using 3 LEDs (red, yellow, & green).

U29 LED Display	Green LED	Yellow LED	Red LED
0	●	●	●
1	●	●	●
2	●	●	●
3	●	●	●
4	●	●	●
5	●	●	●
6	●	●	●
7	●	●	●

Project 41 Blink Rate Changer

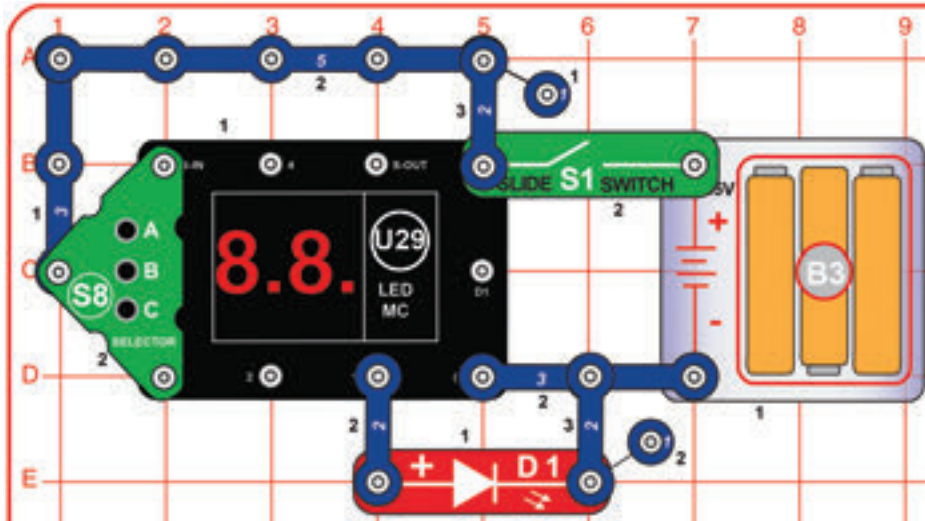

Turn on the slide switch (S1); the display on the LED-MC (U29) shows "00". Press the A button on the selector (S8) to increase the ones digit on the display, and press the C button on the selector to increase the tens digit on the display. When the display shows "21", press the B button on the selector to start.

The red LED (D1) will be blinking, and its blink rate will be changing.

Project 42 Click Rate Changer

Use the preceding circuit, but replace the red LED (D1) with the speaker (SP2). The circuit works the same way expect that it is clicks at different rates instead of flashing.

Project 43

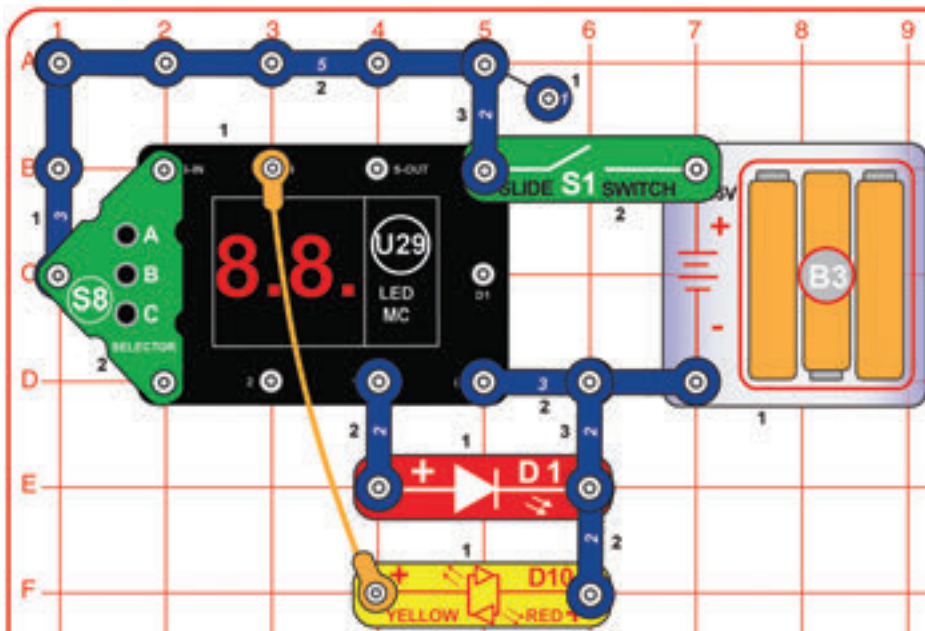

Double Changing Blinker

Modify the project 41 circuit to be this one. It works the same way, except there are two blinking LEDs.

The red & yellow LEDs (D1 & D10) are alternating, and are never on at the same time.



Project 44 Variable Disco Speed

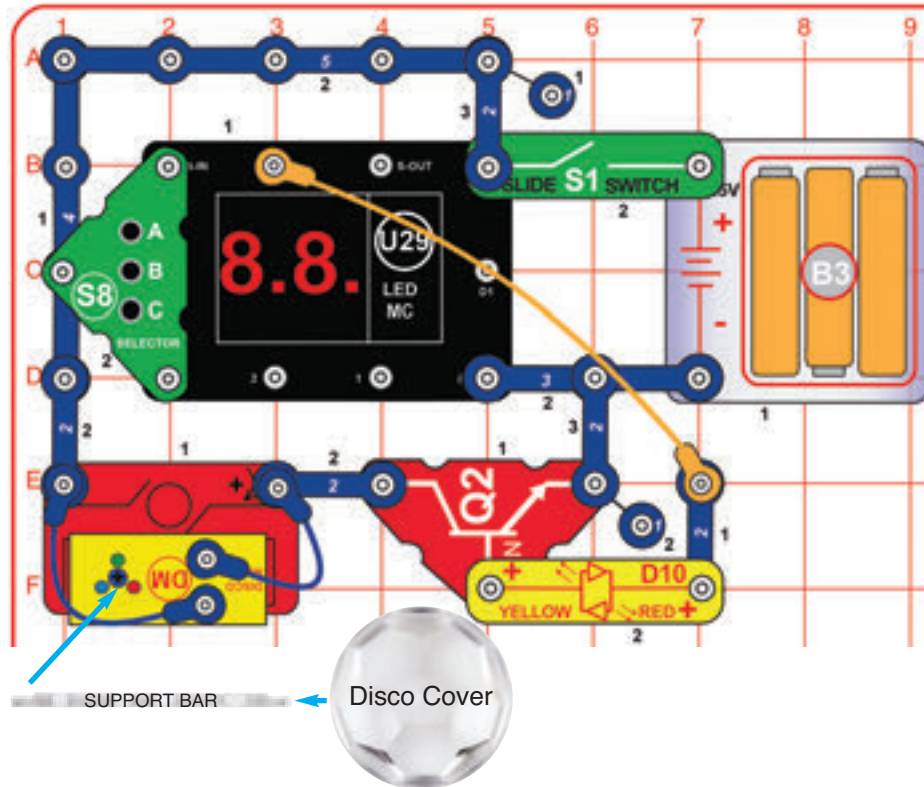

Turn on the slide switch (S1); the display on the LED-MC (U29) shows "00". Press the A button on the selector (S8) to increase the ones digit on the display, and press the C button on the selector to increase the tens digit on the display. When the display shows "21", press the B button on the selector to start.

The red/yellow LED (D10) will be blinking at varying speed, and the disco motor (DM) will be spinning at varying speed. For best effects, view in a dark room.

Project 45 Variable Disco Speed Variants

Use the preceding circuit, but reverse the red/yellow LED (D10), or replace it with the red LED (D1, "+" on right), green LED (D2, "+" on right), or the speaker (SP2).

Project 46 Loud Click Rate Changer

Use the project 44 circuit, but replace the disco motor (DM), including the blue jumper wires to it, with the speaker (SP2).

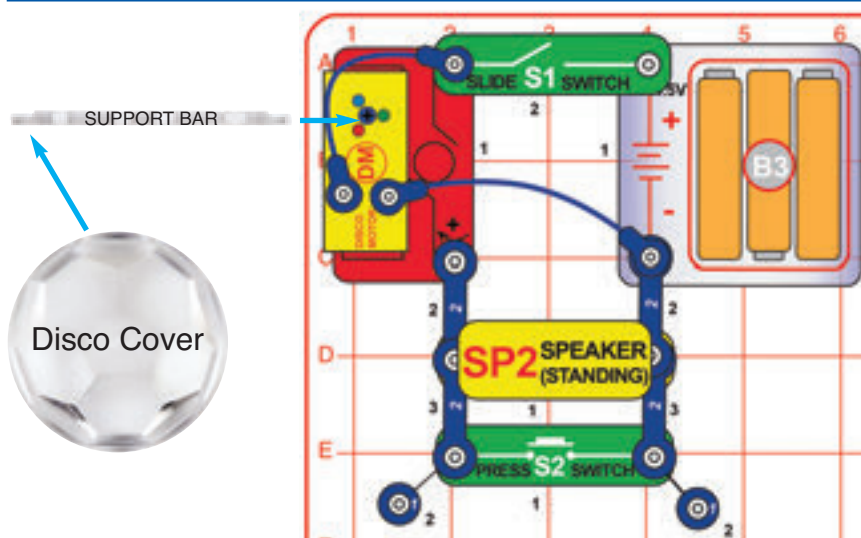

Project 47 Two Speed Disco Ball

Build the circuit as shown, place one of the disco covers on the disco motor (DM), and turn the slide switch (S1). The disco cover rotates as the LEDs in the disco motor light. You can change the speed by pushing the press switch (S2). The speaker (SP2) is used here as a resistor to limit the current and will not produce any sound.



Project 48

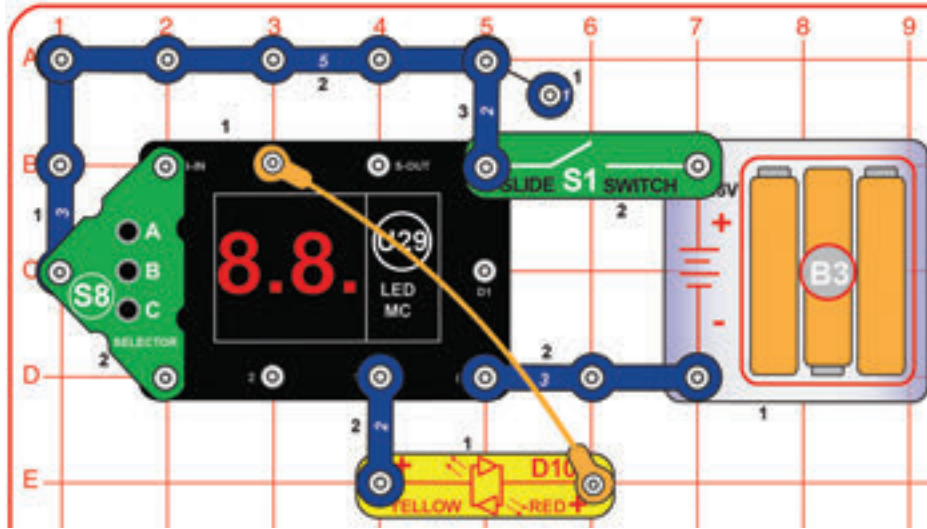

Bi-Color Light

Turn on the slide switch (S1); the display on the LED-MC (U29) shows "00". Press the A button on the selector (S8) to increase the ones digit on the display, and press the C button on the selector to increase the tens digit on the display. When the display shows "21", press the B button on the selector to start.

The red/yellow LED (D10) will be on continuously, but changing colors at varying speed.

The red/yellow LED (D10) is a bi-color LED, which means it has two LEDs (red & yellow) inside, connected in opposite directions. Notice that when D10 is changing colors quickly, its red and yellow colors tend to blend into orange.



Project 49

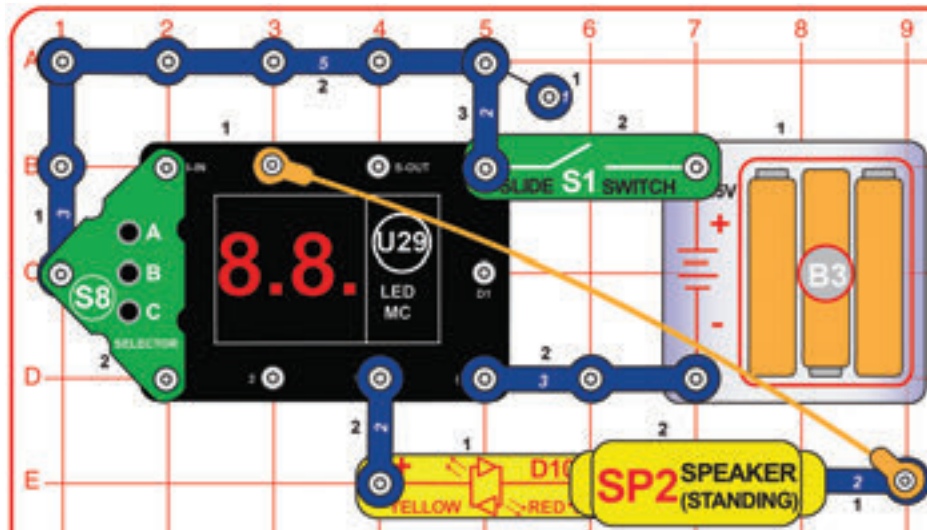

Bi-Color Light & Sound

Modify the preceding circuit to include the speaker (SP2), as shown. The circuit works the same way but now includes sound. The sound will not be very loud.



Project 50

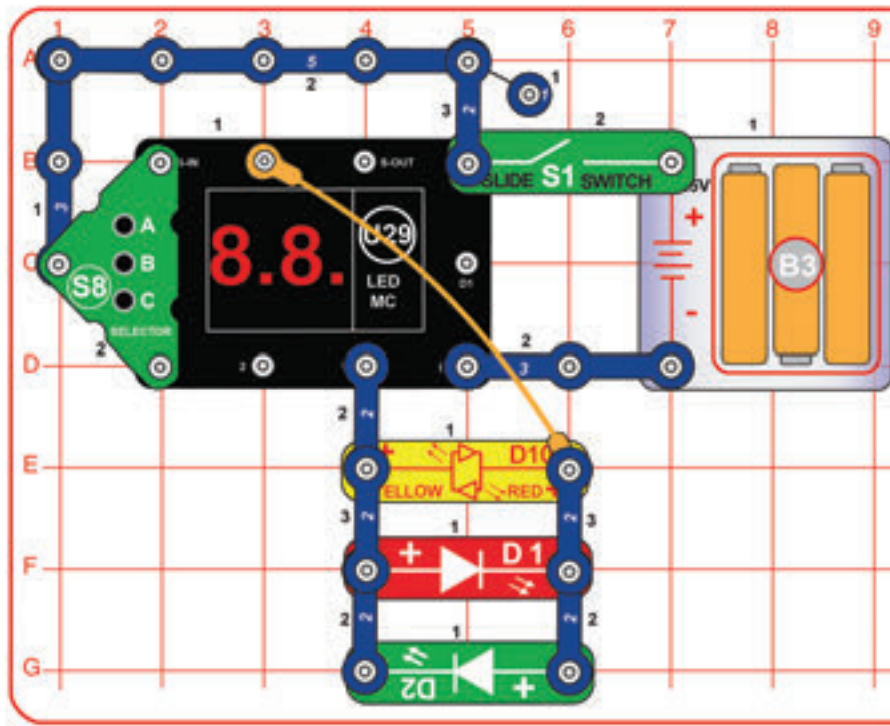

Dual Bi-Color Lights

Turn on the slide switch (S1); the display on the LED-MC (U29) shows "00". Press the A button on the selector (S8) to increase the ones digit on the display, and press the C button on the selector to increase the tens digit on the display. When the display shows "21", press the B button on the selector to start.

The red/yellow LED (D10) will be on continuously, but changing colors at varying speed. The red & green LEDs (D1 & D2) will be alternately between on and off, opposite each other, and synchronized with D10.



The red & green LEDs together act as a bi-color LED. Compare them to the red/yellow LED, which is a true bi-color LED.

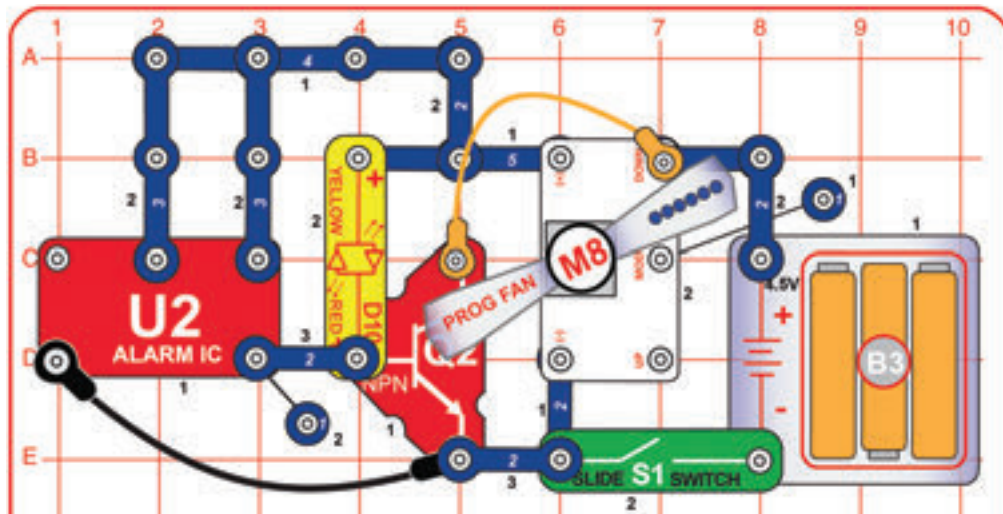

Project 51 Fast Phrase Changer

Turn on the slide switch (S1). The programmable fan (M8) spins, and changes the phrase displayed about once a second. See project 15 to change the phrases displayed.

This circuit uses the alarm IC (U2) to control the programmable fan (M8), cycling through the six phrases stored in it faster than normal.

WARNING: Moving parts. Do not touch the fan while it is spinning.





Project 52

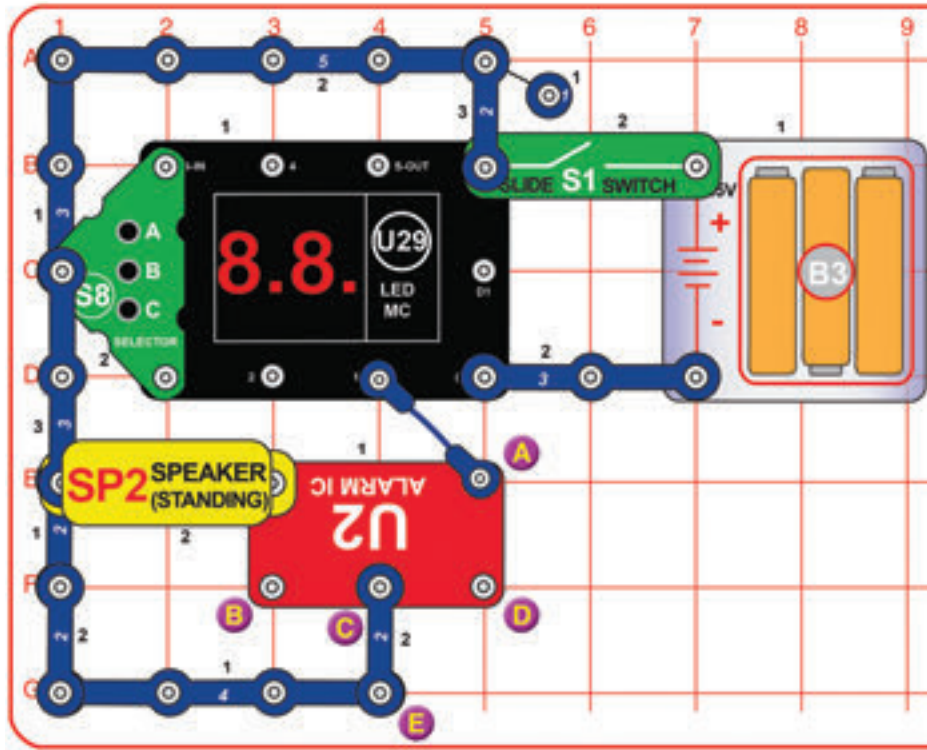

Funky Siren

Turn on the slide switch (S1); the display on the LED-MC (U29) shows "00". Press the A button on the selector (S8) to increase the ones digit on the display, and press the C button on the selector to increase the tens digit on the display. When the display shows "21", press the B button on the selector to start.

Strange sounds will be heard on the speaker (SP2).

The LED MC (U29) is turning on the alarm IC (U2) in short bursts, and varying their duration.

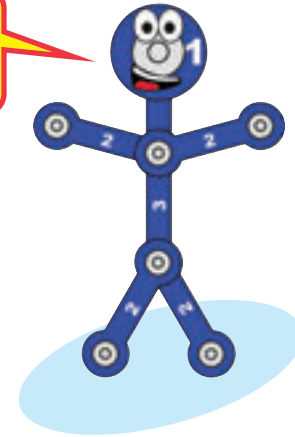

Project 53 Funky Siren (II)

Use the preceding circuit, but add a connection between the points marked B & C using a 1-snap and a 2-snap. The sound is different now.

Project 54 Funky Siren (III)

Use the preceding circuit, but remove the connection between B & C, and add a connection between C & D. The sound is different now.

Project 55 Funky Siren (IV)

Use the preceding circuit, but remove the connection between C & D, and add a connection between A & D. The sound is different now.

Project 56 Funky Siren (V)

Use the project 52 circuit, but remove the connection between C & E, and add a connection between D & E using a blue jumper wire. The sound is different now.



Project 57

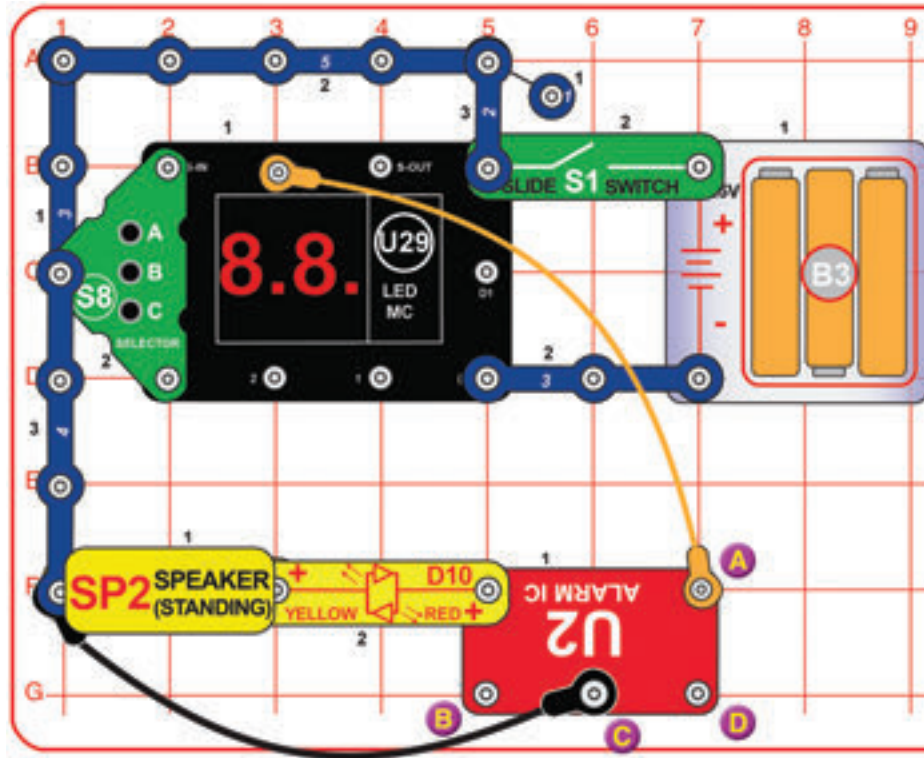

Funky Siren & Light

Turn on the slide switch (S1); the display on the LED-MC (U29) shows "00", and you hear a siren. Press the A button on the selector (S8) to increase the ones digit on the display, and press the C button on the selector to increase the tens digit on the display. When the display shows "21", press the B button on the selector to start. Strange sounds will be heard on the speaker (SP2), and the red LED (D1) changes in sync with the sound.

The sound is not as loud as in project 52, because the red LED is in series with the speaker, reducing the voltage to it.



Project 58 Funky Siren & Light (II)

Use the preceding circuit, but add a connection between the points marked B & C using a jumper wire. The sound is different now.

Project 59 Funky Siren & Light (III)

Use the preceding circuit, but remove the connection between B & C, and add a connection between C & D. The sound is different now.

Project 60 Funky Siren & Light (IV)

Use the preceding circuit, but remove the connection between C & D, and add a connection between A & D. The sound is different now.

Project 61 Funky Siren & Light (V)

Use the project 57 circuit, but connect the end of the black jumper wire to point D instead of point C. The sound is different now.



Project 62

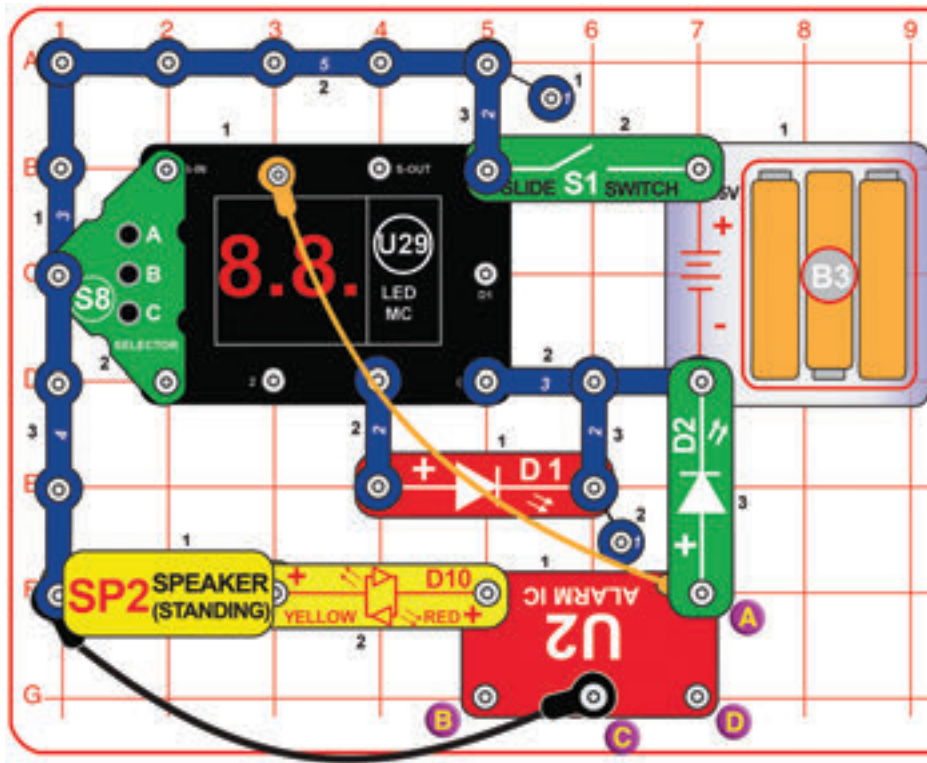

Tri-Light Funky Siren

Turn on the slide switch (S1); the display on the LED-MC (U29) shows "00". Press the A button on the selector (S8) to increase the ones digit on the display, and press the C button on the selector to increase the tens digit on the display. When the display shows "21", press the B button on the selector to start.

Strange sounds will be heard on the speaker (SP2), and three LEDs (D1, D2, & D10) change in sync with the sound.

Two of the LEDs are on or off at the same time, and the other one is opposite them - can you tell which?

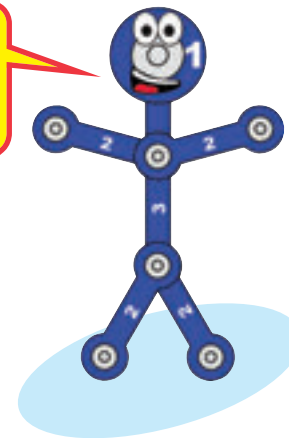

Project 63 Tri-Light Funky Siren (II)

Use the preceding circuit, but add a connection between the points marked B & C using a jumper wire. The sound is different now.

Project 64 Tri-Light Funky Siren (III)

Use the preceding circuit, but remove the connection between B & C, and add a connection between C & D. The sound is different now.

Project 65 Tri-Light Funky Siren (IV)

Use the preceding circuit, but remove the connection between C & D, and add a connection between A & D. The sound is different now.

Project 66 Tri-Light Funky Siren (V)

Use the project 62 circuit, but connect the end of the black jumper wire to point D instead of point C. The sound is different now.

Project 67 Hex-Light Funky Siren

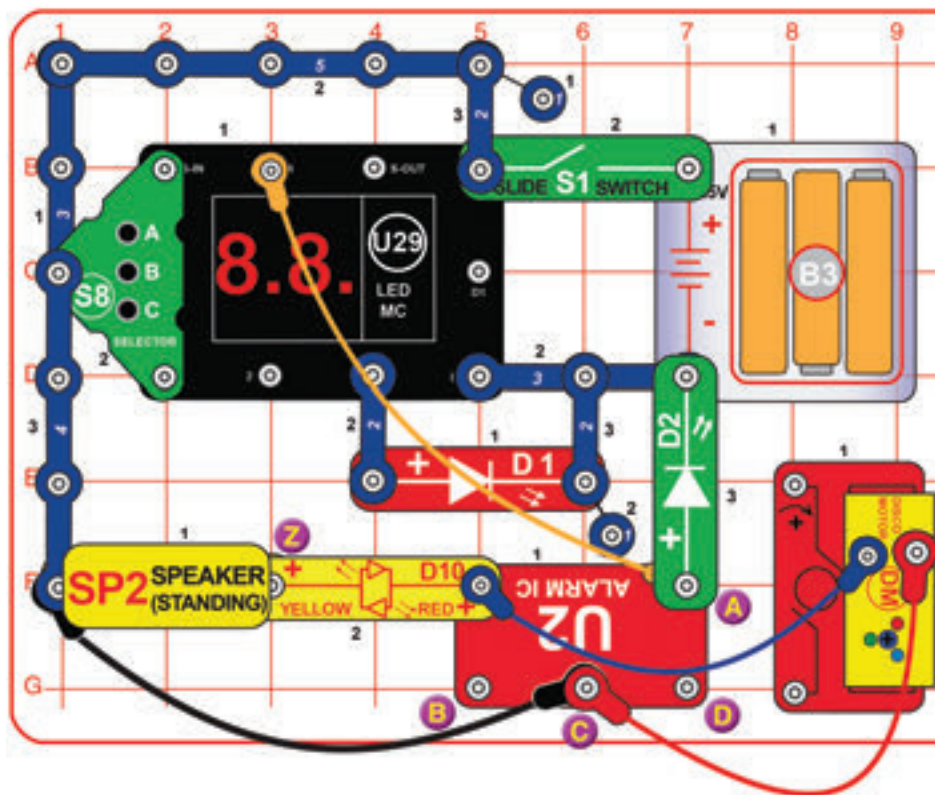

Turn on the slide switch (S1); the display on the LED-MC (U29) shows "00". Press the A button on the selector (S8) to increase the ones digit on the display, and press the C button on the selector to increase the tens digit on the display. When the display shows "21", press the B button on the selector to start.

Strange sounds will be heard on the speaker (SP2), and six LEDs (D1, D2, D10, and three in the disco motor (DM)) change in sync with the sound.

Project 68 Pent-Light Funky Siren

Use the preceding circuit, but move the end of the red jumper wire from point C to point Z (between the speaker and D10). The LEDs on the disco motor (DM) are dimmer now, and the blue LED may not be on at all.

In this circuit the LEDs in the disco motor get less voltage. This affects the blue LED the most, since it needs more voltage to function than red & green LEDs.

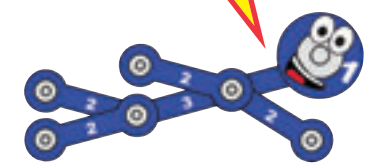

Project 69 Hex/Pent Light Funky Siren (II)

Use either of the preceding circuits, but add a connection between the points marked B & C using a blue jumper wire. The sound is different now.

Project 70 Hex/Pent Light Funky Siren (III)

Use the preceding circuit, but remove the connection between B & C, and add a connection between C & D. The sound is different now.

Project 71 Hex/Pent Light Funky Siren (IV)

Use the preceding circuit, but remove the connection between C & D, and add a connection between A & D. The sound is different now.

Project 72 Random Funky Siren & Lights

Use any of the five preceding circuits. Turn on the slide switch (S1); the display on the LED-MC (U29) shows "00". Press the A button on the selector (S8) twice to increase the ones digit on the display. When the display shows "02", press the B button on the selector to start.

There will be a random display of lights and a siren. The display on U29 also changes randomly.



Project 73

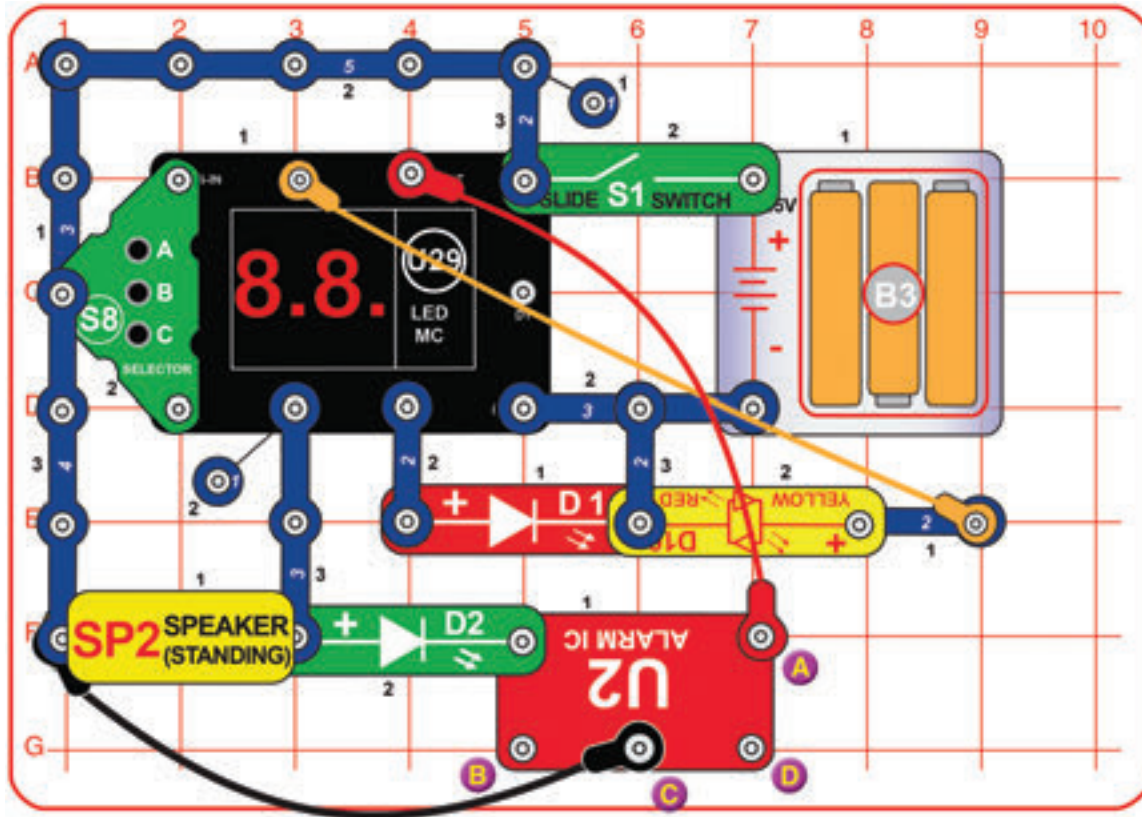

Siren Arcade

Turn on the slide switch (S1); the display on the LED-MC (U29) shows "00" and you hear a siren. Press the A button on the selector (S8) once to make the display show "01", then press the B button on the selector to start.

Every few seconds one or more of the following will happen, randomly changing: the red LED (D1) lights, the yellow LED (D10) lights, the speaker plays a tune, the speaker plays a siren, the green LED (D2) lights, and the U29 LED display shows a random pattern.



Project 74 Siren Arcade (II)

Use the preceding circuit (no need to reset the LED-MC), but add a connection between the points marked B & C using a blue jumper wire. The sound is different now.

Project 75 Siren Arcade (III)

Use the preceding circuit, but remove the connection between B & C, and add a connection between C & D. The sound is different now.

Project 76 Siren Arcade (IV)

Use the preceding circuit, but remove the connection between C & D, and add a connection between A & D. The sound is different now.

Project 77 Siren Arcade (V)

Use the project 73 circuit, but connect the end of the black jumper wire to point D instead of point C. The sound is different now.



Project 78 Fast Siren Arcade

Use any of the five preceding circuits, but turn off the slide switch (S1) to reset the LED-MC (U29). Turn on the slide switch; the display on the LED-MC shows "00". Press the A button on the selector (S8) two or three times to increase the ones digit on the display. When the display shows "02" or "03", press the B button on the selector to start.

The circuit works the same, except that it changes faster ("03" is faster than "02").

Project 84 Slow-Fast Disco

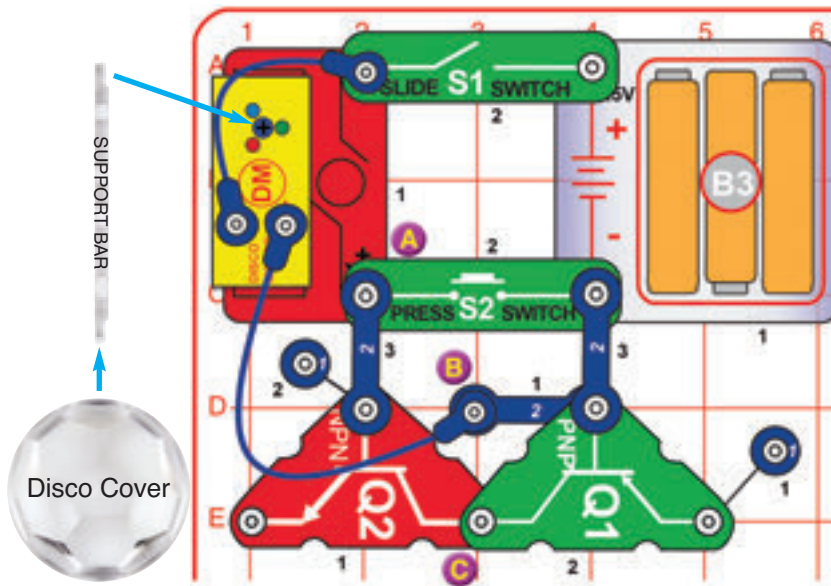

Place one of the disco covers onto the disco motor (DM). Turn on the slide switch (S1). The disco cover spins and lights project onto the ceiling. Push the press switch (S2) to speed up the disco cover. You can also tilt the circuit so the lights shine on a wall. The effects are best viewed in a dark room.

Are the patterns more impressive when the disco cover is spinning slower or faster?

When connected as shown in this circuit, the Q1 & Q2 transistors act as a "speed bump" to reduce the voltage to the disco motor a little, slowing it down. Pressing S2 bypasses this speed bump so the disco motor spins at full speed.



Project 85 Not So Slow-Fast Disco

Add a 2-snap wire across points B & C, on level 3. Now it is a little faster when S2 is not pressed.

This change bypasses Q1, so there is less voltage drop and a smaller "speed bump".

Project 86 Dimmer Disco

Use either of the two preceding circuits but move the end of the blue jumper wire from point B to point A. Now the lights are dimmer.

In the preceding two projects, the LEDs on top of the disco motor were always connected to the full battery voltage, keeping them brightest. This circuit connects them to the "speed bump", reducing the voltage to them and making them dimmer. The blue light is affected the most by this change.

Project 87 Super-Slow Disco

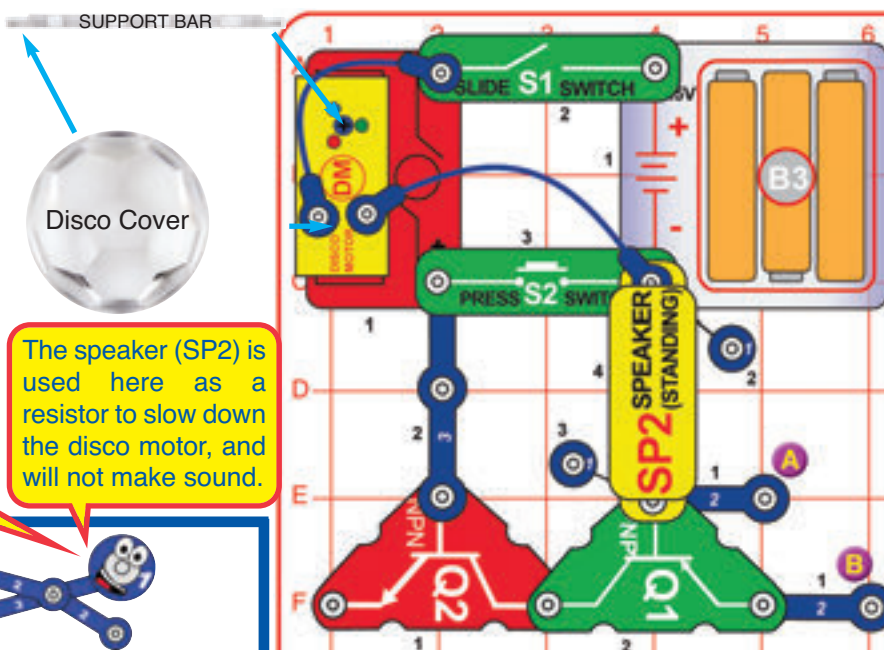

The speaker (SP2) is used here as a resistor to slow down the disco motor, and will not make sound.

Place one of the disco covers onto the disco motor (DM) and turn on the slide switch (S1). The LEDs in the disco motor are on, but the disco cover won't move. Push the press switch (S2) and the disco cover spins, and keeps spinning after you release S2. The light patterns are best in a dark room.

Compare the patterns when the disco is spinning fast (with S2 pressed) and slow (S2 released). Try both disco covers, and try holding the circuit at an angle near a wall.

If the motor does not continue spinning after you released S2, then replace your batteries, or place the orange jumper wire across points A & B.

Project 88 Slow-Fast Word Fan

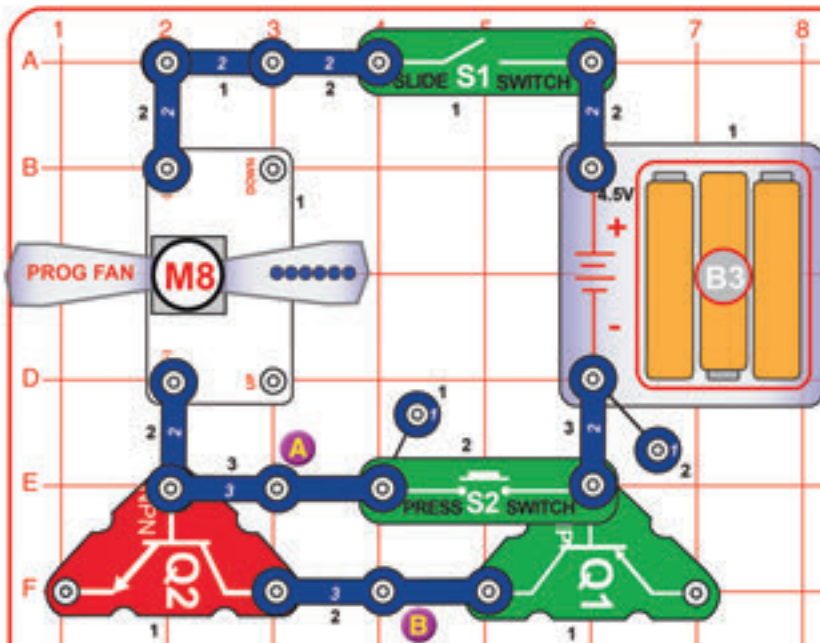

Turn on the slide switch (S1). The programmable fan (M8) spins and may slowly display messages. Push the press switch (S2) to speed up the fan and slowly display messages.

WARNING: Moving parts. Do not touch the fan while it is spinning.

When connected as shown in this circuit, the Q1 & Q2 transistors act as a "speed bump" to reduce the voltage to the programmable fan, slowing it down and making the messages it can display dim or off. Pressing S2 bypasses this speed bump so the fan spins at full speed and its message circuit can operate properly.

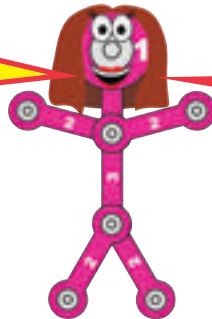

Project 89 Not So Slow-Fast Word Fan

Add a blue jumper wire across points A & B. Now it is a little faster when S2 is not pressed, and messages on it are brighter.

This change bypasses Q2, so there is less voltage drop and a smaller "speed bump".

Project 90 Slow-Fast Fan

Use either of the two preceding circuits, but reverse the connection to the programmable fan (M8). The fan still spins, but it does not display any messages.

Project 91 Different Sounds

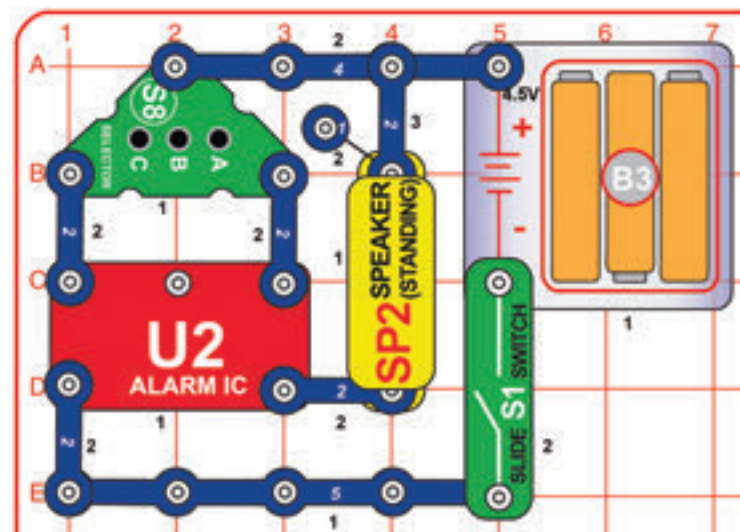

Build the circuit as shown and turn the slide switch (S1) on. Press the A, B, and C buttons on the selector (S8) to make different sounds.

Project 92 Selector

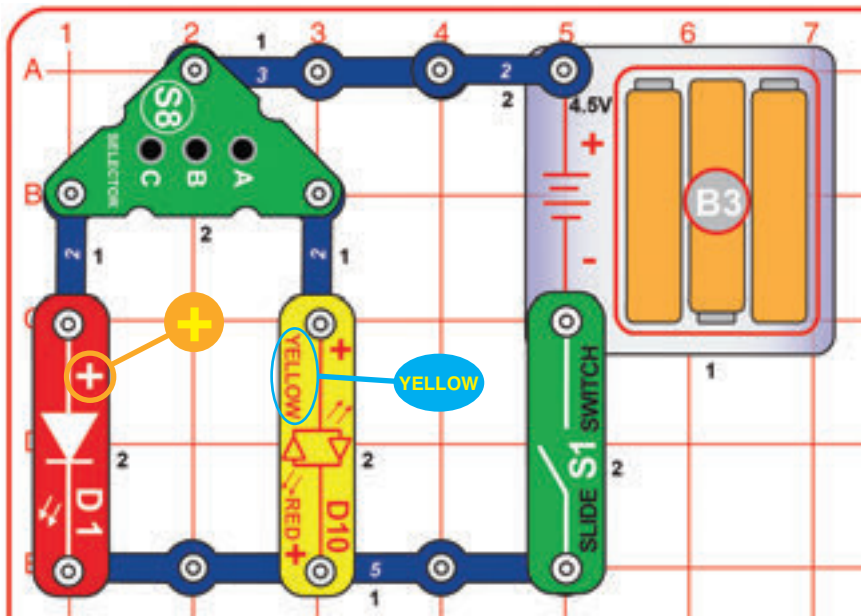

Turn on the slide switch (S1). Press button C on the selector (S8) to light the red LED (D1), press button A on the selector to light the yellow LED (D10), or press button B on the selector to light both LEDs.

Project 93 Red or Red

Use the preceding circuit, but reverse the orientation of the yellow bi-color LED (D10), to make it red.

Project 94 Green Selector

Use the project 92 circuit, but replace either of the LEDs (D1 or D10) with the green LED (D2).

Project 95 Triple Select

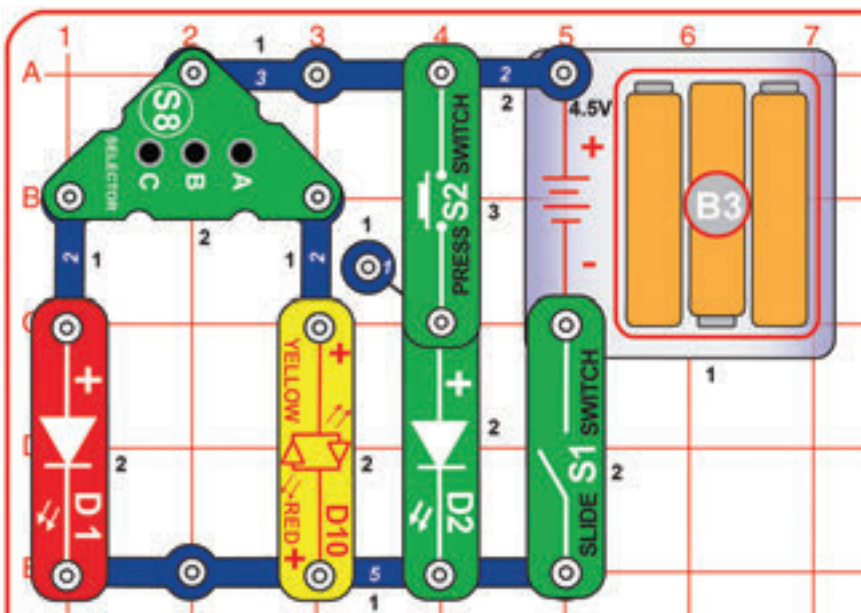

Use the project 92 circuit, but add the green LED (D2) and press switch (S2) as shown. Press buttons on S2 and S8 to light the LEDs.

Project 96 Red/Yellow Selector

Use the preceding circuit, but re-arrange the LEDs, so that the red & yellow ones get a turn with the S2 switch.

The buttons in the selector (S8) have more electrical resistance than the button in the press switch (S2), so the LEDs controlled by S8 may not be as bright as the one controlled by S2.



Project 97 Toggle 00

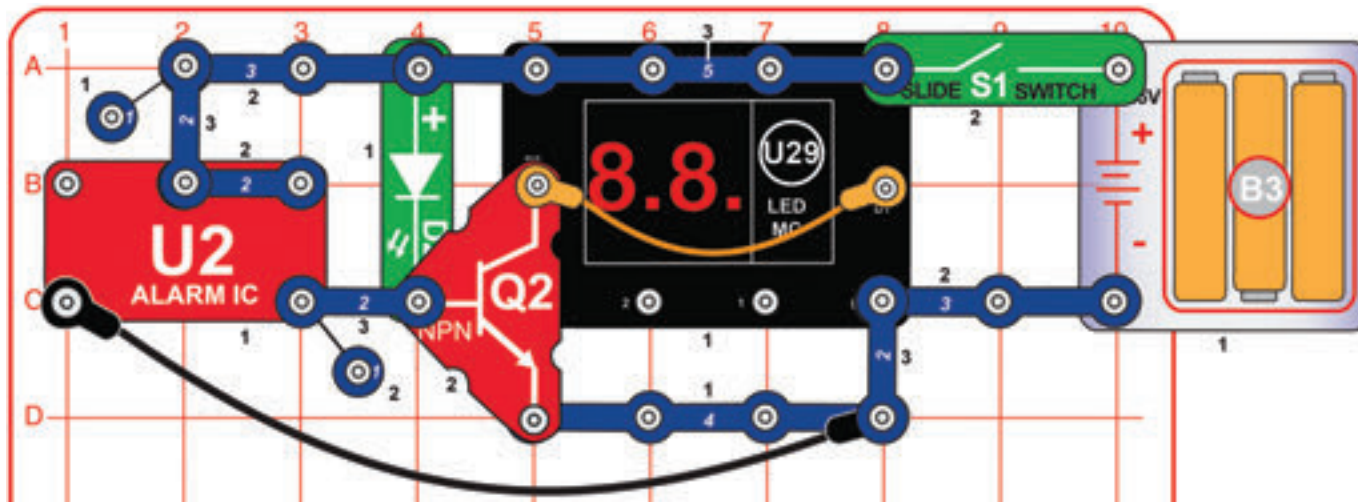

Turn on the slide switch (S1). The LED display on the LED-MC (U29) toggles between on and off.

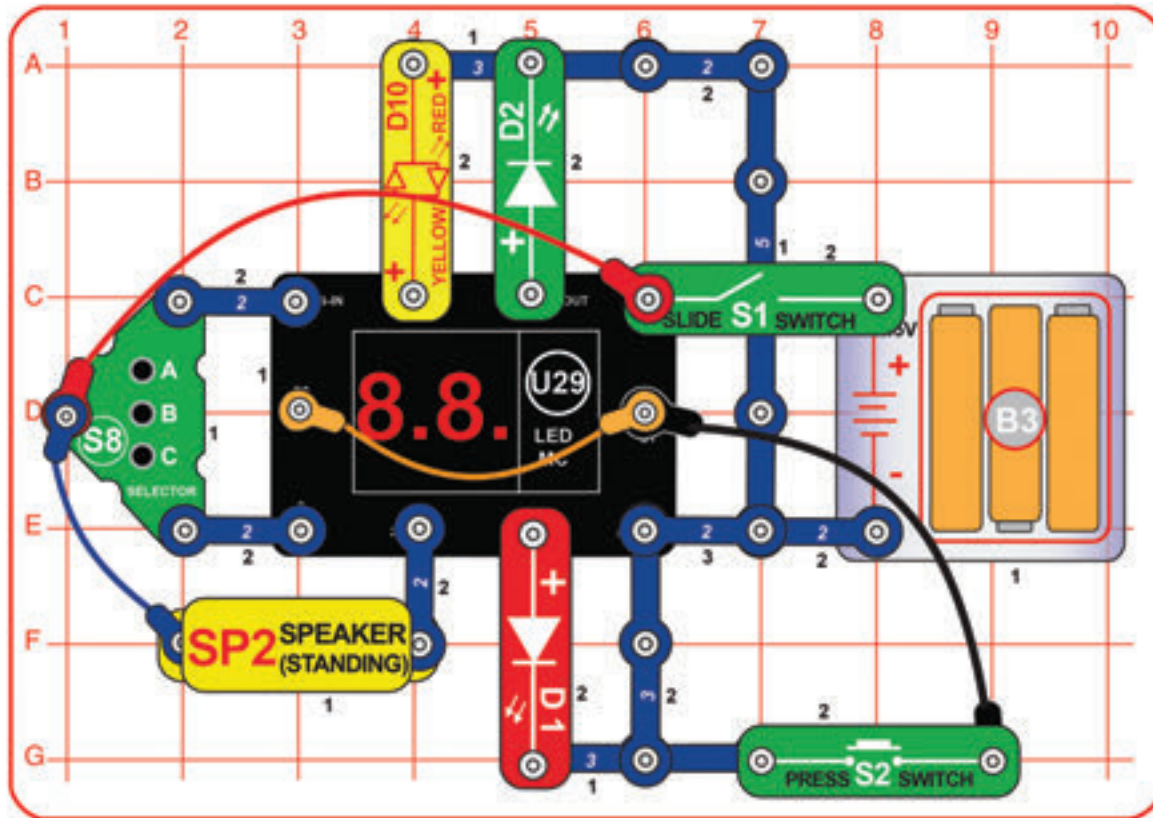

Project 98 LED-MC Test

Turn on the slide switch (S1); the display on the LED MC (U29) should show "00". Select game 1 by pressing the A button on the selector (S8), then the B button.

Every 2 seconds one or more of the following will happen, randomly changing: D1 lights, D2 lights, D10 lights, SP2 plays a tune, the U29 LEDs display a random pattern. Make sure that eventually all these parts are being controlled. If not, something is wrong. Also, pushing the press switch (S2) should turn off the LED display on U29 until you release S2.

If desired, you can speed things up by turning S1 off and on (to reset the circuit), then selecting game 2 or game 3 by pressing the A button on S8, then the B button. The tunes played on the speaker (SP2) will play at the same speed as before.



Project 99 Green Light

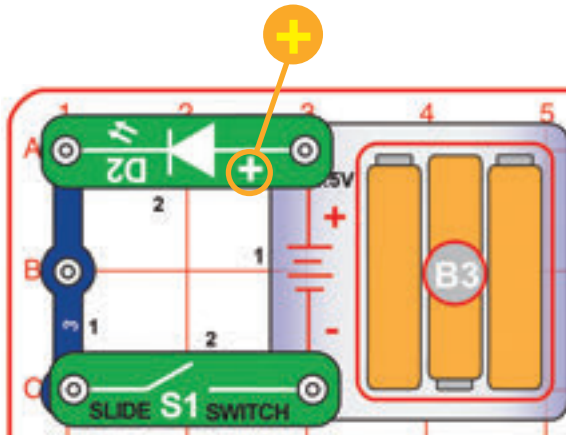

Turn on the slide switch (S1), and the green LED (D2) lights.



Project 100 Red/Yellow Light

Replace the green LED (D2) with the red/yellow bicolor LED (D10); try it in both directions (red on right, and yellow on right).

LEDs are light emitting diodes, which convert electrical energy into light. The color of the light depends on the characteristics of the material used in them. The red/yellow bicolor LED is actually a red LED and a yellow LED connected in opposite directions inside the same part.

LEDs are much more energy-efficient than incandescent light bulbs, and can be made very small.

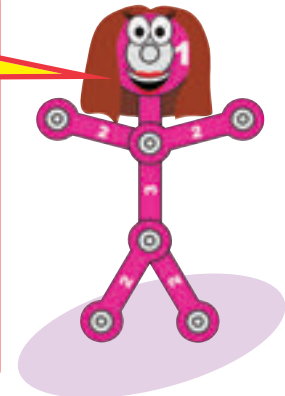

Project 101

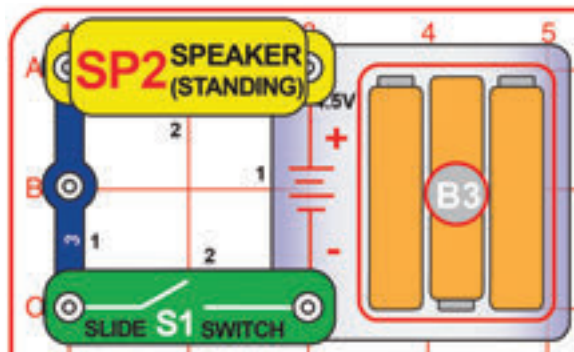

Turn the slide switch (S1) on and off several times. You hear static from the speaker (SP2) when you turn the switch on or off.

The speaker uses electromagnetism to create changes in air pressure, which your ears feel and interpret as sound. Think of the speaker as creating pressure waves in the air just like waves in a pool. You only see waves in the pool when you disturb the water, so the speaker only makes sound when the voltage changes.

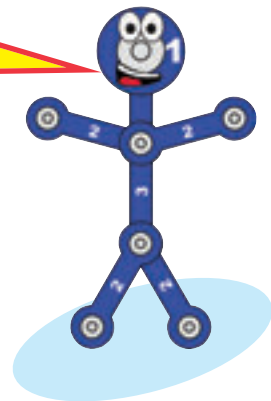



Project 110

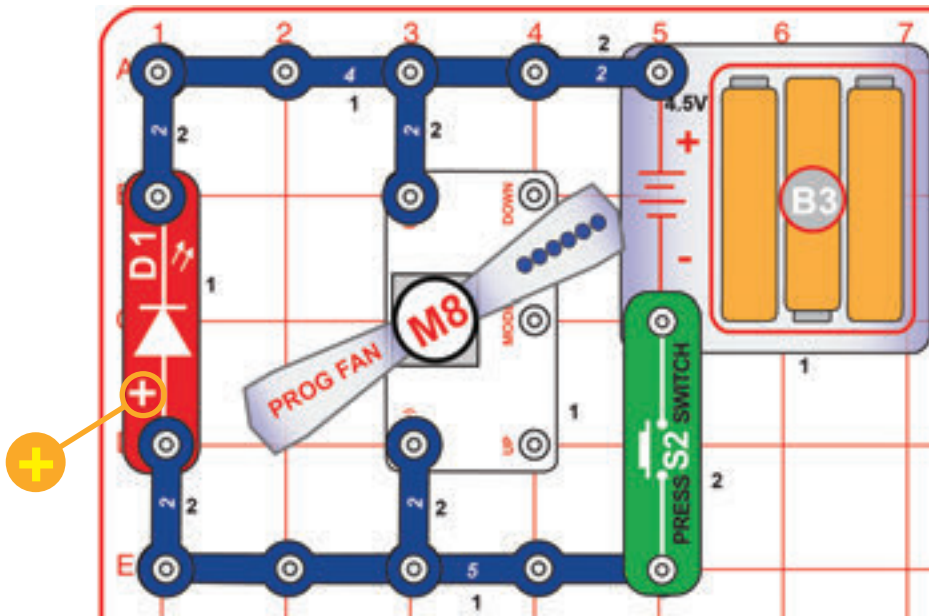

Fan Flash Energy

Hold down the press switch (S2) for a few seconds and then watch the red LED (D1) as you release the switch. The LED flashes briefly but only after the batteries (B3) are disconnected from the circuit. This effect is much easier to see in a dimly lit room.

Do you know why the red LED flashes? It flashes because the motor in the programmable fan (M8) uses a magnetic field to spin the shaft. When the switch is released this energy creates a brief current through the LED.

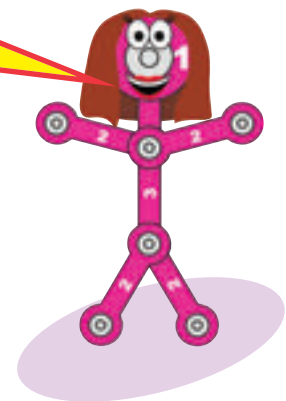

! WARNING: Moving parts. Do not touch the fan while it is spinning.



Project 111

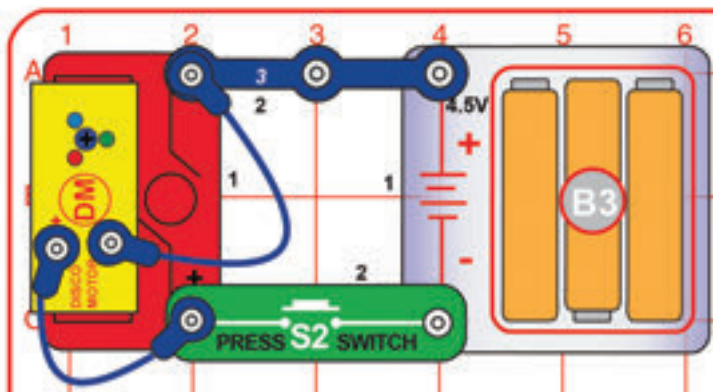

Motor Flash Energy

Hold down the press switch (S2) for a few seconds and then watch the LEDs on the disco motor (DM) as you release the switch. The LEDs flash briefly but only after the batteries (B3) are disconnected from the circuit. This effect is much easier to see in a dimly lit room.

Do you know why the LEDs flash? They flash because the motor in the disco motor (DM) uses a magnetic field to spin the shaft. When the switch is released this energy creates a brief current through the LEDs.

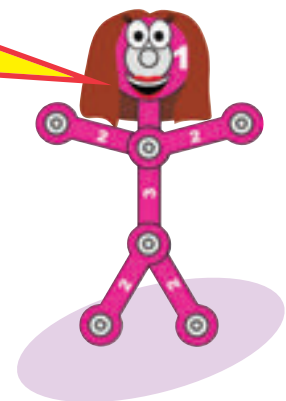



Project 112

Tri-Light Machine Gun

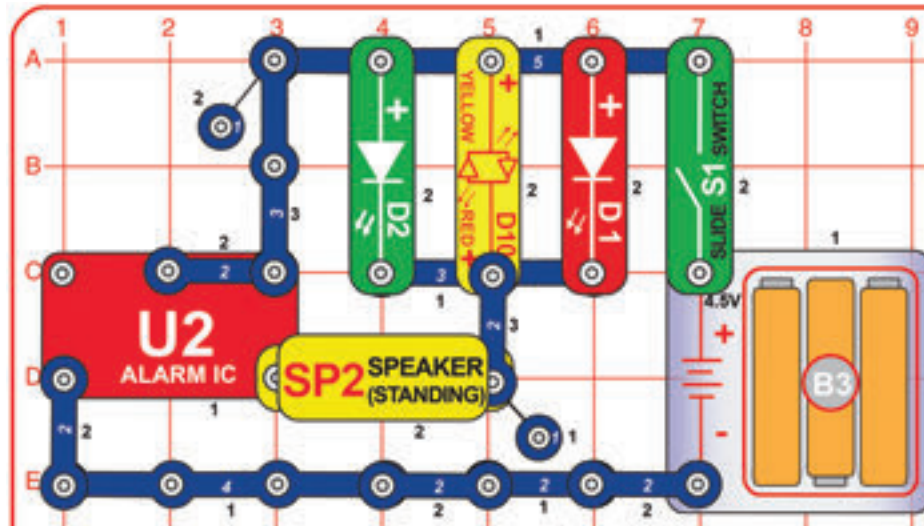

Turn on the slide switch (S1). Three LEDs are flashing and you hear a machine gun sound.

The lower-right snap of the alarm IC is like an electrical gate, opening and closing quickly to let small bursts of electric current flow in. The bursts of electric current also flow through the green, yellow, & red LEDs (lighting them) and the speaker (which produces sound). The alarm IC produces the different siren sounds by adjusting the pattern of current bursts through the speaker.

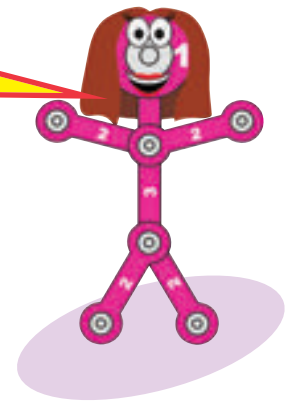

Project 113

Hex-Light Machine Gun

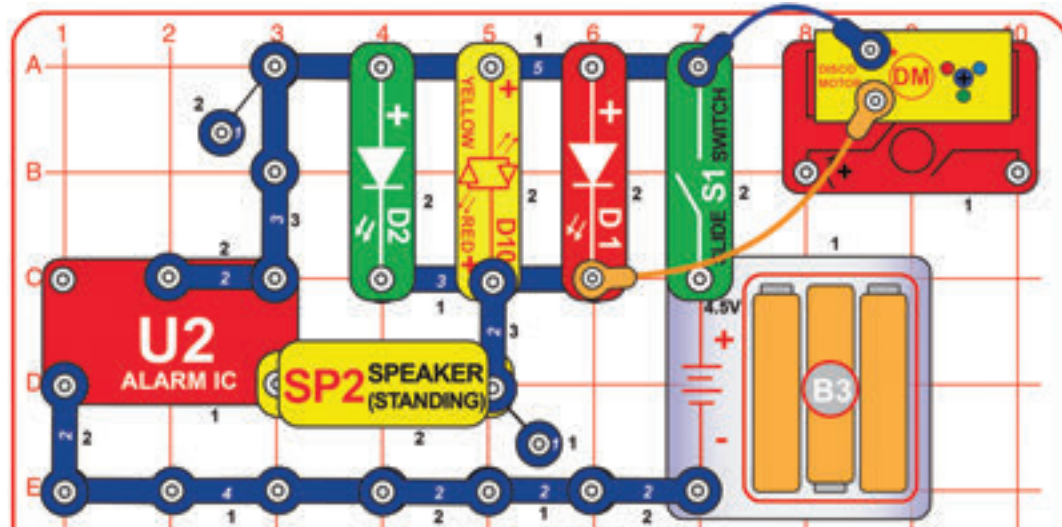

Turn on the slide switch (S1). Six LEDs (including three in the disco motor (DM)) are flashing and you hear a machine gun sound.
The blue LED in the disco motor may be dim.



Project 114

Trip-Wire Alarm

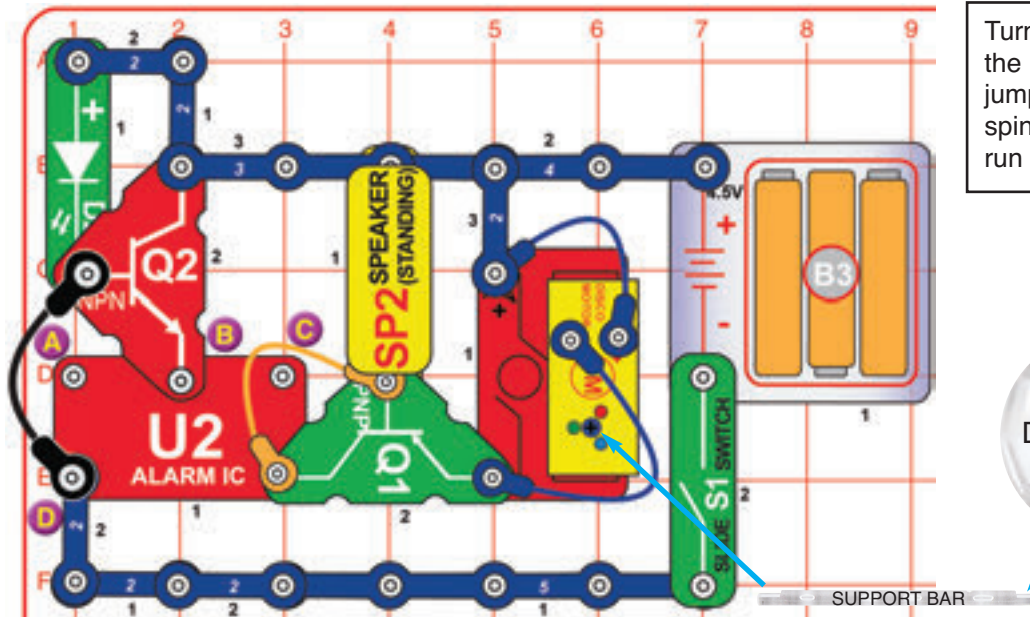

Turn on the slide switch (S1). The green LED (D2) comes on (indicating the circuit is ready), but otherwise nothing happens. Break the black jumper wire connection and an alarm sounds, lights shine, and things spin. You could replace the black jumper wire with a longer wire and run it across a doorway to signal an alarm when someone enters.

The siren sounds in this project may seem distorted compared to other projects. This is because electrical noise generated by the motor in the disco motor (DM) disrupts the alarm IC (U2). Compare this circuit to following one.

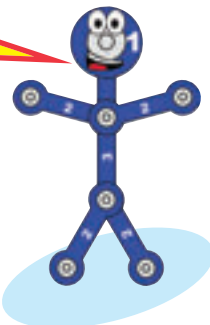

Project 115

Trip-Wire Alarm with Better Sound

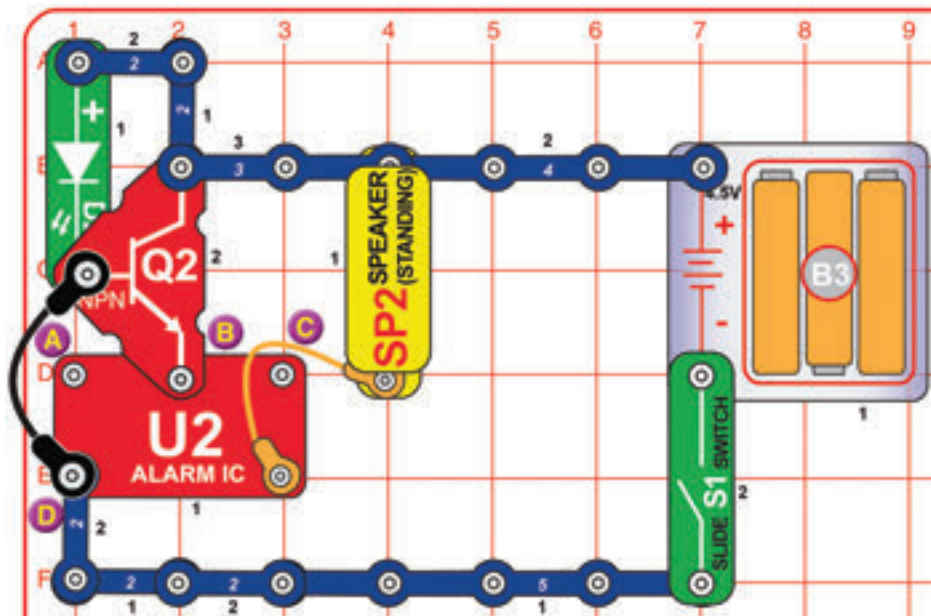

This circuit is like the preceding one, except with better sound and without the disco motor (DM). Turn on the slide switch (S1). The green LED (D2) comes on (indicating the circuit is ready), but otherwise nothing happens. Break the black jumper wire connection and an alarm sounds. You could replace the black jumper wire with a longer wire and run it across a doorway to signal an alarm when someone enters.

Project 116 Trip-Wire Machine Gun

Use either of the preceding circuits, but connect the red jumper wire between the points marked B & C. Now it sounds like a machine gun.

Project 118 Trip-Wire European Siren

Use either of the preceding circuits, but connect the red jumper wire between the points marked A & D. Now it sounds like a European siren.

Project 117 Trip-Wire Fire Engine

Use either of the preceding circuits, but connect the red jumper wire between the points marked A & B. Now it sounds like a fire engine.



Project 119

Water Alarm

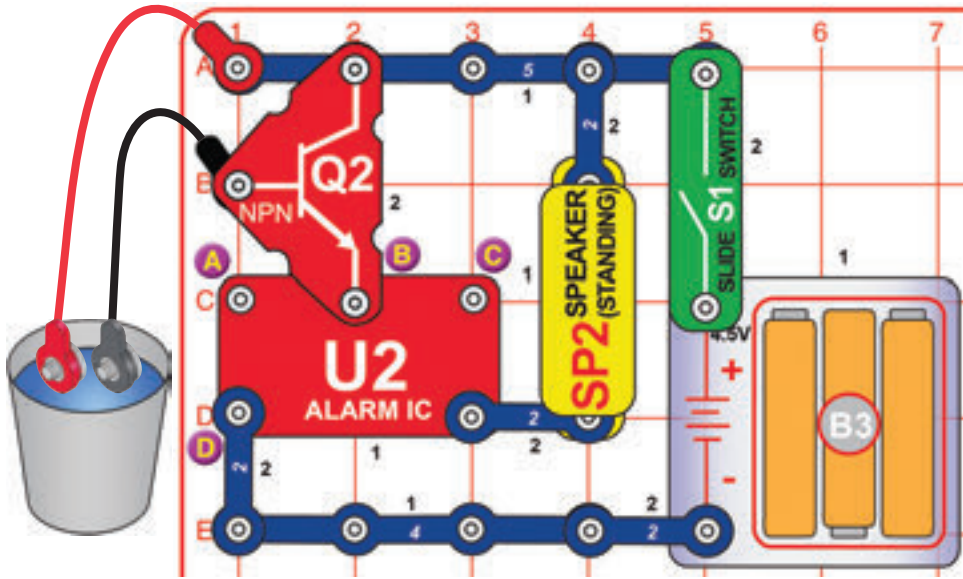

Build the circuit shown, but initially leave the red & black jumper wires outside the cup. Turn on the slide switch (S1); nothing happens. Place the jumper wires into a cup of water and an alarm sounds!

Variants:

1. Change the sound by using a 1-snap wire and a 2-snap wire to make a connection across points A & B, or A & D, or B & C.
2. Remove the NPN transistor (Q2) and instead connect the black jumper wire at point B.

Don't drink any water used here.

Water has some electrical resistance, but much less than air. The NPN transistor acts as an amplifier, to help overcome water's resistance. You could use longer wires and lay them on your basement floor, if your basement floods during a storm, then this circuit will sound an alarm!

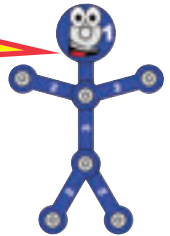

Project 120 Human Alarm

Use the preceding circuit, but instead of putting the red & black jumper wires in the water, touch the metal ends of them with your fingers. You may have to hold them tightly or wet your fingers to make this work.

Your body is mostly water, so it also has some electrical resistance, but much less than air.

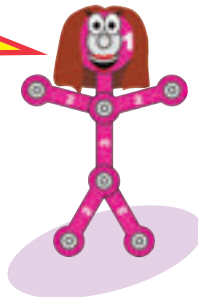

Project 121 Draw an Alarm

Use the circuit from project 119, but omit the cup of water and leave the loose ends of the jumpers unconnected for now. There is one more part you need and you are going to draw it. Take a pencil (No. 2 lead is best but other types will also work). **SHARPEN IT**, and fill in the shape below. You will get better results if you place a **hard**, flat surface directly beneath this page while you are drawing. Press **hard** (but don't rip the paper), and fill in the shape **several times** to be sure you have a **thick, even layer** of pencil lead.



Press the metal ends of the jumper wires on the shape and move them around over the drawing. If you don't hear any sound then move the ends closer together and move over the drawing, add another layer of pencil lead, or put a drop of water on the jumper ends to get better contact with your fingers.

The black core of pencils is graphite, the same material used in resistors (electronic components that limit and control the flow of electricity).



Project 122 Water- Human-Drawn Machine Gun

Use any of the projects 119-121 circuits, but add a connection between the points marked B & C using a 1-snap and a 2-snap. Now it sounds like a machine gun.

Project 123 Water-Human- Drawn Fire Engine

Use any of the projects 119-121 circuits, but remove the connection between B & C, and add a connection between A & B. Now it sounds like a fire engine.

Project 124 Water-Human- Drawn European Siren

Use any of the projects 119-121 circuits, but remove the connection between A & B, and add a connection between A & D. Now it sounds like a European siren.

Project 125 Yellow & More

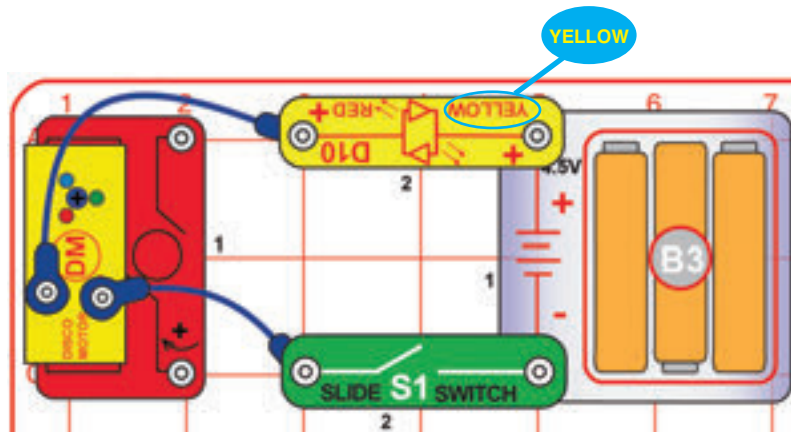

Turn on the slide switch (S1). The yellow LED (D10) and some LEDs on the disco motor (DM) light. The disco motor shaft will not spin.

Electric current flows from the batteries, through the yellow LED, divides among the LEDs on the disco motor, then flows through the slide switch and back to the batteries.

On the disco motor, the red LED is brightest because it needs less voltage to turn on than the green & blue LEDs. The blue LED is dimmest (or off) because it needs more voltage to turn on than red or green.



Project 126 Red & More

Use the preceding circuit, but reverse the yellow LED (D10) or replace it with the red LED (D1), "+" on the right.

Project 127 Green & More

Use the project 125 circuit, but replace the yellow LED (D10) with the green LED (D2), "+" is on the right.

The green LED (D2) takes more voltage to turn on than yellow or red, leaving less voltage for the LEDs on the disco motor, making them dimmer.



Project 128

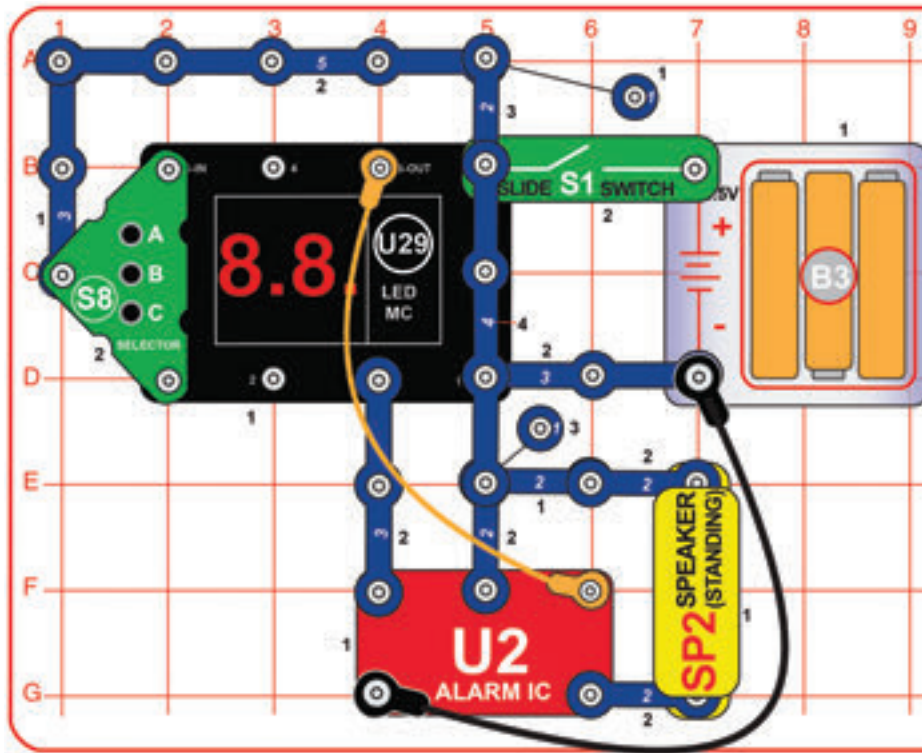

Random Siren Selector

Turn on the slide switch (S1); the display on the LED-MC (U29) shows "00". Press the A button on the selector (S8) once to make the display show "01", then press the B button on the selector to start.

Every few seconds the speaker (SP2) randomly plays one of three siren sounds, and the U29 LED display shows a random pattern.



Project 129 Fast Random Siren Selector

Use the preceding circuit. Turn on the slide switch (S1); the display on the LED-MC (U29) shows "00". Press the A button on the selector (S8) two or three times to increase the ones digit on the display. When the display shows "02" or "03", press the B button on the selector to start.

The circuit works the same, except that it changes faster. "03" is faster than "02".



Project 130 LED Random Siren Selector

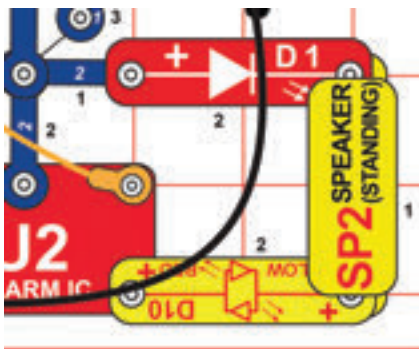

Modify the project 128 circuit by adding the red & red/yellow LEDs (D1 & D10) as shown. It works the same way, but has more lights and the sound is not as loud.



Project 131 5-LED Random Siren Selector

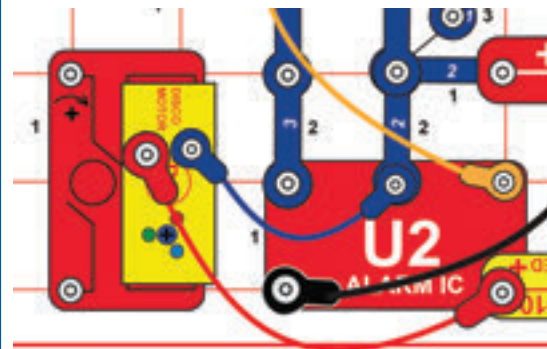

Modify the preceding circuit by adding the LEDs in the disco motor (DM) using blue & red jumper wires as shown. It works the same way, but has more lights.



Project 132 Disco Arcade Show

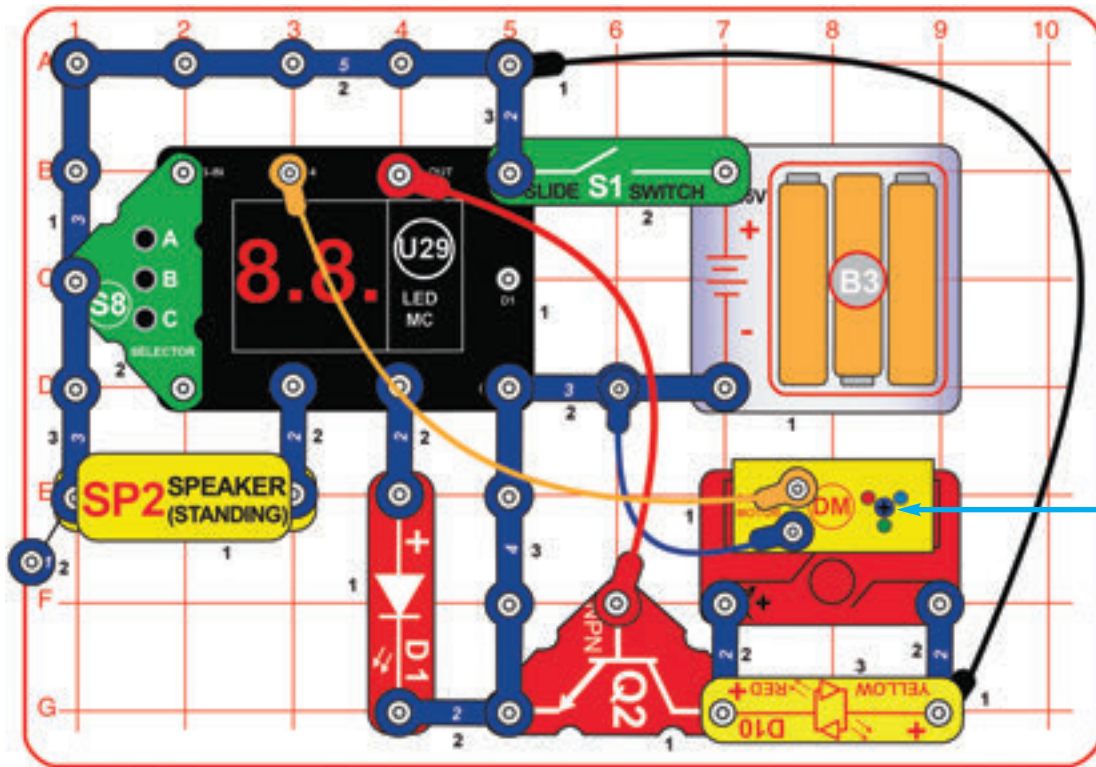

Turn on the slide switch (S1); the display on the LED-MC (U29) shows "00". Press the A button on the selector (S8) once to make the display show "01", then press the B button on the selector to start.

Every few seconds one or more of the following will happen, randomly changing: the red LED (D1) lights, the disco cover spins, the lights on the disco motor (DM) light, the speaker plays a tune, and the U29 LED display shows a random pattern.

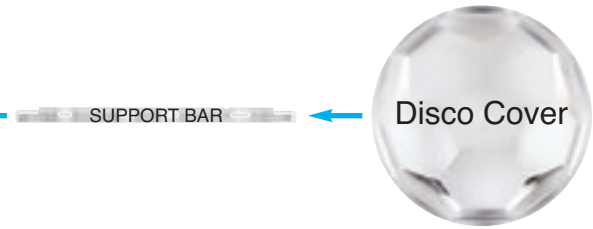

Alternate connections for speaker (a little louder):

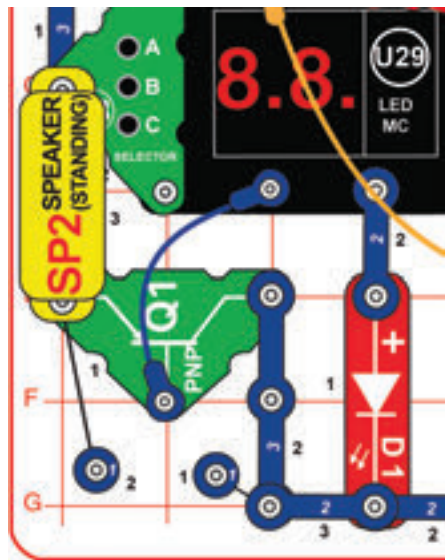

Project 133 Fast Disco Arcade Show

Use the preceding circuit. Turn on the slide switch (S1); the display on the LED-MC (U29) shows "00". Press the A button on the selector (S8) two or three times to increase the ones digit on the display. When the display shows "02" or "03", press the B button on the selector to start.

The circuit works the same, except that it changes faster. "03" is faster than "02".



Project 134

Word Fan Arcade Show

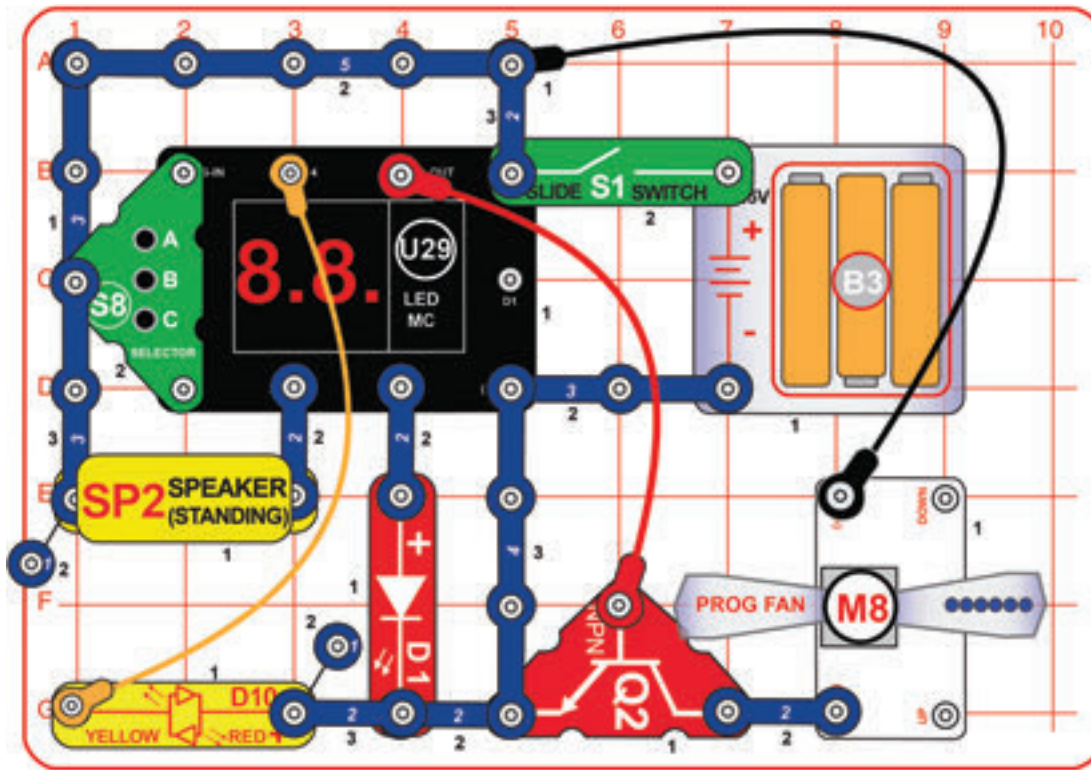

Turn on the slide switch (S1); the display on the LED-MC (U29) shows "00". Press the A button on the selector (S8) once to make the display show "01", then press the B button on the selector to start.

Every few seconds one or more of the following will happen, randomly changing: the red LED (D1) lights, the yellow LED (D10) lights, the programmable fan (M8) spins and displays a phrase, the speaker plays a tune, and the U29 LED display pattern changes.

WARNING: Moving parts. Do not touch the fan during operation.

Alternate connections for speaker (a little louder):

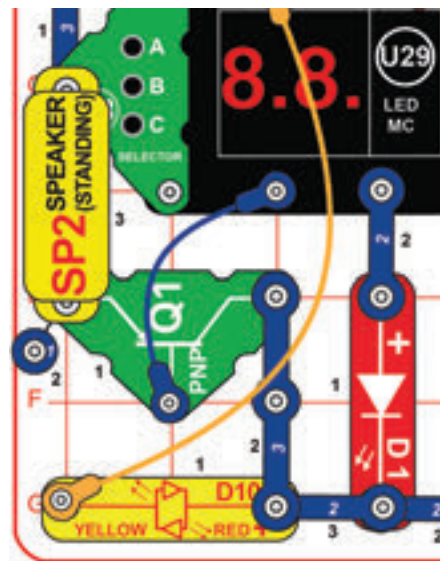

Project 135 Fast Word Fan Arcade Show

Use the preceding circuit. Turn on the slide switch (S1); the display on the LED-MC (U29) shows "00". Press the A button on the selector (S8) two or three times to increase the ones digit on the display. When the display shows "02" or "03", press the B button on the selector to start.

The circuit works the same, except that it changes faster ("03" is faster than "02").



Project 136

Light Projecting Arcade Show

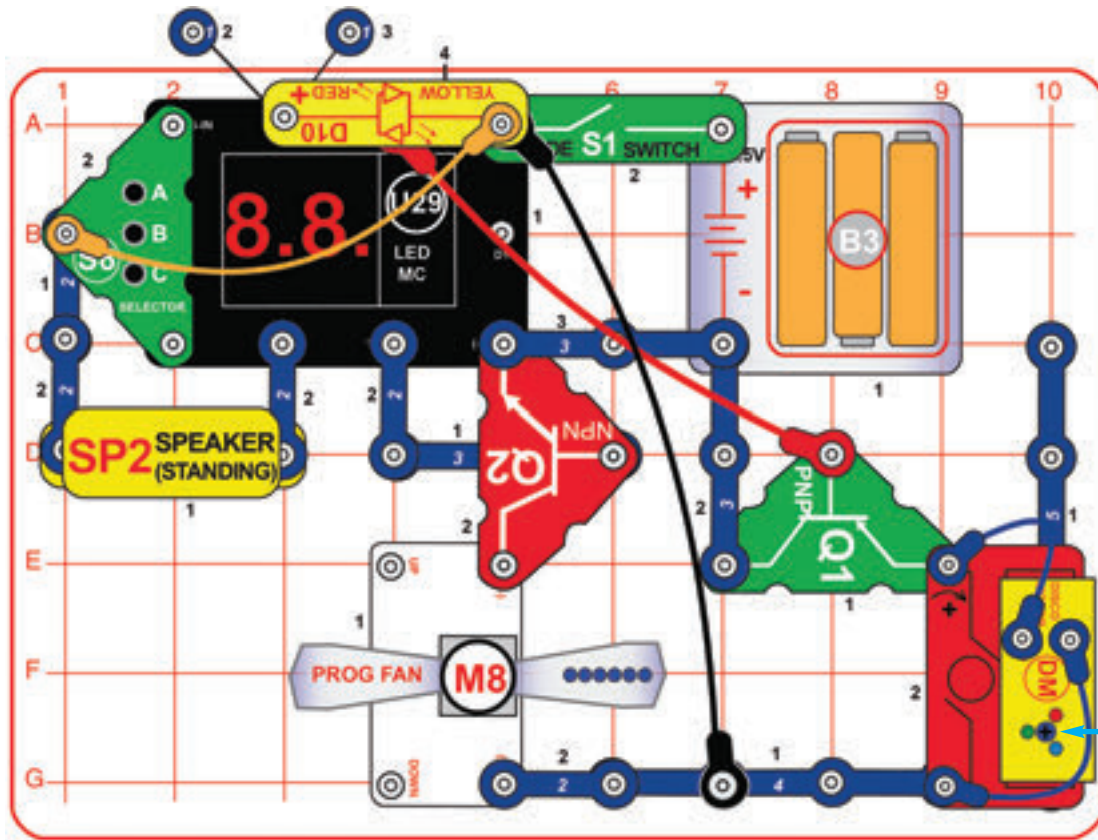

Build the circuit as shown. Note that there is a 3-snap wire under the NPN transistor (Q2) that is partially hidden, and a 5-snap wire under the disco motor (DM), partially hidden.

Turn on the slide switch (S1). The display on the LED-MC (U29) displays "00", the programmable fan (M8) spins & lights, and the disco motor (DM) spins & lights. Press the A button on the selector (S8) once to make the display show "01", then press the B button on the selector to start.

Every few seconds one or more of the following will happen, randomly changing: the yellow LED (D10) lights, the programmable fan spins & lights, the disco motor spins & lights, the speaker plays a tune, and the U29 LED display shows a random pattern.

WARNING: Moving parts. Do not touch the fan while it is spinning.



Project 137

Fast Light Projecting Arcade Show

Use the preceding circuit. Turn on the slide switch (S1); the display on the LED-MC (U29) shows "00". Press the A button on the selector (S8) two or three times to increase the ones digit on the display. When the display shows "02" or "03", press the B button on the selector to start.

The circuit works the same, except that it changes faster. "03" is faster than "02".



Project 138

Where's the Blue Light?

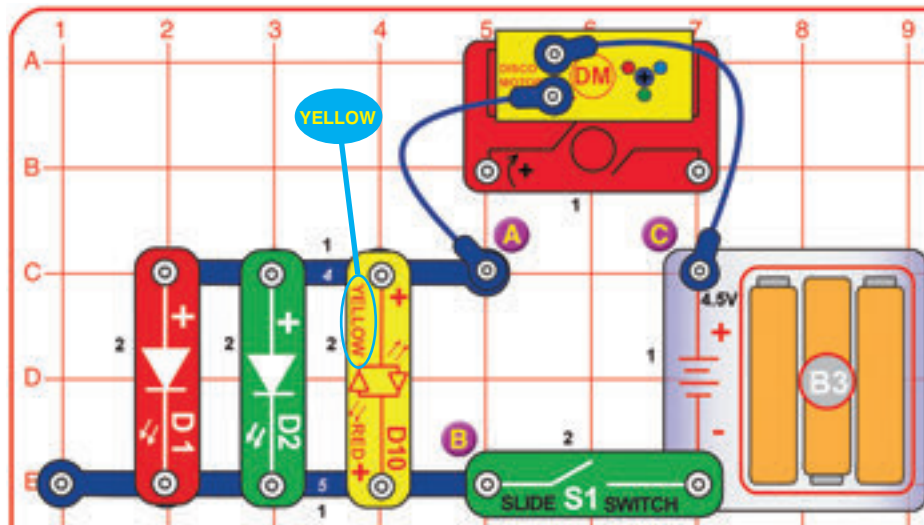

Turn on the slide switch (S1). The red, green, and yellow LEDs (D1, D2, & D10) should be on, along with the red, green, and possibly the blue LEDs on the disco motor (DM). The blue LED on the disco motor may be dim or off.

The battery voltage is split between two groups of LEDs - the D1/D2/D10 LEDs, and the red/green/blue LEDs in the disco motor. The blue LED in the disco motor needs more voltage to operate properly than the other colors, and the reduced voltage to it may not be enough to light it. The red & green LEDs in the disco motor may be brighter than the D1 & D2 LEDs of the same color, due to the quality and style of the actual LEDs used.

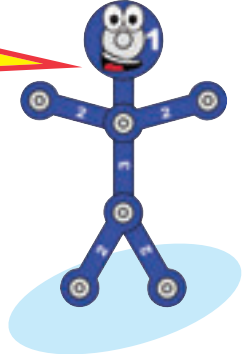

Project 139 There's the Blue Light

Use the preceding circuit, but add the press switch (S2) across the points marked A & B. Turn on S1 and push S2. With S2 pressed, the LEDs on the disco motor all shine brightly, but the others are off.

Pressing S2 bypasses the D1, D2, & D10 LEDs, so the LEDs on the disco motor get the full battery voltage, making them brighter. This really helps the blue LED on the disco motor, because it needs lots of voltage to operate properly.



Project 140 No Blue Light

Use the preceding circuit, but place the S2 across points A & C instead of across points A & B. Turn on S1 and push S2. With S2 pressed, the LEDs on the disco motor are off, but the others are shining brightly.

Pressing S2 bypasses the LEDs in the disco motor, so the D1, D2, & D10 LEDs, get the full battery voltage, making them brighter.



Project 141 Dim Green Light

Use the project 138 circuit, but remove 2 of the 3 LEDs (leaving D1, D2, or D10), in the 4 combinations shown below. Compare the brightness of the different LEDs in the disco motor (DM).

- A. D1 in, D2 & D10 out.
- B. D2 in, D1 & D10 out.
- C. D10 in, D1 & D2 out.
- D. D10 in but reversed (so it is red), D1 & D2 out.

Here the battery voltage is split between the remaining LED (D1, D2, or D10) and the group of 3 LEDs in the disco motor. Green LEDs take a little more voltage to operate properly than red or yellow LEDs, so the green LED in the disco motor will be dimmer than the red LED there (but not as dim as the blue LED there). This effect is more apparent when the green D2 LED is in the circuit (combination B).

Project 142

Slow Disco Ball

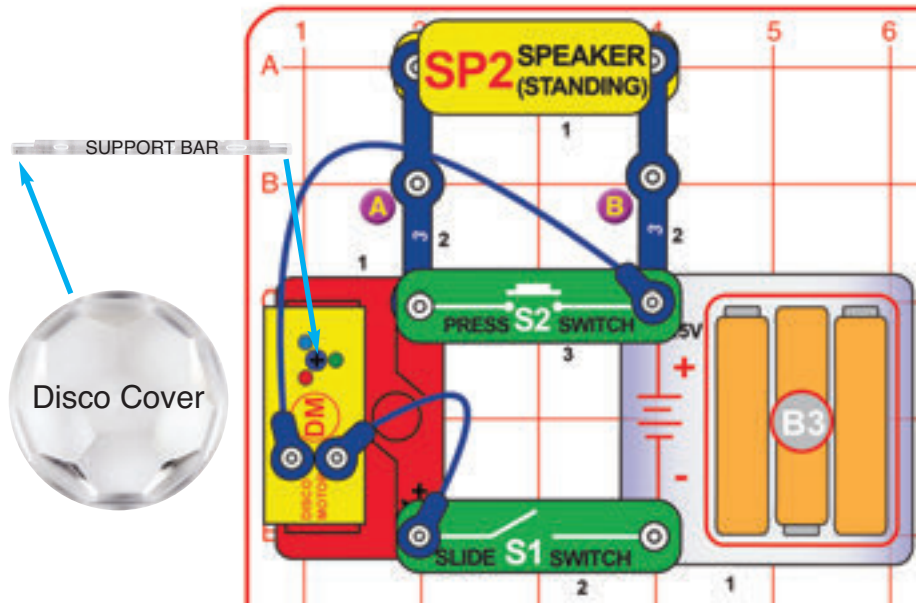

Place one of the disco covers on the disco motor (DM) shaft. Turn on the slide switch (S1), then push and release the press switch (S2). The disco motor (DM) spins, but is not as fast as in project 10.

The resistance of the speaker (SP2) reduces the voltage to the disco motor (DM), slowing it down. The disco motor needs more power to get started than it needs to keep spinning, so the press switch is used to get it started.

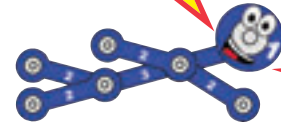

Project 143

Slower Disco Ball

Use the preceding circuit but replace the speaker (SP2) with the red LED (D1, "+" on right). Turn on the slide switch (S1), then push and release the press switch (S2). The disco motor (DM) should be spinning slowly. If it does not continue spinning, then add the red/yellow LED (D10) across points A & B.

The red LED reduces the power to the disco motor more than the speaker did, so the disco motor spins even slower now.

Project 144

Selector with Disco Motor LEDs

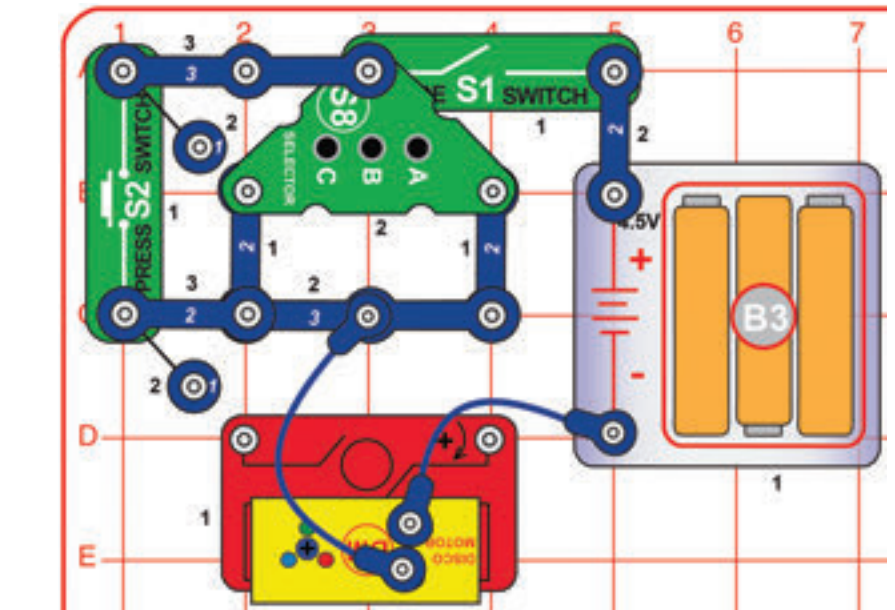

Turn on the slide switch (S1) and press buttons on the selector (S8) to light LEDs in the disco motor (DM). Then push the press switch (S2) to make all the LEDs brighter.

The buttons in the selector (S8) have more electrical resistance than the button in the press switch (S2), so pressing S2 makes the LEDs brighter than pressing the S8 buttons (the difference may be small). Also, the green LED needs more voltage to operate than the red LED, and the blue LED needs more voltage than the green one, so the green & blue LEDs are more affected by the resistance in the S8 buttons than the red LED, and may be dimmer. S2 has almost no resistance, so it makes all the LEDs bright.





Project 145

Selector with Disco Ball?



SUPPORT BAR

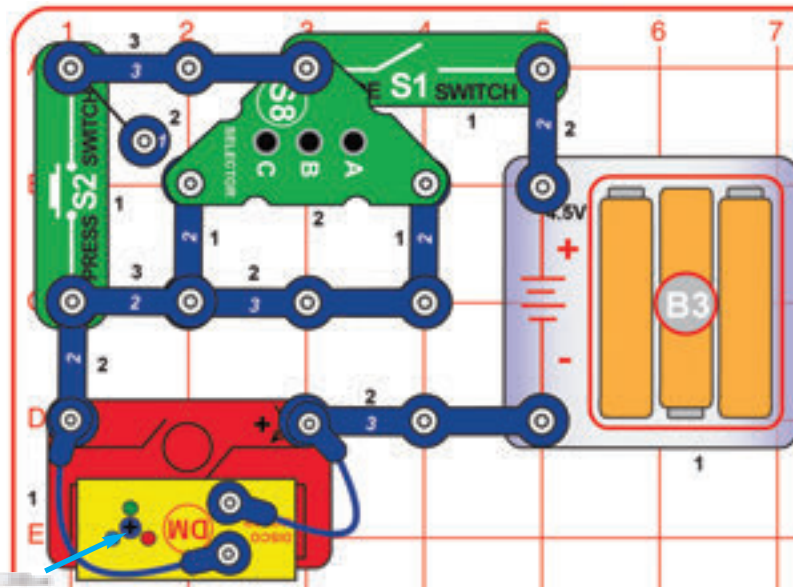

Turn on the slide switch (S1). Press buttons on the selector (S8); the disco motor (DM) may spin slowly, and its LEDs may light. Then push the press switch (S2); the disco motor spins faster and its LEDs are brighter.

The buttons in the selector (S8) have more electrical resistance than the button in the press switch (S2), and the disco motor needs a lot of power to operate, so the selector buttons cannot make the disco motor work as well as the S2 button can.

The selector needs help to control the disco motor - see the next project for the solution.

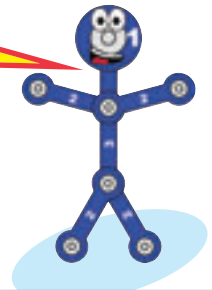

Project 146

Selector with Disco Ball - NPN

SUPPORT BAR

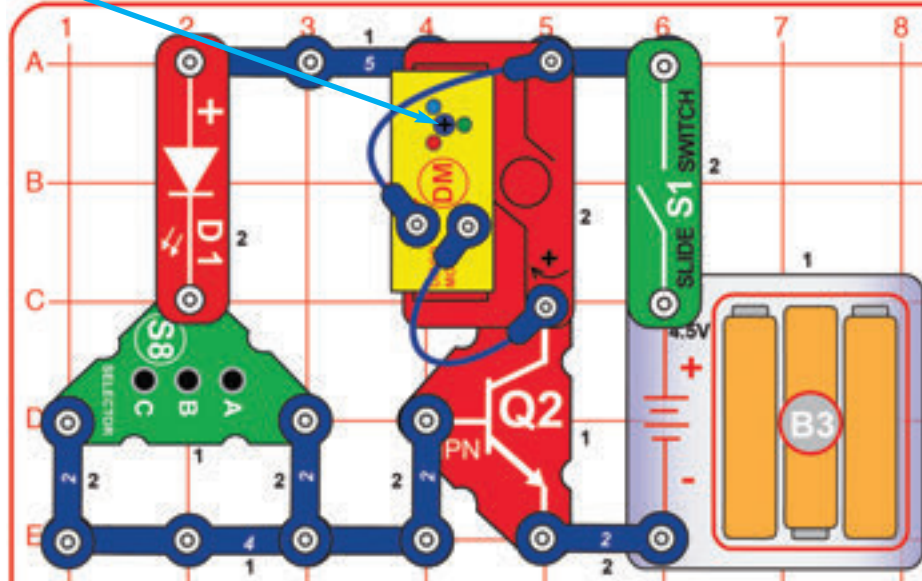

Note that the 5-snap wire is under the disco motor (DM), partially hidden. Place one of the disco covers on the disco motor shaft. Turn on the slide switch (S1), then push the any button on the selector (S8). The disco motor spins and its LEDs light.

The selector (S8) may not be able to properly control the disco motor directly, so this circuit uses the NPN transistor (Q2) to help. A small electric current flowing into the transistor through the selector controls a larger current flowing into the transistor through the disco motor.

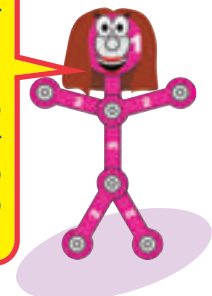



Project 147

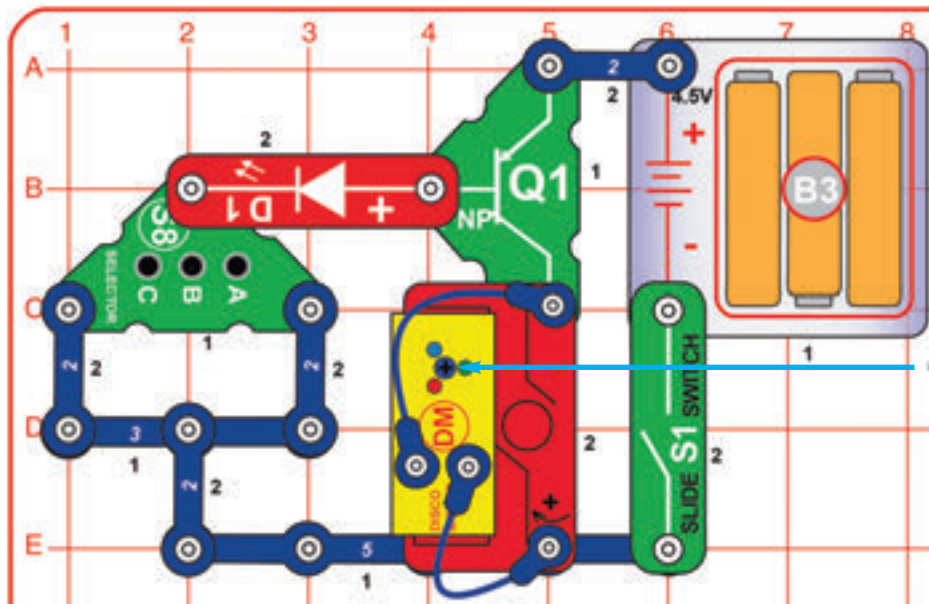

Selector with Disco Ball - PNP

This circuit is just like the preceding one, but uses the PNP transistor (Q1) instead of the NPN transistor (Q2). Note that the 5-snap wire is under the disco motor (DM), partially hidden. Place one of the disco covers on the disco motor shaft. Turn on the slide switch (S1), then push the any button on the selector (S8). The disco motor spins and its LEDs light.



PNP and NPN transistors are similar, but current flows through them in the opposite direction.

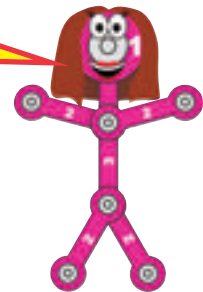

Project 148

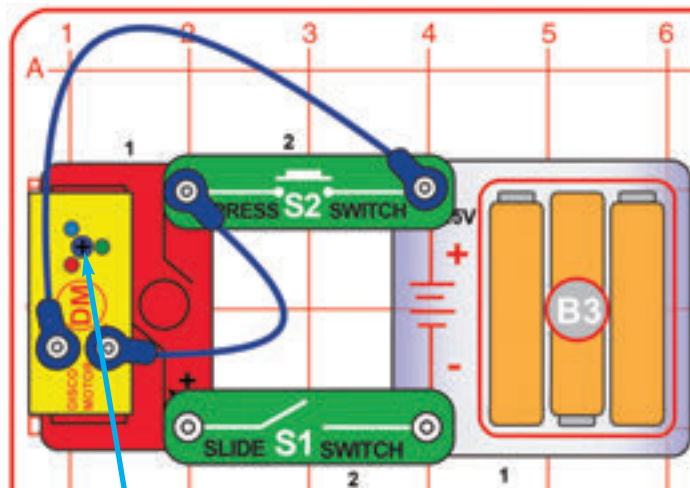

Slower & Dimmer Disco

Place one of the disco covers on the disco motor (DM) shaft. Turn on the slide switch (S1), then push and release the press switch (S2). The disco motor (DM) spins and its LEDs light, but it is not as fast and the LEDs are not as bright as in project 10.

With S2 pressed, the disco motor spins faster but the LEDs do not light. This can help the disco motor to start spinning.

This circuit has the LEDs connected in series with the motor, while project 10 has the LEDs connected in parallel with the motor. Connecting parts in series reduces the power to them, but makes the batteries last longer.

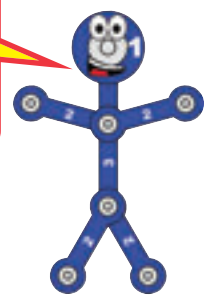



Project 149

Selector with Word Fan

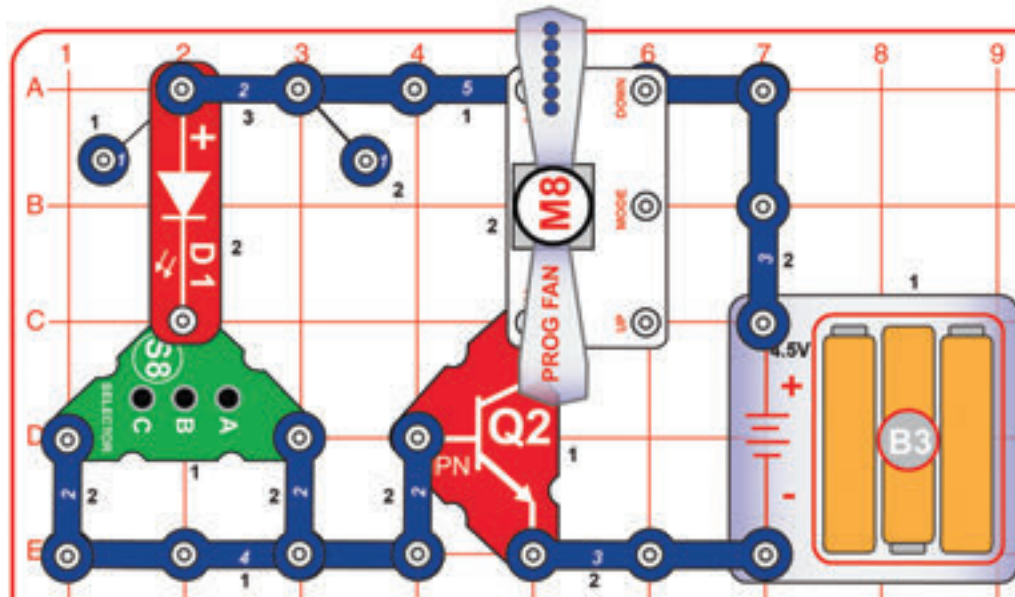

Note that the 5-snap wire is under the programmable fan (M8), partially hidden. Push any button on the selector (S8). The programmable fan spins and displays a message.

The selector (S8) cannot control the programmable fan directly, so this circuit uses the NPN transistor (Q2) to help. A small electric current flowing into the transistor through the selector controls a larger current flowing into the transistor through the programmable fan.

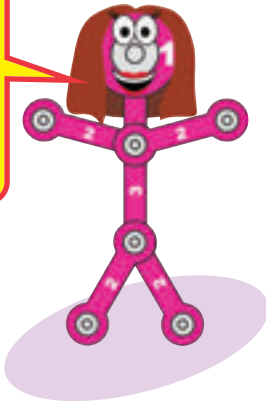

WARNING: Moving parts. Do not touch the fan while it is spinning.



Project 150

Select the Fan

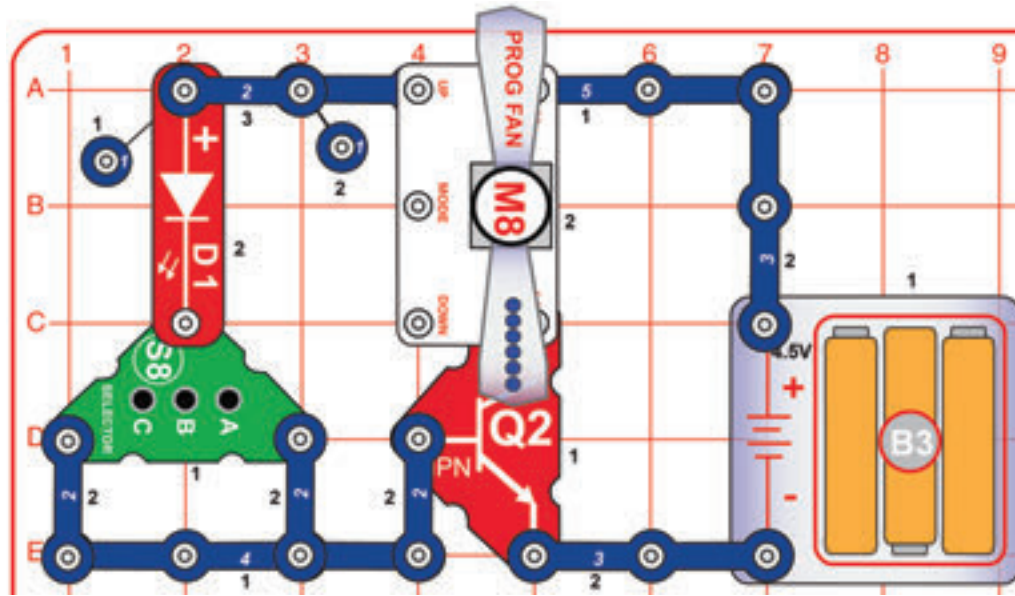

Note that the 5-snap wire is under the programmable fan (M8), partially hidden. Push any button on the selector (S8). The programmable fan spins.

This circuit is like the preceding one, except the programmable fan is reversed. The motor inside it spins the opposite direction, but the LED circuit in it does not function when reversed.

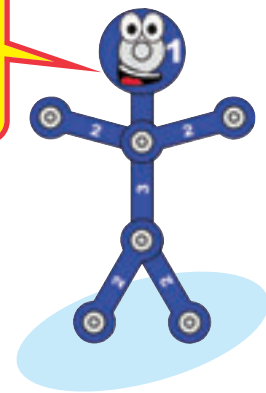

WARNING: Moving parts. Do not touch the fan while it is spinning.

Project 151

Word Fan PNP

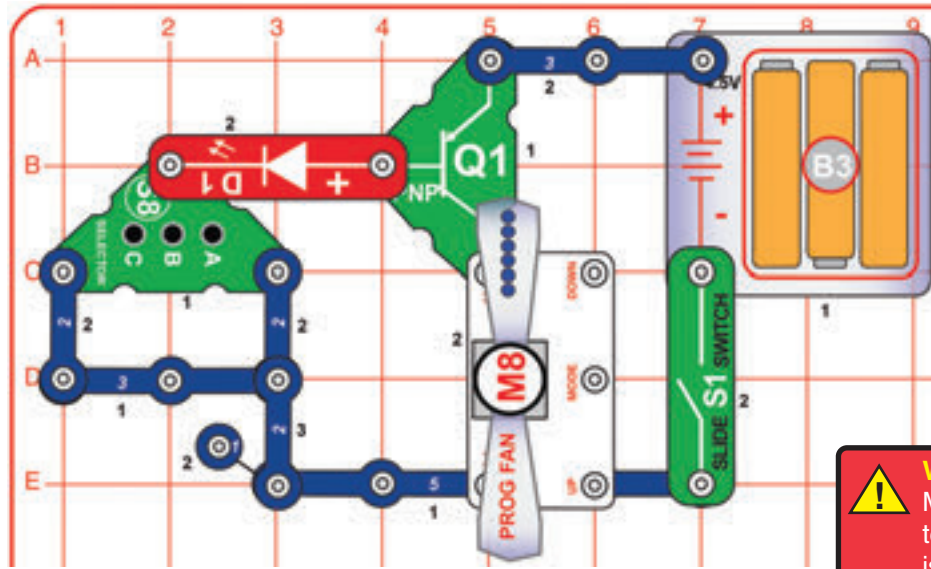

Note that the 5-snap wire is under the programmable fan (M8), partially hidden. Push any button on the selector (S8). The programmable fan spins and displays a message.

PNP and NPN transistors are similar, but current flows through them in the opposite direction.

WARNING: Moving parts. Do not touch the fan while it is spinning.

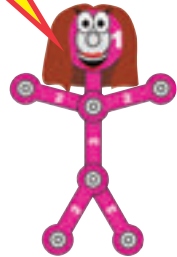

Project 152 Fan PNP

Use the preceding circuit but reverse the programmable fan (M8). The circuit works the same, except that the fan does not display a message.

Project 153

Bi-Color Swing Circuit

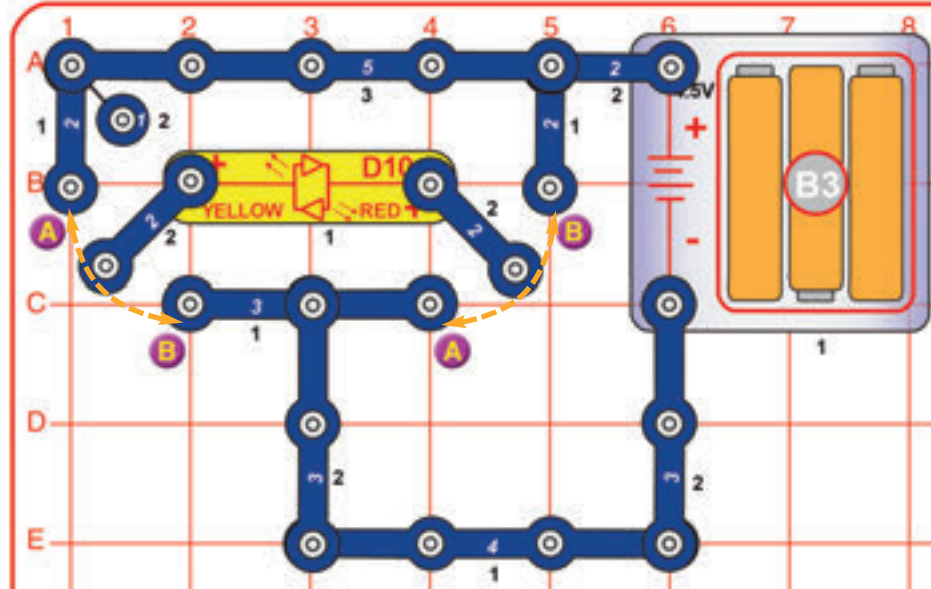

Build the circuit as shown, but note that two 2-snap wires are not snapped at one end but are left to swing between connections. Touch both of the loose 2-snaps to either the A or the B points on each side to complete the circuit and light the red/yellow LED (D10). The LED will be either red or yellow, depending on whether you touched it to the A or B points.

The red/yellow LED has separate red & yellow LEDs connected in opposite directions.

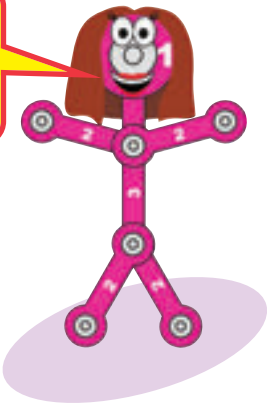

Project 154

Adjusting Disco Cover Focus

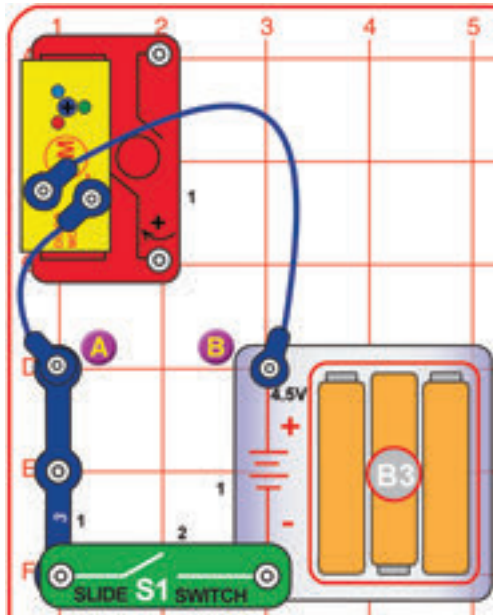

Turn on the slide switch (S1), and place the circuit in a dimly lit room with a flat ceiling. Hold one of the disco covers over the LEDs on the disco motor (DM), without using its support bar. Vary the height over the LEDs and see how it affects the focus.

You can also try holding the circuit at an angle near a wall, and see how the patterns look on the wall.

The disco covers are lenses, and changing their distance above the LEDs changes the focus of the light.



Project 155

Diffused Light

Use the preceding circuit but remove the disco motor (DM) and place the red, green, or yellow LEDs (D1, D2, or D10) across points A & B in the circuit (“+” on LED to point B).

Turn on the slide switch (S1), and place the circuit in a dimly lit room with a flat ceiling. Hold one of the disco covers over the LED. Vary the height and see how it affects the focus.

The LEDs in the disco motor are brighter than D1/D2/D10 LEDs, and also have their focused light more directly upward. The D1/D2/D10 LEDs spread their light over a wider viewing angle, so they can be easily seen from the side.

Project 156

Your Light Patterns

Take a small flashlight in your home and hold one of the disco covers over it. View it in a dimly lit room with a flat ceiling, or point it towards a wall. Vary the height over the flashlight and see how it affects the pattern and focus.

Try this with both an incandescent light bulb flashlight, and with an LED flashlight if you have one.

Results will depend on the light source used, but generally LEDs will produce better patterns than incandescent light bulbs. Light from LEDs tends to be more focused forward, while light from incandescent bulbs goes in all directions (and is usually reflected forward with a mirror).



Project 157

Pressure Circuit

Build the circuit as shown, then push on point A with your finger to complete the circuit.

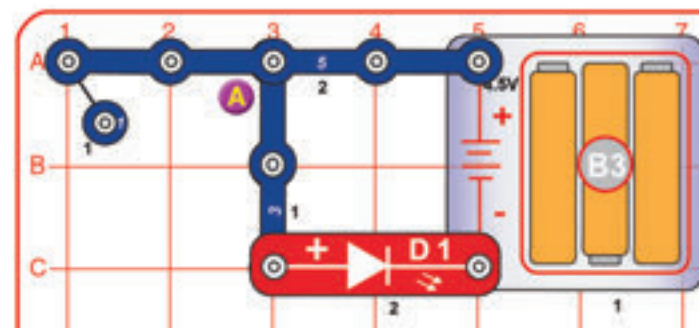

It may appear that the 3-snap and 5-snap wires are touching, but they do not actually touch unless you push them together.

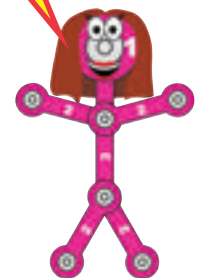



Project 158

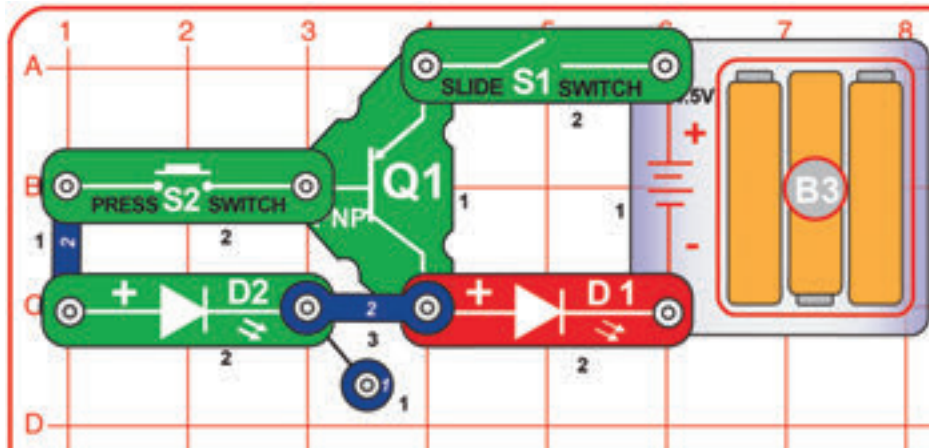

PNP Transistor

Turn on the slide switch (S1) - nothing happens. Now push the press switch (S2) and the red LED (D1) lights, but the green LED (D2) stays off.

A transistor uses a small electric current to control a large electric current. Here pressing S2 makes a small current flow out of the PNP transistor (Q1) through the green LED, which triggers a large current out of the transistor through the red LED. The green LED is actually turned on, but is so dim you may not be able to see it even in a dark room.

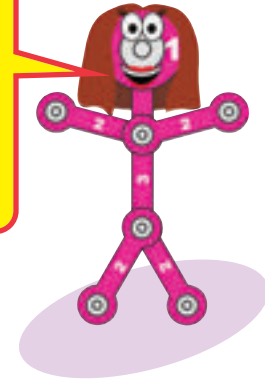

Project 159

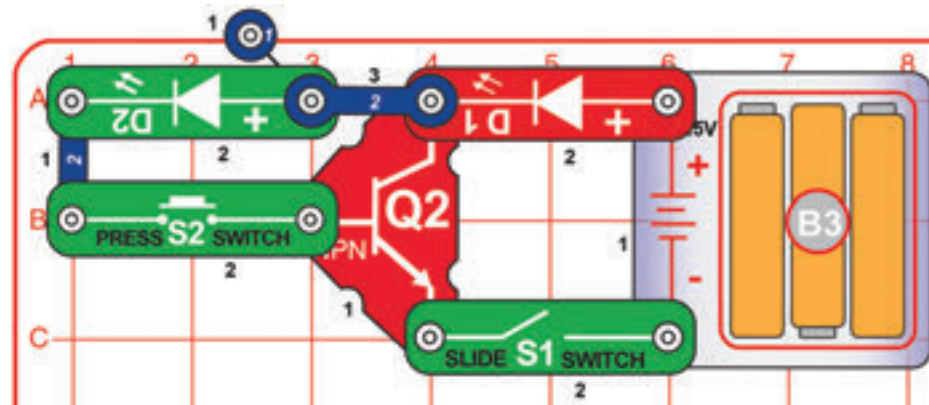

NPN Transistor

Turn on the slide switch (S1) - nothing happens. Now push the press switch (S2) and the red LED (D1) lights but the green LED (D2) stays off.

The NPN transistor (Q2) is just like the PNP transistor (Q1) in preceding circuit, except that the electric currents flow in the opposite direction. Here pressing S2 makes a small current flow into the transistor through the green LED, which triggers a large current into the transistor through the red LED. The green LED is actually turned on, but is so dim you may not be able to see it even in a dark room.

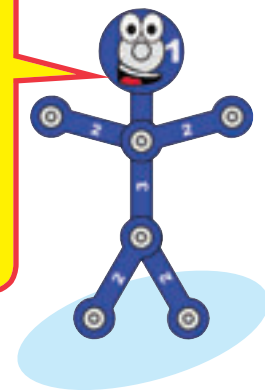



Project 160

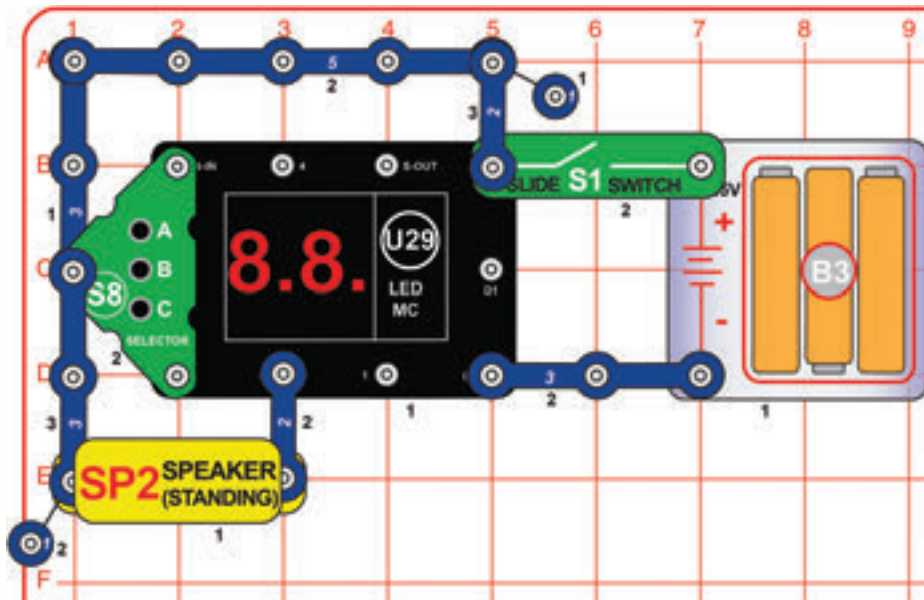

6-Sided Dice Game: Race to the Finish

Use this circuit and select Game 5 using the game selection procedure in project 17. The game begins when you see “Go” in the display.

This game is for 2 or more players where each player has a number track as shown below (draw one track for each player). Players take turns rolling the six-sided dice by pressing button C for a period of time and then releasing it. The object of the game is to be the first player to reach the end of the track. Each player moves along the track by successfully rolling the next number on their track. For instance, at the start of the game a player needs to roll a 0, and then they can cross off the number 0 on the left and on their next turn try to roll a 1. If on their first turn they roll a 0 and a 1, then they can cross off both numbers and try to get a 2 on their next turn. The game continues until one player has crossed off all the numbers, thus reaching the finish line and winning the game.

First Player – 0 1 2 3 4 5 6 6 5 4 3 2 1 0
 Second Player – 0 1 2 3 4 5 6 6 5 4 3 2 1 0



Project 161

6-Sided Dice Game: Difference Maker

Use the Project 160 circuit and select Game 5 using the game selection procedure in project 17. The game begins when you see “Go” in the display.

This game is for 2 or more players where each player starts with 500 points. Players should sit in a circle and take turns in a clockwise fashion rolling the six-sided dice by pressing button C for a period of time and then releasing it. Each player compares their roll to the previous players roll. If the current players roll is higher than the previous players roll, then the current player takes points away from the previous player based on the difference between their rolls. If the current player’s roll is lower than the previous player’s roll, then the current player gives points to the previous player based on the difference between their rolls. For instance, if Player 1 rolls a 35 and then Player 2 rolls a 50, then Player 2 takes 15 points away from Player 1 (so Player 1 is left with 485 points and Player 2 now has 515 points). If a player runs out of points, then they are out. Note that if Player 1 only has say 10 points left and then Player 2 rolls a number 20 points higher than Player 1, then Player 1 is out and Player 2 gets 10 more points (not 20 more points because Player 1 only had 10 points to give Player 2). The last person to not run out of points is the winner.



Project 162

6-Sided Dice Game: Don’t Go Low

Use the Project 160 circuit and select Game 5 using the game selection procedure in project 17. The game begins when you see “Go” in the display.

This game is for 2 or more players where each player starts with 5 lives. Players should sit in a circle and take turns in a clockwise fashion rolling the six-sided dice by pressing button C for a period of time and then releasing it. Each player decides whether they want to keep their first roll or roll the dice again, but if they decide to roll the dice again, they must stay with the number from their second roll. After each player has rolled, the player with the lowest score loses a life. The last player with lives remaining is the winner.

Project 163

6-Sided Dice Game: Free the Frogs

Use the Project 160 circuit and select Game 5 using the game selection procedure in project 17. The game begins when you see “Go” in the display.

This game is for 2 or more players where each player starts with 6 frog cages labeled 1 through 6. Every player also has 6 frogs. Before play begins, each player decides where to place their frogs. They could put 1 frog in each of the 6 cages, or they could put all their frogs in one cage, or anything in between (for example: two frogs in cage 1, three frogs in cage 4 and one frog in cage 6). Once every player has decided where to place their frogs, then the players should sit in a circle and take turns in a clockwise fashion rolling the dice by pressing button C for a period of time and then releasing it. If a player has a frog in the cage labeled by one of the numbers rolled, then they can release a frog from that cage. For example, if a player rolls 36, they can release one frog from cage 3 and one frog from cage 6 if they have frogs in those cages. If a player rolls doubles, for example 66, then they can remove two frogs from cage 6 if they have at least two frogs in cage 6. The first player to release all their frogs wins.

Project 164

6-Sided Dice Game: Free the Fish

Use the Project 160 circuit and select Game 5 using the game selection procedure in project 17. The game begins when you see “Go” in the display.

This game is for 2 or more players and is very similar to the Free the Frogs game. Each player starts with 6 fishbowls labeled 0 through 5. Every player also has 6 fish. Before play begins, each player decides where to place their fish. They could put 1 fish in each of the 6 bowls, or they could put all their fish in one bowl, or anything in between (for example: two fish in bowl 1, three fish in bowl 4 and one fish in bowl 5). Once every player has decided where to place their fish, then the players should sit in a circle and take turns in a clockwise fashion rolling the dice by pressing button C for a period of time and then releasing it. After rolling the dice, the player computes the difference between the two dice and can take one fish out of the bowl labeled with the difference of the two dice. For example if a player rolls 36, then $6 - 3 = 3$ so the player can release one fish from bowl 3 if they have fish in this bowl. The first player to release all their fish wins.

Project 165

6-Sided Dice Game: Free the Foxes

Use the Project 160 circuit and select Game 5 using the game selection procedure in project 17. The game begins when you see “Go” in the display.

This game is for 2 or more players and is very similar to the Free the Frogs and Free the Fish games. Each player starts with 11 barns labeled 2 through 12. Every player also has 11 foxes. Before play begins, each player decides where to place their foxes. They could put 1 fox in 11 different barns, or they could put all their foxes in one barn, or anything in between (for example: two foxes in barn 3, five foxes in barn 8 and four foxes in barn 11). Once every player has decided where to place their foxes, then the players should sit in a circle and take turns in a clockwise fashion rolling the six-sided dice by pressing button C for a period of time and then releasing it. After rolling

the dice, the player computes the sum between the two dice and can take one fox out of the barn labeled with the sum of the two dice. For example if a player rolls 36, then $3 + 6 = 9$ so the player can release one fox from barn 9 if they have a fox in this barn. The first player to release all their foxes wins.

After playing all three games for a while (Free the Frogs, Free the Fish and Free the Foxes), do you see different strategies in where best to place the animals across the three different games? There are definitely different strategies that give you the best chance to win based on the probabilities of the dice numbers, differences, or sums being certain values.



Project 166

6-Sided Dice Game: Squares

Use the Project 160 circuit and select Game 5 using the game selection procedure in project 17. The game begins when you see "Go" in the display.

This game is for 2 or more players. Players should sit in a circle and take turns in a clockwise fashion rolling the dice by pressing button C for a period of time and then releasing it. After rolling the dice, take the difference between the two numbers. Then in the grid below, the player can shade in a line adjacent to the difference between the two dice. For instance, if a player rolled 36, then $6 - 3 = 3$ so the player can shade in one of the dotted lines above, below, to the left, or to the right of the number 3 in the grid below. If the player is able to shade in the last dotted line around a box, then that player gets the number of points in the box. For instance, if one of the boxes with a 5 in it already has the top, bottom, and left sides shaded in, and then a player rolls a 61 (difference of 5), the player can then shade in the right side of the box and get 5 points. If a player rolls a difference for which there are no more dotted lines adjacent to the difference number, then the player loses their turn. After all dotted lines have been shaded in, the player with the most points wins.

1	4	2	3	3	2	4	5	0
4	5	1	0	1	5	0	2	4
3	2	5	3	2	0	3	4	5
0	5	3	4	3	2	1	5	1
2	1	0	4	0	5	0	2	3
3	4	2	1	5	4	3	0	2
0	1	0	5	3	1	2	1	4
2	5	4	1	4	5	3	1	0



Project 167

6-Sided Dice Game: Coin Dice

You need a coin for this game. Use the Project 160 circuit and select Game 5 using the game selection procedure in project 17. The game begins when you see "Go" in the display.

This is an individual game of player versus the house where the player starts out with 200 points. The player flips a coin and rolls the dice by pressing button C for a period of time and then releasing it. If the player flips a heads, then the player wins the number of points in the 2nd column of the table below depending on what number they rolled. If the player flips a tails, then the player loses the number of points in the 3rd column of the table below depending on what number they rolled. The player wins if they can get to 400 points, but lose if they lose all their points.

Dice Roll	Heads (player wins)	Tails (House wins)
12 through 16	2 points	-7 points
21, 23 through 26	6 points	-9 points
31, 32, 34 through 36	10 points	-11 points
41 through 43, 45, 46	14 points	-13 points
51 through 54, 56	18 points	-15 points
61 through 65	20 points	-16 points
Doubles (11,...55, 66)	30 points	-25 points

Project 168

6-Sided Dice Game: Baseball

Use the Project 160 circuit and select Game 5 using the game selection procedure in project 17. The game begins when you see “Go” in the display.

This game can be played in solitaire or with 2 people. Start by having the visitor team roll the six-sided dice by pressing button C for a period of time and then releasing it. The first number is then used in the lookup table below to determine whether the batter got a Hit (if the first number is 0, 1 or 2) or an Out (if the first number is 3 or higher).

First number in dice roll	Result
0, 1, or 2	Hit
3 through 6	Out

If the first number in the roll was a Hit, then use the second number in the roll to lookup the hit result in the table below. Note that runners only advance 1 base on a single and walk, and only advance 2 bases on a double unless indicated otherwise in the table.

Second number in dice roll	Result
1	Single
2	Walk
3	Double
4	Triple
5	Single, runner on 2nd base scores
6	Home run

If the first number in the roll was an Out, then use the second number in the roll to lookup the hit result in the table below.

Second number in dice roll	Result
1	Strikeout
2	Groundout, all runners advance
3	Shallow Flyout, all runners hold
4	Deep Flyout, runners on 2nd base or 3rd base advance
5	Groundout, double play if runner on 1st base, all other runners advance
6	Error, runner safe at 1st base, all other runners advance

Project 169

Simple Alarm Sounds

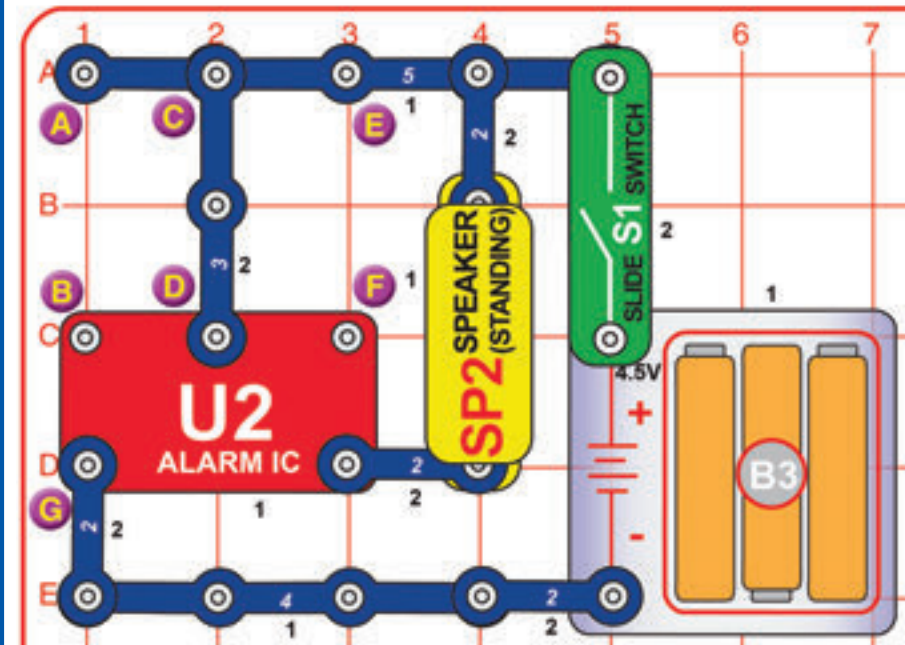

Turn on the slide switch (S1) to hear an alarm.

Variants:

1. Connect a blue jumper wire between points A & B.
2. Move the blue jumper wire to points E & F.
3. Move the blue jumper wire to points B & G.
4. Remove the blue jumper wire. Remove the 3-snap wire between points C & D, and connect it between points A & B.

Project 170 Green & Lots More

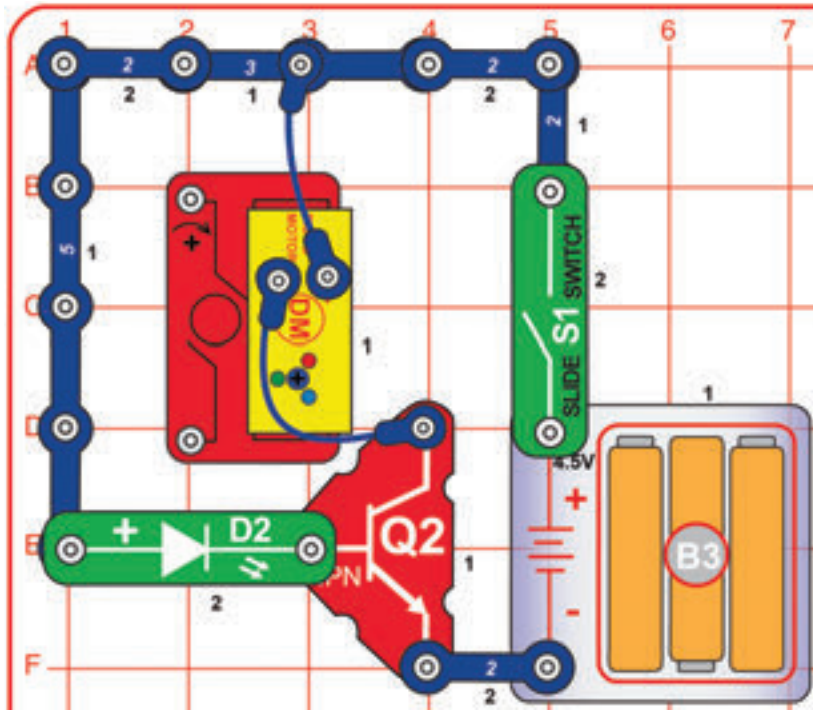

Turn on the slide switch (S1). The green LED (D2) and all LEDs on the disco motor (DM) light.

Compare this circuit to project 159. Here the current through the green LED (D2) controls the current through the LEDs on the disco motor (DM) using the NPN transistor (Q2), making all the LEDs on the disco motor bright.

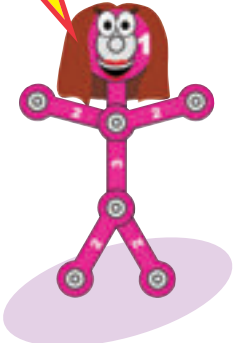

Project 171

Red or Yellow & Lots More

Use the preceding circuit, but replace the green LED (D2) with the red LED (D1, "+" on left) or the red/yellow LED (D10, in either direction).

Project 172

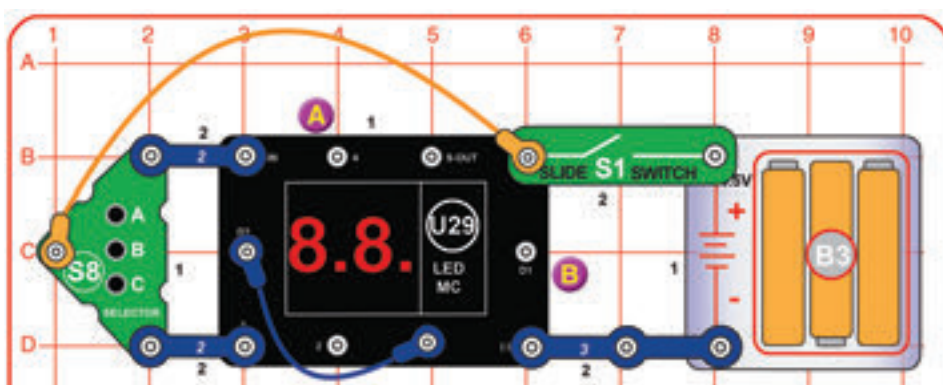

Vibrato 2

Turn on the slide switch (S1); the display on the LED-MC (U29) shows "00". Press the A button on the selector (S8) to increase the ones digit on the display, and press the C button on the selector to increase the tens digit on the display. When the display shows "21", press the B button on the selector to start.

The "2" in the display will be toggling on/off at a varying rate.

Project 173

Vibrato 21

Use the preceding circuit, but add a second blue jumper between points A & B. Now both digits on the display are toggling, but opposite to each other.



Project 174

Random Bi-Color Light

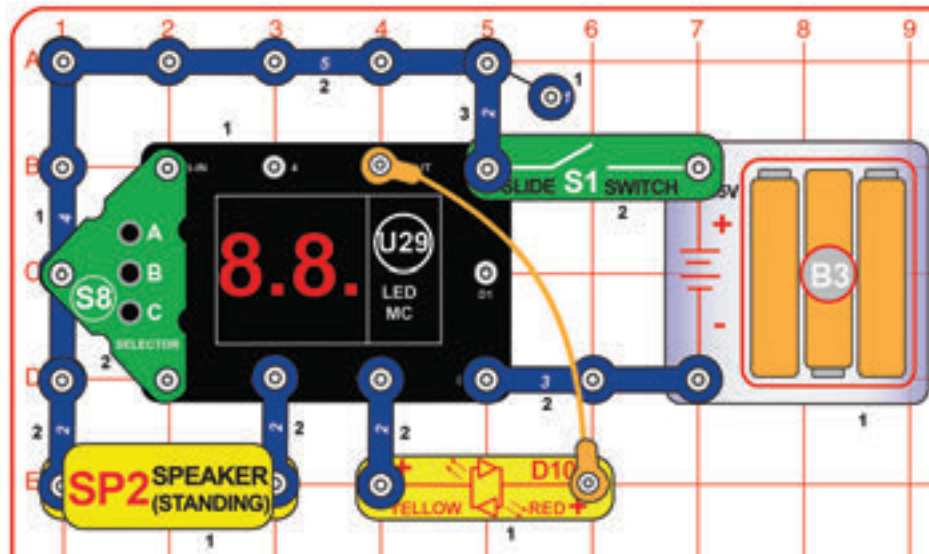

Turn on the slide switch (S1); the display on the LED-MC (U29) shows "00". Press the A button on the selector (S8) three times to make the display show "03", then press the B button on the selector to start.

Every few seconds the speaker (SP2) randomly plays one of three siren sounds, the U29 LED display shows a random pattern, and the red/yellow LED (D10) will be either red, yellow, or off.

You can slow this circuit down by selecting game "01" or "02" on the display instead of game "03".

The red/yellow LED (D10) is a bi-color LED, which means it has two LEDs (red & yellow) inside, connected in opposite directions.

Notice that when D10 is changing colors quickly, its red and yellow colors tend to blend into orange.

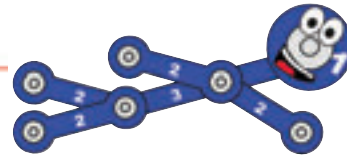

Project 175

Random Bi-Color Lights

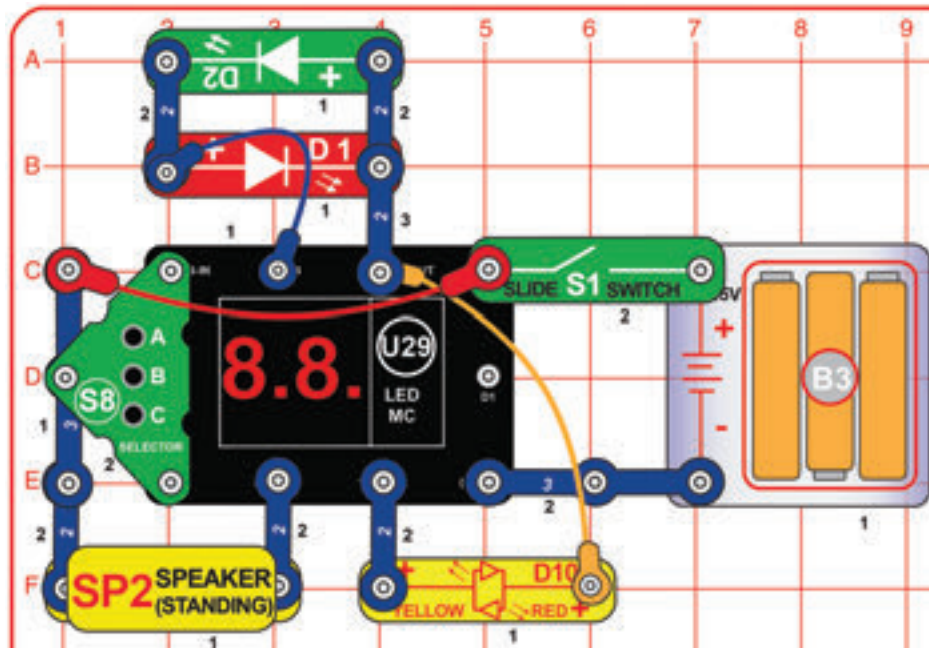

This circuit works the same as the preceding one, but adds more lights.

The red & green LEDs (D1 & D2) are connected in opposite directions between the same points in the circuit, simulating a second bi-color LED.

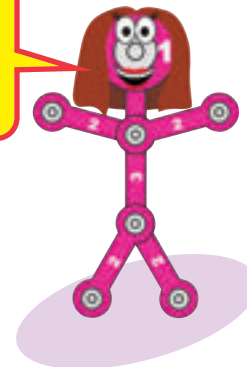

Project 176 Arcade Blinking Display

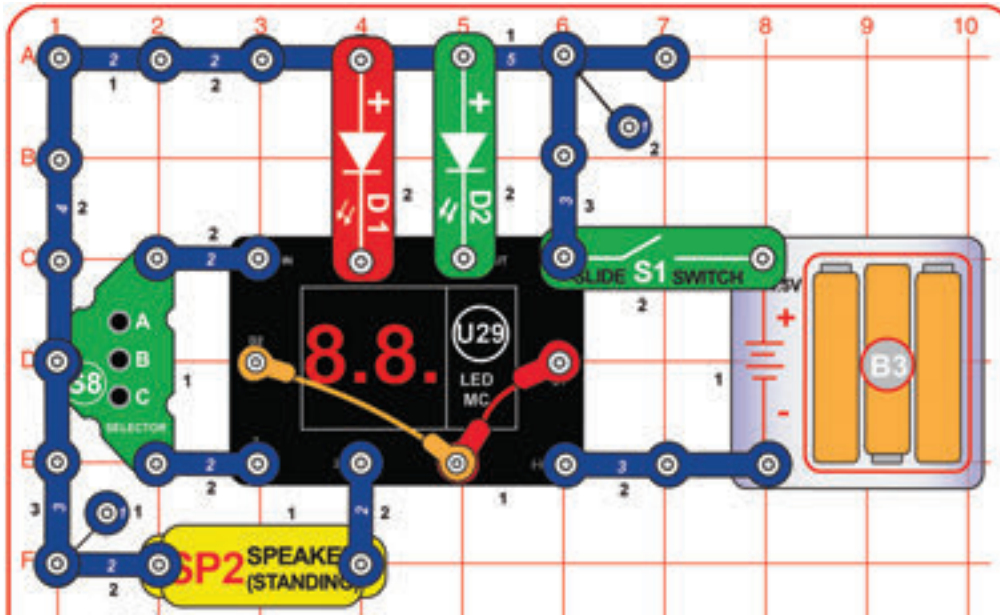

Turn on the slide switch (S1); the display on the LED-MC (U29) shows "00". Press the A button on the selector (S8) three times to make the display show "03", then press the B button on the selector to start.

Every half second the speaker (SP2) randomly plays one of three siren sounds, the U29 LED display shows a random pattern, and the red LED (D1) will be on, the green LED (D2) will be on, or the display on U29 will be blinking.

You can slow this circuit down by selecting game "01" on the display instead of game "02".

Project 177 Blink One

Use the preceding circuit, but remove either one of the red & orange jumper wires. Now only one digit of the LED display blinks.

Project 178

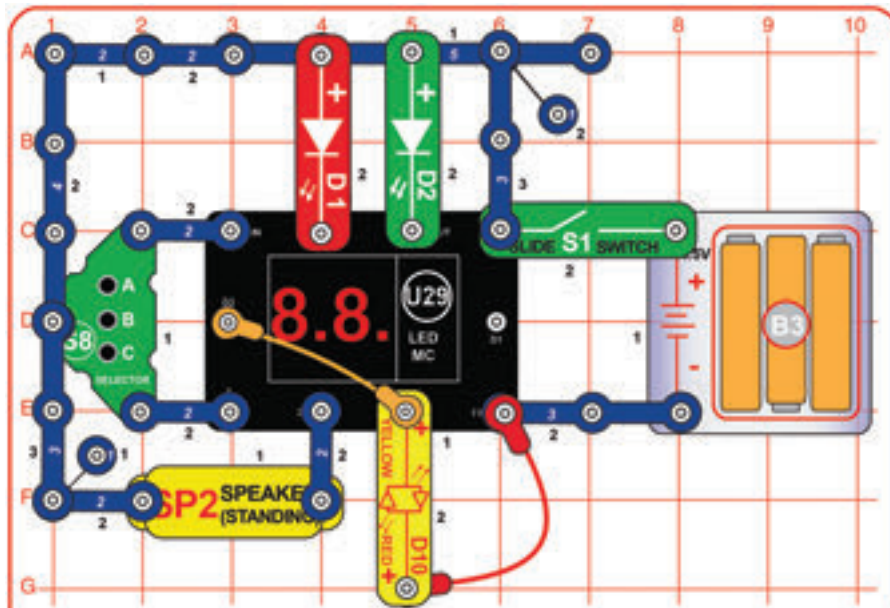

Triple Light Blink One

Modify the project 176 circuit to match this one, which adds the red/yellow LED (D10). It works the same way, but has three LEDs and only the left digit on the display will blink.



Project 179

Disco with Sound

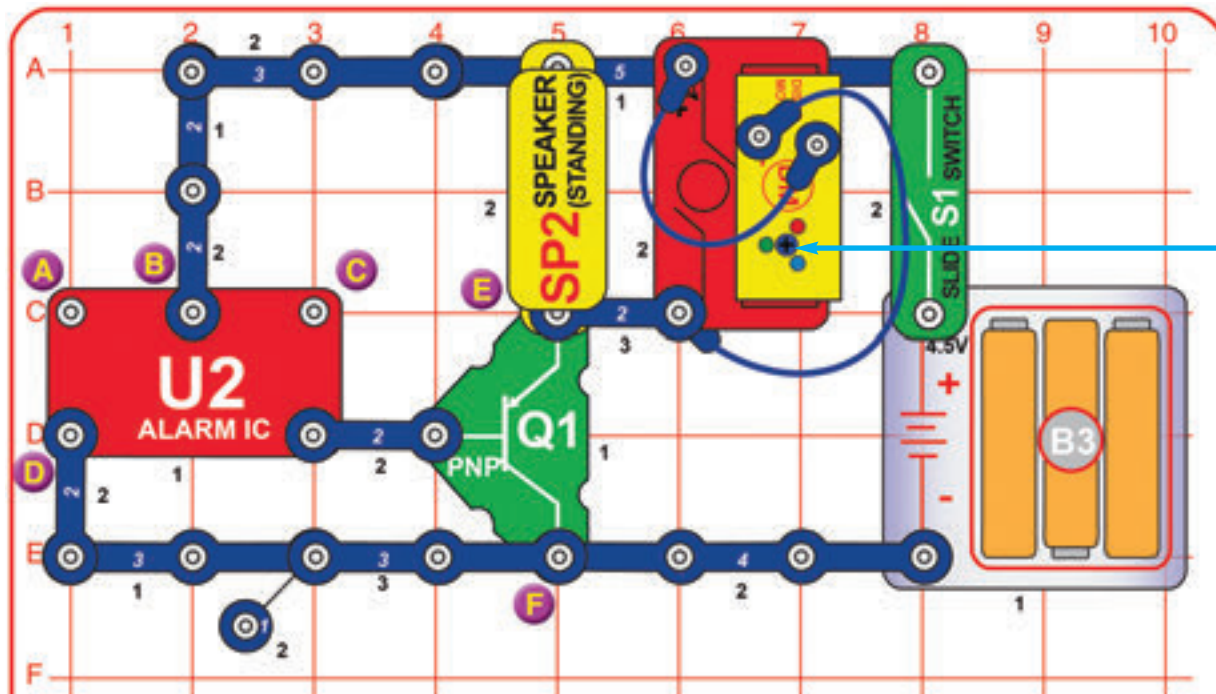

Build the circuit as shown, place of the disco covers on the disco motor (DM), and turn on the slide switch (S1). The speaker (SP2) plays an alarm as the disco cover rotates.



Project 180 Disco with Sound (II)

Use the preceding circuit, but connect points A & B using a 2-snap wire and a 1-snap wire. The sound is different now.

Project 181 Disco with Sound (III)

Use the preceding circuit, but remove the connection between points A & B and instead make a connection between points B & C. The sound is different now.

Project 182 Disco with Sound (IV)

Use the preceding circuit, but remove the connection between points B & C and instead make a connection between points A & D. The sound is different now.

Project 183 Disco with Sound (V)

Use any of the four preceding circuits, but add one of the LEDs (D1, D2, or D10) across points E & F. on level 4 ("+" side to point E). The LED lights, and the sound is not as loud now.



Project 184



Weird Sound

Build the circuit as shown, place of the disco covers on the disco motor (DM), and turn the slide switch (S1). The speaker (SP2) makes sound and the disco cover may rotate.

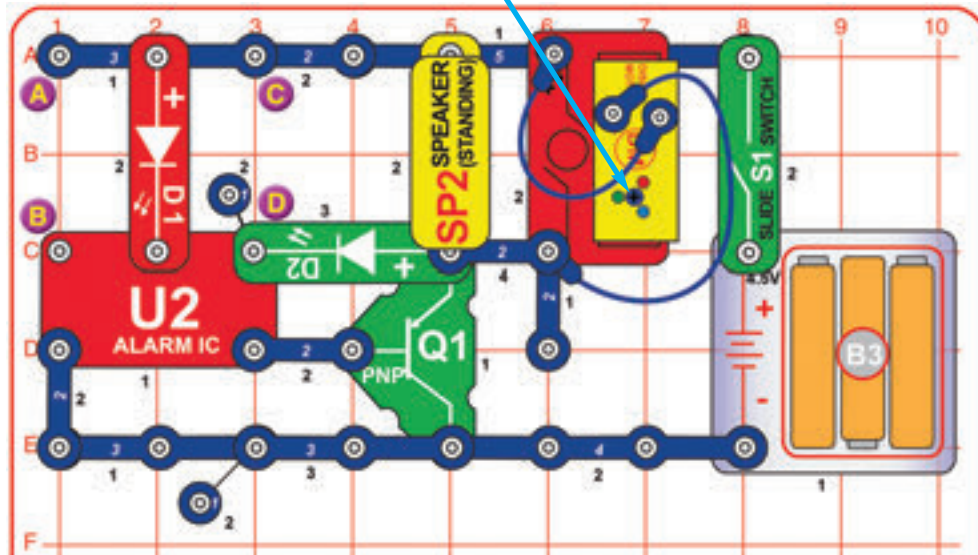

Project 185 Weird Sound (II)

Use the preceding circuit, but add the red/yellow LED (D10, in either direction) across points A & B.

Project 186 Weird Sound (III)

Use the preceding circuit but move the red/yellow LED (D10) from points A & B to points C & D (in either direction). The LED will be on level 4, so you need to stack an extra 2-snap wire on point C.



Project 187

Thyristor Start Disco Ball

Build the circuit as shown, place one of the disco covers on the disco motor (DM), and turn on the slide switch (S1). Nothing happens. Push & release the press switch (S2); the green LED (D2) flashes once, turning on PNP & NPN transistors (Q1 and Q2), so now the disco motor and the LEDs on it turn on. The circuit will continue to run until switch S1 is turned off.

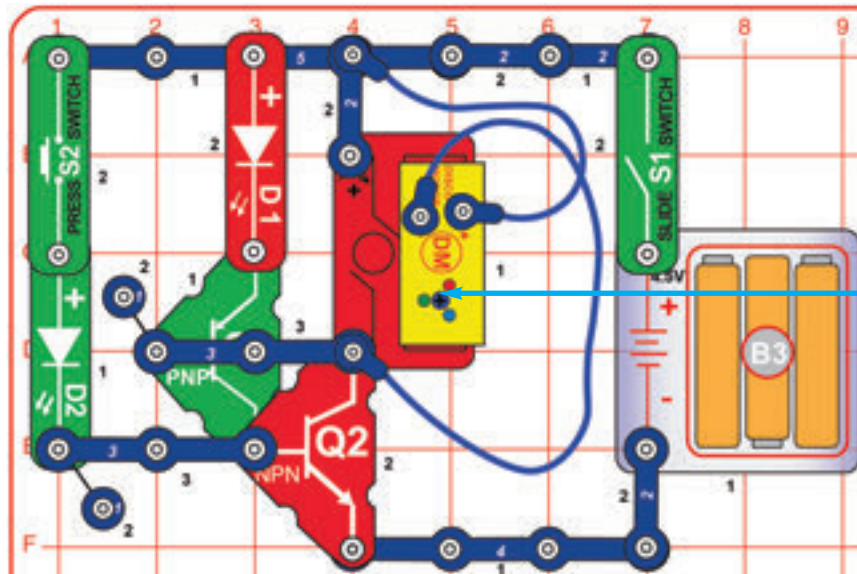

SUPPORT BAR

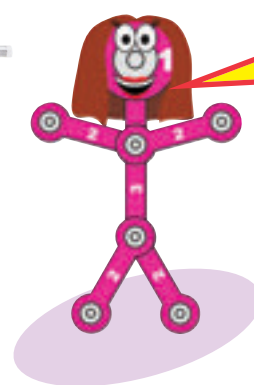

Transistors Q1 and Q2 act as a thyristor bistable switch, conducting electricity when their gate (the left side of Q2) is triggered (by pressing S2), and continuing to conduct until the circuit is turned off.



Project 188

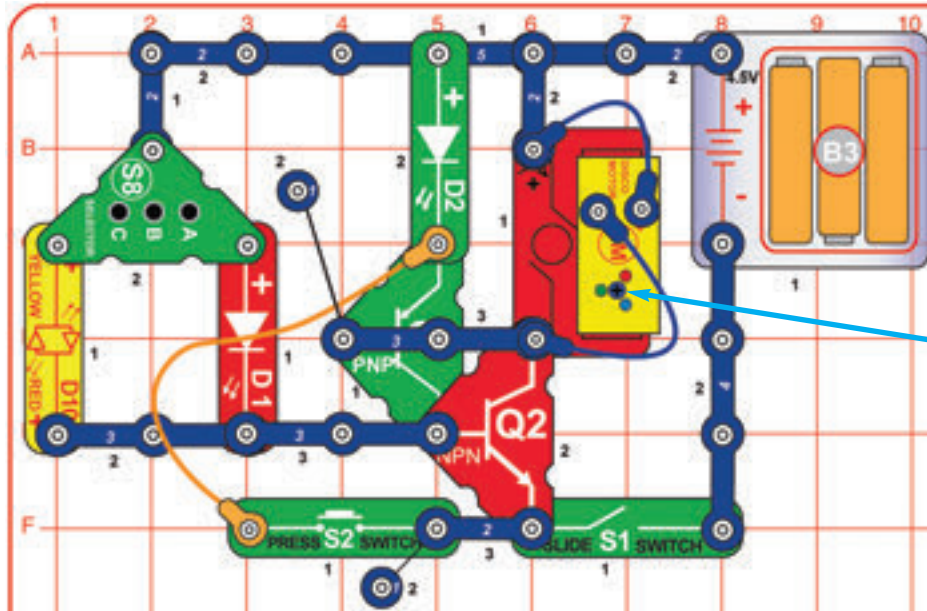

Start Stop Ball

Build the circuit as shown, place one of the disco covers on the disco motor (DM), and turn on the slide switch (S1). Nothing happens. Press & release one of the buttons on the selector (S8) to start the circuit. To stop the circuit, push the press switch (S2) to reset it.

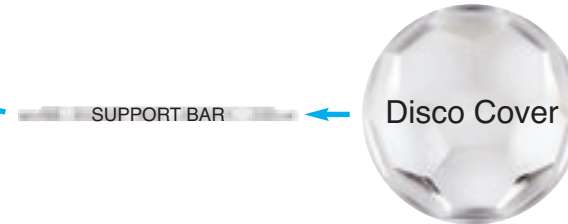

Project 189

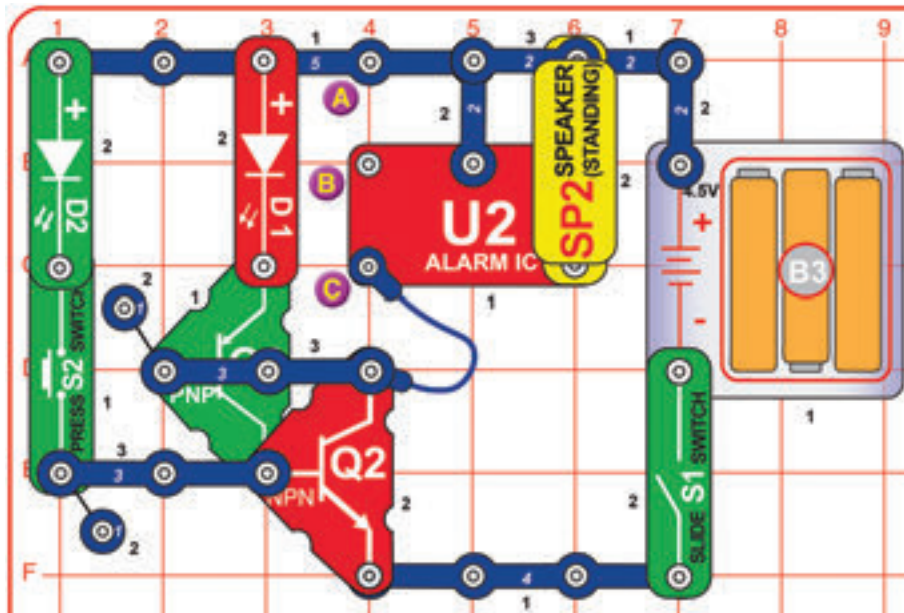

Sound On by Thyristor

Build the circuit as shown and turn the slide switch (S1). Push & release the press switch (S2), the green LED (D2) flashes once, the red LED (D1) lights, and the speaker sounds. Set S1 to off to turn off the circuit.

Project 190 Sound On by Thyristor (II)

Use the preceding circuit, but add a 2-snap wire between the points marked A & B. The sound is different now.

Project 191 Sound On by Thyristor (III)

Use the preceding circuit, but remove the 2-snap wire between points A & B, and add a blue jumper wire between points B & C. The sound is different now.



Project 192

Sound and Light On-Off Thyristor

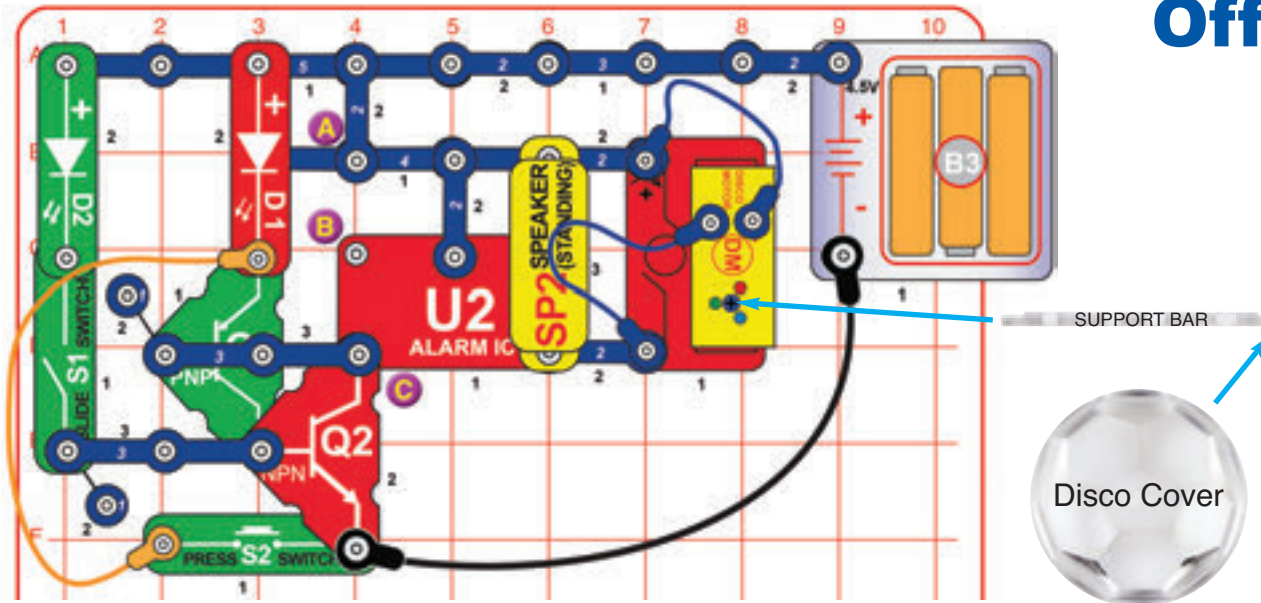

Build the circuit as shown, place one of the disco covers on the disco motor (DM). Turn on the slide switch (S1) and then turn it off (keep it off). The green LED (D2) flashes once, the red LED (D1) lights, and the speaker (SP2) sounds. Push the press switch (S2) to reset the circuit.

Variants:

1. Change the sound by placing the red jumper wire between points A & B.
2. Change the sound by placing the red jumper wire between points B & C.



Project 193

Fan On-Off

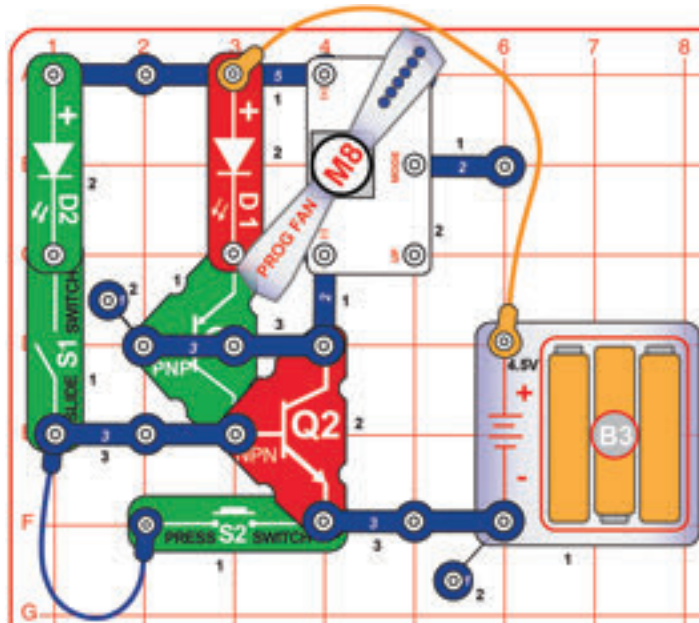

Turn on the slide switch (S1) and then turn it off. The green LED (D2) lights while S1 is on. The red LED (D1) stays on and the programmable fan (M8) spins and displays a message. Push the press switch (S2) and the circuit stops.

WARNING: Moving parts. Do not touch the fan while it is spinning.



Project 194

Add One

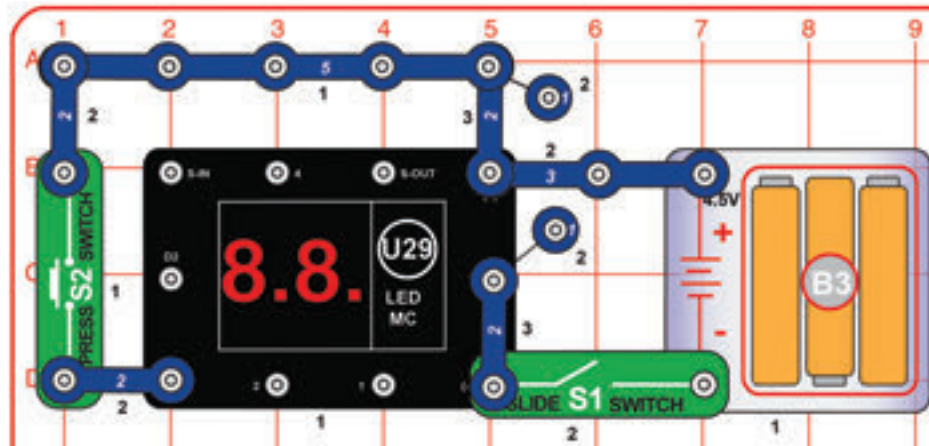

Turn on the slide switch (S1) and the LED-MC (U29) shows only a "0" in the left display. Press S2 and the number 1 shows. Every time you press S2 the number increases by 1, up to number 9. Then the LED-MC (U29) resets to "0" again.



Project 195

Add 10

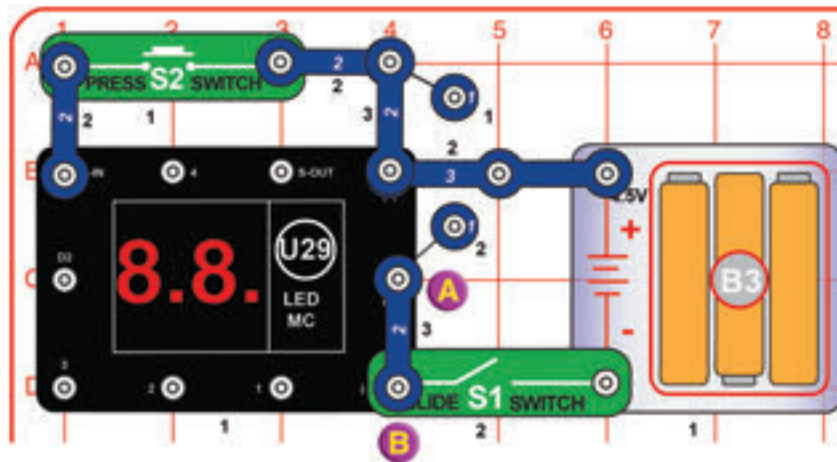

Turn on the slide switch (S1) and the LED-MC (U29) shows "0" in the display. Push the press switch (S2) and the display doesn't change. You need to press S2 ten times for the number to change.



Project 196

Add One at a Time

Remove the 2-snap wire at points A & B. Turn on the slide switch (S1) and the LED-MC (U29) shows only "00". Pressing S2 increases the number by 1, up to 99. Holding down S2 will automatically advance the number.

Play a guessing game. Cover the display and press down S2 for a few short time and stop. Guess a number and then uncover the display.



Project 197

+1 Beeper

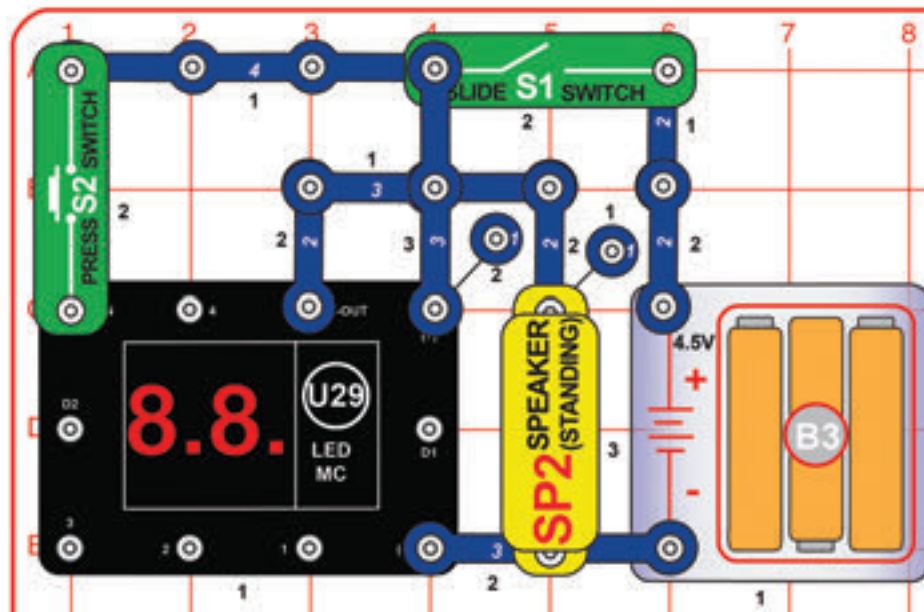

Turn on the slide switch (S1) and the LED-MC (U29) shows "00" in the display. Push the press switch (S2) and the number 1 shows and the speaker sounds. Every time you press S2 the number increases by 1.



Project 198

Counting Sound

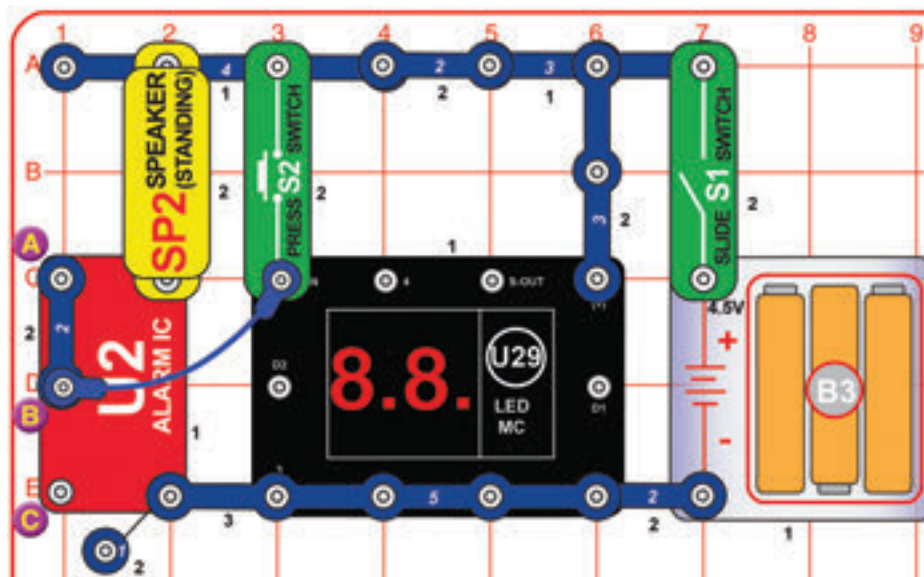

Turn on the slide switch (S1) and push the press switch (S2) several times or hold it down for short periods. A sound plays as the display counts how many times you pressed S2 (holding S2 down makes it count automatically).



Project 199

Another Counting Sound

Move the 2-snap wire from points A & B to points B & C. The sound is different now.



Project 200

Push-Start Disco

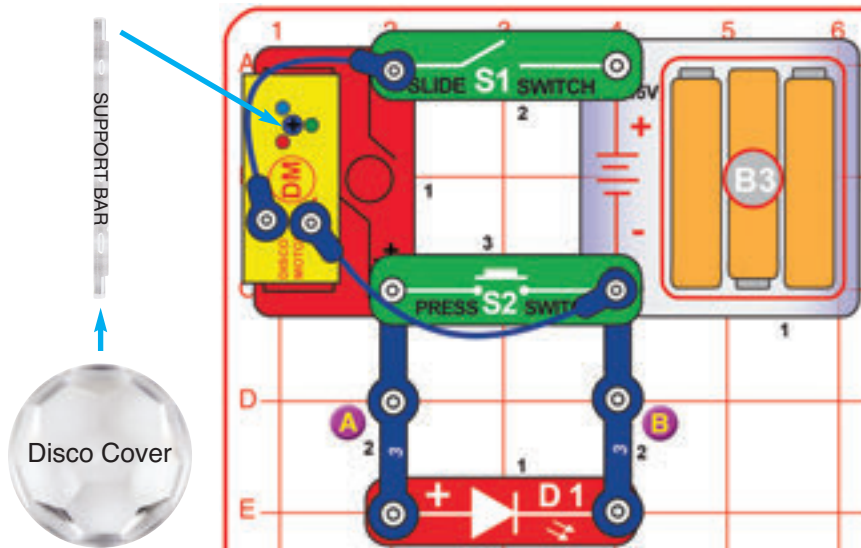

The disco motor needs a lot of power to start up, then less to continue spinning. The red LED (D1) limits the power to the disco motor, usually preventing it from starting up. Pressing S2 bypasses the red LED and gets the disco motor spinning.

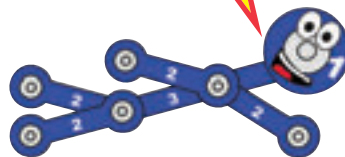

Place one of the disco covers on the disco motor (DM) and turn on the slide switch (S1). The LEDs in the disco motor are on, but the disco cover probably won't move. Push the press switch (S2) and the disco cover spins, and keeps spinning after you release S2. The light patterns are best in a dark room.

Compare the patterns when the disco is spinning fast (with S2 pressed) and slow (S2 released). Try both disco covers, and try holding the circuit at an angle near a wall.

If the motor does not continue spinning after you released S2 then replace your batteries, or go to the next project.

Project 201

Faster Push-Start Disco

Use the preceding circuit, but add the green LED (D2) across the points marked A & B ("+" side of D2 to point A). Now the disco motor (DM) starts easier and spins faster.

Adding the green LED in parallel with the red LED increases the power to the disco motor, helping it to start and spin faster.

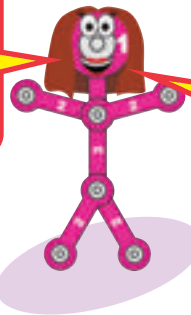

Project 202 Medium Speed Disco

Modify the preceding circuit to match this one. Place one of the disco covers on the disco motor (DM), and turn on the slide switch (S1). Push the press switch (S2) if the disco motor is not spinning.

Compare the patterns when the disco is spinning fast (with S2 pressed) and medium speed (S2 released). The light patterns are best in a dark room. Try both disco covers, and try holding the circuit at an angle near a wall.

Do you see the light from the red, green, and yellow LEDs (D1, D2, & D10) on the ceiling or wall? Try covering them with your hand to see how much they affect what you see.

The red, green, yellow LEDs (D1, D2, & D10) spread their light over a wide angle, to make them easier to see from the sides.

The LEDs in the disco motor concentrate their light, making them much brighter when you look at them directly. They are also brighter due to the quality of their LEDs, and because they are moving.

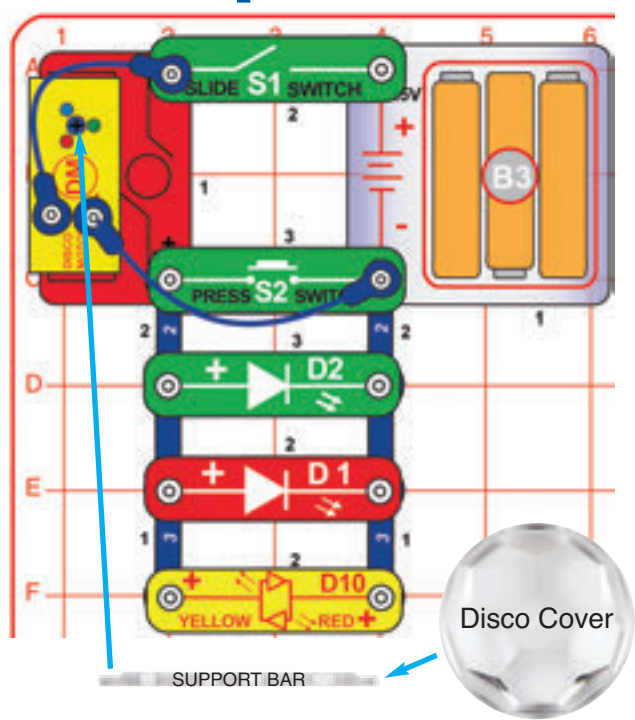



Project 203

Finale

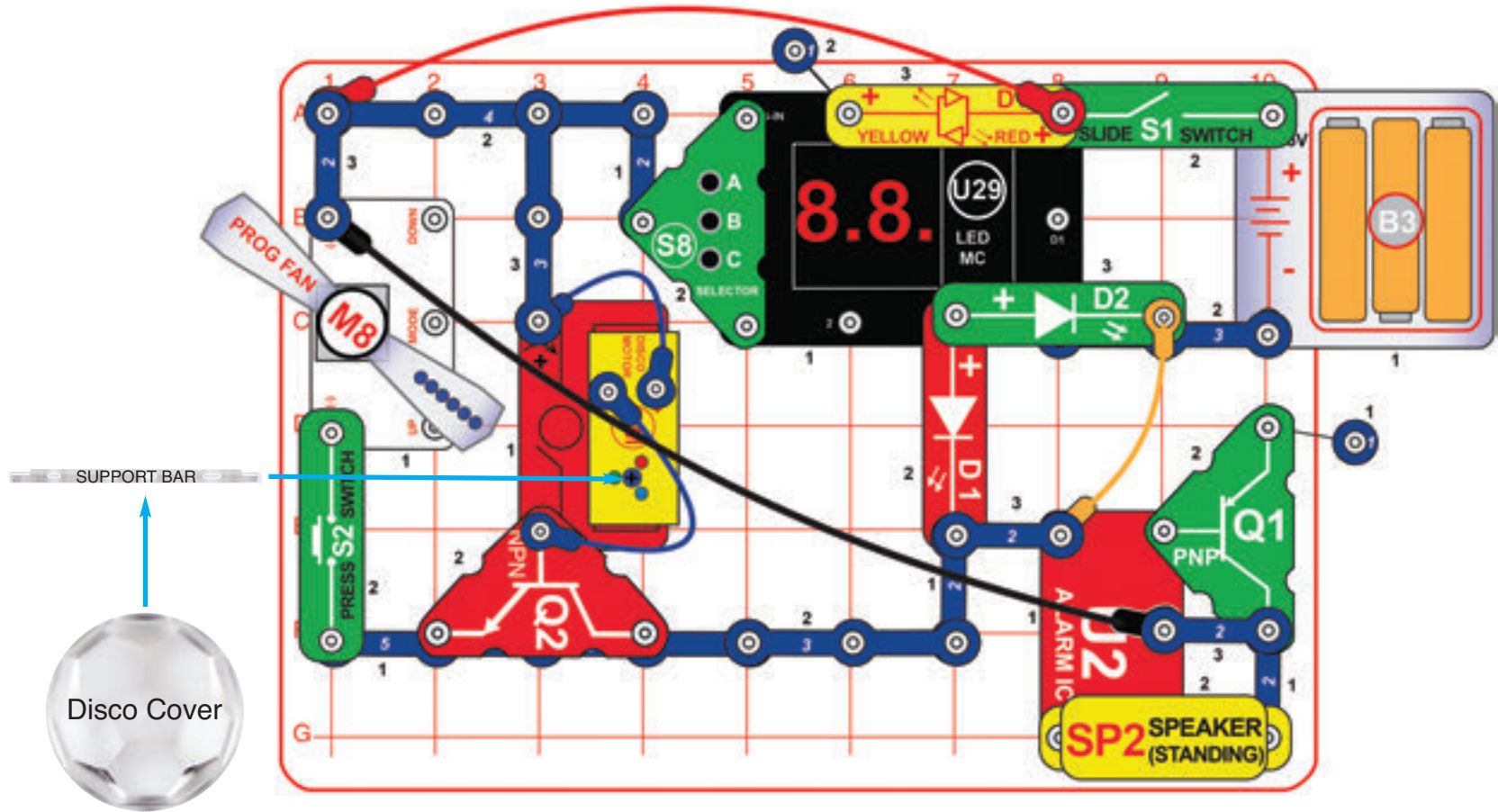

WARNING:
 Moving parts.
 Do not touch the fan while it is spinning.

Build the circuit as shown; note that the 5-snap wire is partially covered by the NPN transistor (Q2), and a 3-snap wire is partially covered by the green LED (D2). Place one of the disco covers on the disco motor (DM).

Turn on the slide switch (S1). A siren sounds, the disco motor spins & lights, and the display on the LED-MC (U29) displays "00". Push and hold down the press switch (S2) to spin the programmable fan (M8); if you hold it down long enough then it cycles through 6 messages.

Make the display on the LED-MC show "02" or "03" by pressing the A button on the selector (S8) to increase the ones digit on the display. Press the B button on the selector. The LEDs (D1, D2, & D10) will flash while the display on U29 displays a random pattern; sometimes they will be rapidly changing, and sometimes they will stop for a few seconds.

This circuit uses all the parts in your set.

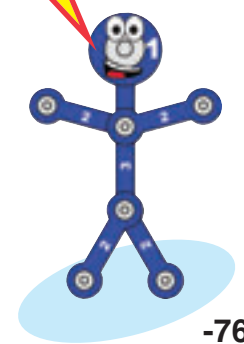

SCA-200 ARCADE Block Layout

Important: If any parts are missing or damaged, **DO NOT RETURN TO RETAILER.**

Call toll-free 284 000 111 or e-mail us at: info@cqe.cz. Customer Service • ConQuest entertainment a.s., Kolbenova 961, 198 00 Praha 9, www.boffin.cz, www.toy.cz. Note: A complete parts list is on page 2 in this manual.

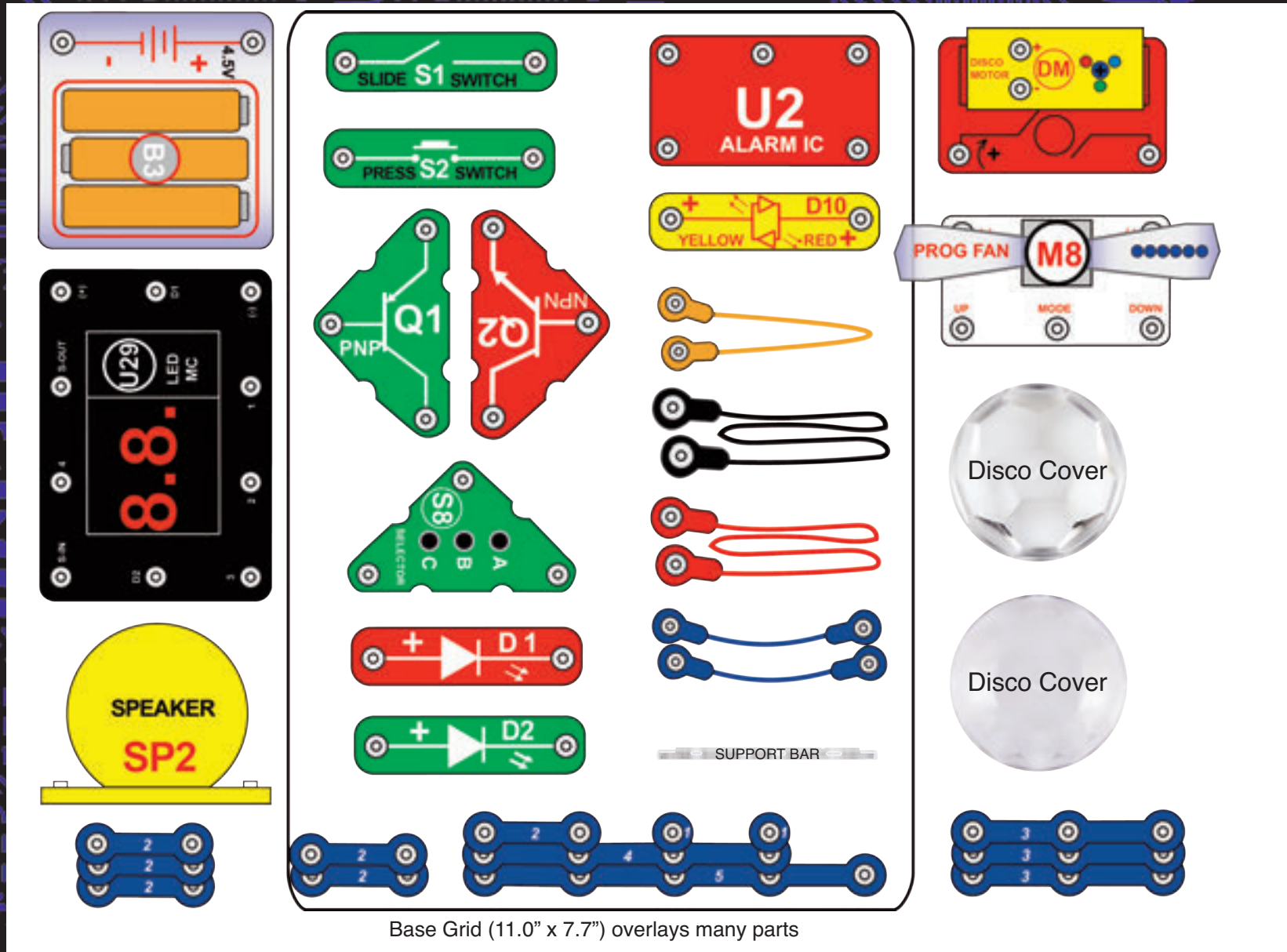

Base Grid (11.0" x 7.7") overlays many parts

The word "BOFFIN" is written in white, bold, uppercase letters inside a blue rounded rectangle with a white border. The background of the entire image is a light gray pattern of circuit board traces.

BOFFIN

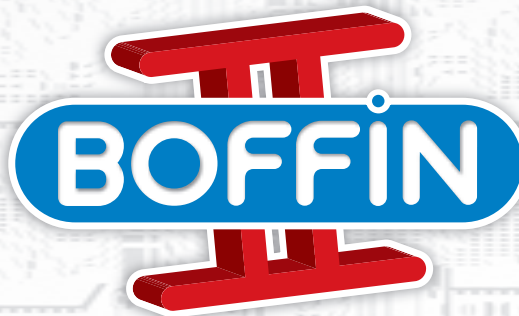

All kits and manuals are available at

www.boffin.cz/en



WWW.TOY.CZ

ConQuest entertainment a.s.

Kolbenova 961, 198 00 Praha 9

www.boffin.cz

info@boffin.cz