



## Flash frequency



**WARNING:** This toy produces flashes that may trigger epilepsy in sensitised individuals.

Only for use by children aged 8 years and older. Not suitable for children and under 8 years due to small parts which could cause a choking hazard.

## Light bulb warning



**WARNING!** Hot surface, do not touch bulb.



**34**  
PROJECTS

**60**  
PARTS



## Overview: Amendments of the new EN 62115: 2020/A11:2020 concerning batteries and LEDs

### Batteries

#### Small batteries

Batteries that fit wholly within the small parts cylinder (as specified in §8.2 of EN 71-1:2014+A1:2018) shall not be removable without the aid of a tool.

For parts of electric toys containing batteries, where the part fits wholly within the small parts cylinder (as specified in 8.2 of EN 71-1:2014+A1:2018), batteries shall not be accessible without the aid of a tool.

#### Other batteries

Batteries shall not be removable without the aid of a tool unless the security of the battery compartment cover is adequate.

Compliance is checked by inspection and by the following test. An attempt is made to gain access to the battery compartment by manual means. It shall not be possible to open the cover unless at least two independent movements have to be applied simultaneously.

The electric toy is placed on a horizontal steel surface.

A cylindrical metallic mass of 1 kg, having a diameter of 80 mm, is dropped from a height of 100 mm so that its flat face falls onto the electric toy. The test is carried out once with the cylindrical metallic mass striking the electric toy in the most unfavourable place. The battery compartment shall not become open.

- ▶ So all batteries need a battery cover in future, which complies with the specifications above.

### Batteries supplied with the toy

Primary batteries supplied with electric toys shall comply with the relevant parts of the IEC 60086 series.

- ▶ A Pass Test Report is needed.

Secondary batteries supplied with electric toys shall comply with IEC 62133.

- ▶ A Pass Test Report is needed.

### Battery compartment fasteners

If screws or similar fasteners are used to secure a door or cover providing access to the battery compartment, the screw or similar fastener shall be captive to ensure that they remain with the door, cover or equipment.

Compliance is checked by inspection and by the following test after the battery door or cover is opened. A force of 20N is applied to the screw or similar fastener without jerks for a duration of 10s in any direction.

The screw or similar fastener shall not become separated from the door, cover or equipment.

### Light-emitting diodes

The emission from electric toys incorporating LEDs shall not exceed the following limits:

- 0,01 Wm<sup>-2</sup> when assessed at 10 mm from the LED front for accessible emissions with wavelengths of < 315 nm;
- 0,01 Wsr<sup>-1</sup> or 0,25 Wm<sup>-2</sup> when assessed at 200 mm, for accessible emissions with wavelengths of 315 nm ≤ λ < 400 nm;

- 0,04 Wsr<sup>-1</sup> or the AEL specified in Tables E.2 or E.3 assessed at 200 mm for accessible emissions with wavelengths of 400 nm ≤ λ < 780 nm;
- 0,64 Wsr<sup>-1</sup> or 16 Wm<sup>-2</sup> when assessed at 200 mm for accessible emissions with wavelengths of 780 nm ≤ λ < 1 000 nm;
- 0,32 Wsr<sup>-1</sup> or 8 Wm<sup>-2</sup> when assessed at 200 mm for accessible emissions with wavelengths of 1 000 nm ≤ λ < 3 000 nm.

### LED data sheets

As the technical data sheet is essential for compliance with this standard, it shall be developed following the measurement criteria of condition A or condition B of CIE 127. The technical data sheet shall indicate that it has been created using the CIE 127 measurement methods and as a minimum include:

- the luminous intensity in candela or radiant intensity in Watts per steradian as a function of forward current,
- the angle,
- the peak wavelength,
- the spectral emission bandwidth,
- the date of issue and the revision number.

- ▶ So all LEDs need a LED data sheet in future, which includes the specifications above.



**WARNING: SHOCK HAZARD** - Never connect Boffin to the electrical outlets in your home in any way.

**WARNING: CHOKING HAZARD** - Small parts. Not for children under 3 years.

**CAUTION:** The lamp (L4) has a very warm lamp enclosure.

**IMPORTANT:** Always check your wiring before turning on a circuit. Never leave a circuit unattended while the batteries are installed. Never connect additional batteries or any other power sources to your circuits. Discard any cracked or broken parts.

Conforms to all applicable government requirements.

Not responsible for typographical errors.

## 🏠 Table of Contents

INTRODUCTION TO ELECTRICITY	3-6
ELECTRICITY IN OUR WORLD	7-8
AS ELECTRICITY ENTERS YOUR HOME	9-11
Project Listings	
Projects 1 - 34	12
How To Use Your Boffin	13-50
Parts List	51-53
About Your Boffin Parts	54
DO's and DON'Ts of Building Circuits	55-57
Troubleshooting	58
Notes	59-60
SC- MyH7 Parts Layout	61
	62

**A Note to Parents and Adults:**

Because children's abilities vary so much, even with age groups, adults should exercise discretion as to which experiments are suitable and safe (the instructions should enable supervising adults to establish the experiment's suitability for the child). Make sure your child reads and follows all of the relevant instructions and safety procedures, and keeps them at hand for reference.

This product is intended for use by adults and children who have attained sufficient maturity to read and follow directions and warnings.

Never modify your parts, as doing so may disable important safety features in them, and could put your child at risk of injury.



# INTRODUCTION TO ELECTRICITY

How do you turn on your light or your television or anything else that requires power in your home<sup>1</sup>? You flip a switch, right? And if the switch doesn't work, what do you do?

**You check to see if it's plugged in.**

Anything that requires power (or charging) in your home must be 'plugged in' to the wiring inside the walls of your house or your building. The wiring inside your house is connected to the power cables on your street. And the power cables on your street are connected to the power lines that travel through your community and, eventually, back to the power plant.



**Nobody really knows what electricity is.**

We just know that it is associated with the movement of subatomic charged particles called **electrons**. Just as water is made up of bazillions of tiny water droplets, electricity is made up of bazillions of tiny **electrons**.

**These electrons flow through metal wires the same way water flows through pipes.**

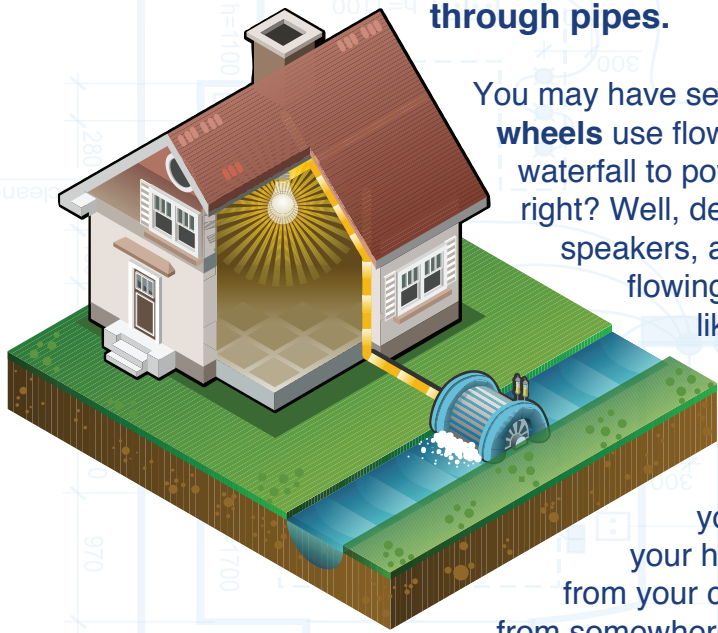

You may have seen how **water wheels** use flowing water or a waterfall to power machines, right? Well, devices like motors, speakers, and light bulbs use flowing electrons to do things like move cars, play music, and make light. The water that comes out of your faucets has to come from somewhere. That water is pumped through pipes from your city's water storage facilities or, if you live in the country, from your well outside. In the same way, the electricity in your house or building is pumped through wires or cables from your city's power stations. That electricity has to come from somewhere too.

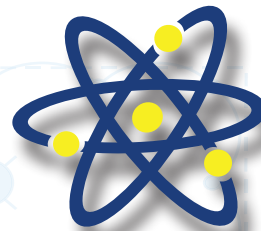

**Your world is powered by electricity.**

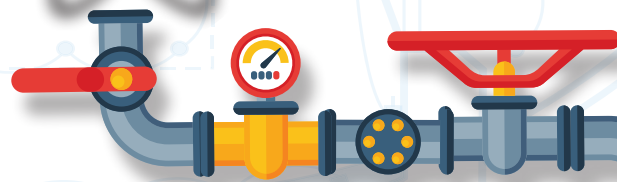

**Valves and faucets** control the flow of water throughout your home and into appliances like your **washing machine** and refrigerator. Switches and transistors control the flow of electricity throughout your home and into appliances like lamps and fans. Turning a switch off blocks the passage of electricity the way that turning a faucet off blocks the passage of water.



Like **water**, electricity must flow in one direction in order to do its work. It has to get from the power station to your house, and on to the next house and the buildings thereafter. The power station only pumps electricity in one direction, so you have no choice in the matter.

You just plug into a power outlet, and you're ready to go. It's not so easy with portable power sources like **batteries**. Fortunately, batteries have (+) and (-) signs to show you which direction they pump their electricity. This is why you have to put your battery in 'the right way', taking care that the (+) side of the battery is in the (+) side of the battery holder, in order for it to work.

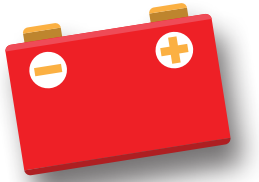

The amount of pressure (or push) a pump puts on the water inside a pipe is measured in **PSI (pounds per square inch)**. The amount of pressure a battery (or other power source) puts on the electrons inside a wire is measured in V (volts) and is called the **voltage**.

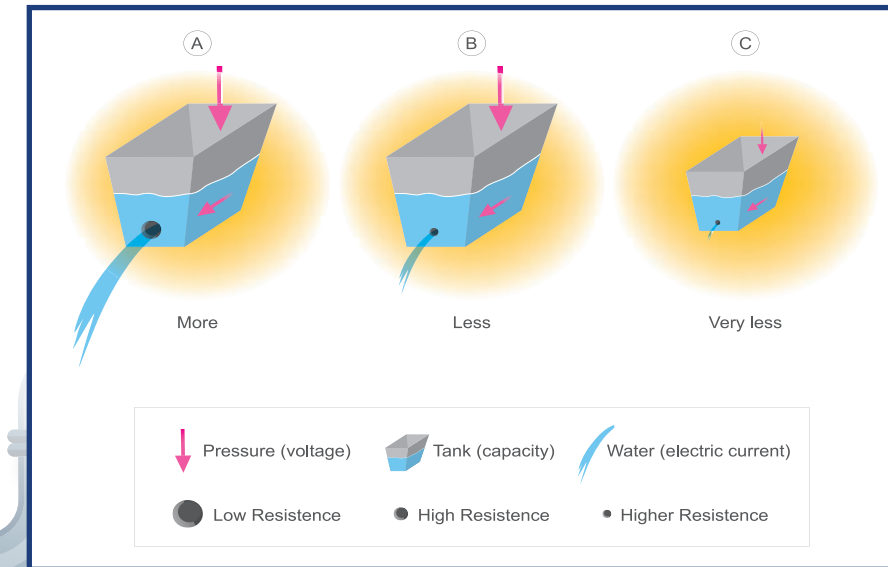

The speed that water flows in the ocean or through a pipe is called its **current**. **Electrical current** (measured in amperes (A) or milliamps (mA, 1/1000 of an ampere)) is the speed that electricity flows through a wire. In either case, the faster the speed, the higher the current. Any electric current measurements you make with this set will be in milliamps.



<sup>1</sup>In this manual, sometimes we say "house" or "building" or "home". Whether you live in a city skyscraper, apartment building, townhouse, or farmhouse in the country - it doesn't matter - electricity works the same way!



The power provided by a battery (or other power source) is the amount of work that its stream of electricity can do at any given moment.

A harder stream of water will get more dirt off your car, right? This is because a hard stream of water has more power than a weak stream. Batteries that produce harder streams of electrons have more power too. And just as the power of an ocean wave is a combination of its size and speed, the power of an electrical source is a combination of its voltage and the current it can provide. The mathematical relationship is **Power = Voltage x Current**, and power is measured in **W or watts**.

In order to flow, electricity needs a complete circuit of conducting wire.

This means it **must** have a continuous wire pathway from the (+) side of the battery (or power station) to the (-) side of the battery (or power station). We can place components (like a light bulb, motor, or appliance) in the path of the electricity and they will slow the electricity down, but they will not stop it. Only a break in the main transmission line (called a circuit break) can do that.

The **resistance** of an electrical component or circuit indicates how much it **resists** the electrical pressure (voltage) by blocking the flow of electrons. The larger the blockage in a clogged pipe, the more slowly water flows through it, right? In the same way, electricity flows more slowly through components with higher resistances (measured in ohms,  $\Omega$ ). Sometimes we place special components called **resistors** in a wire pathway for the sole purpose of slowing down the electrons flowing through it.

The current, voltage, and resistance of an electrical system are all related to one another through this simple mathematical equation:

**Voltage = Current x Resistance.**

**This equation is very important in electronics.**

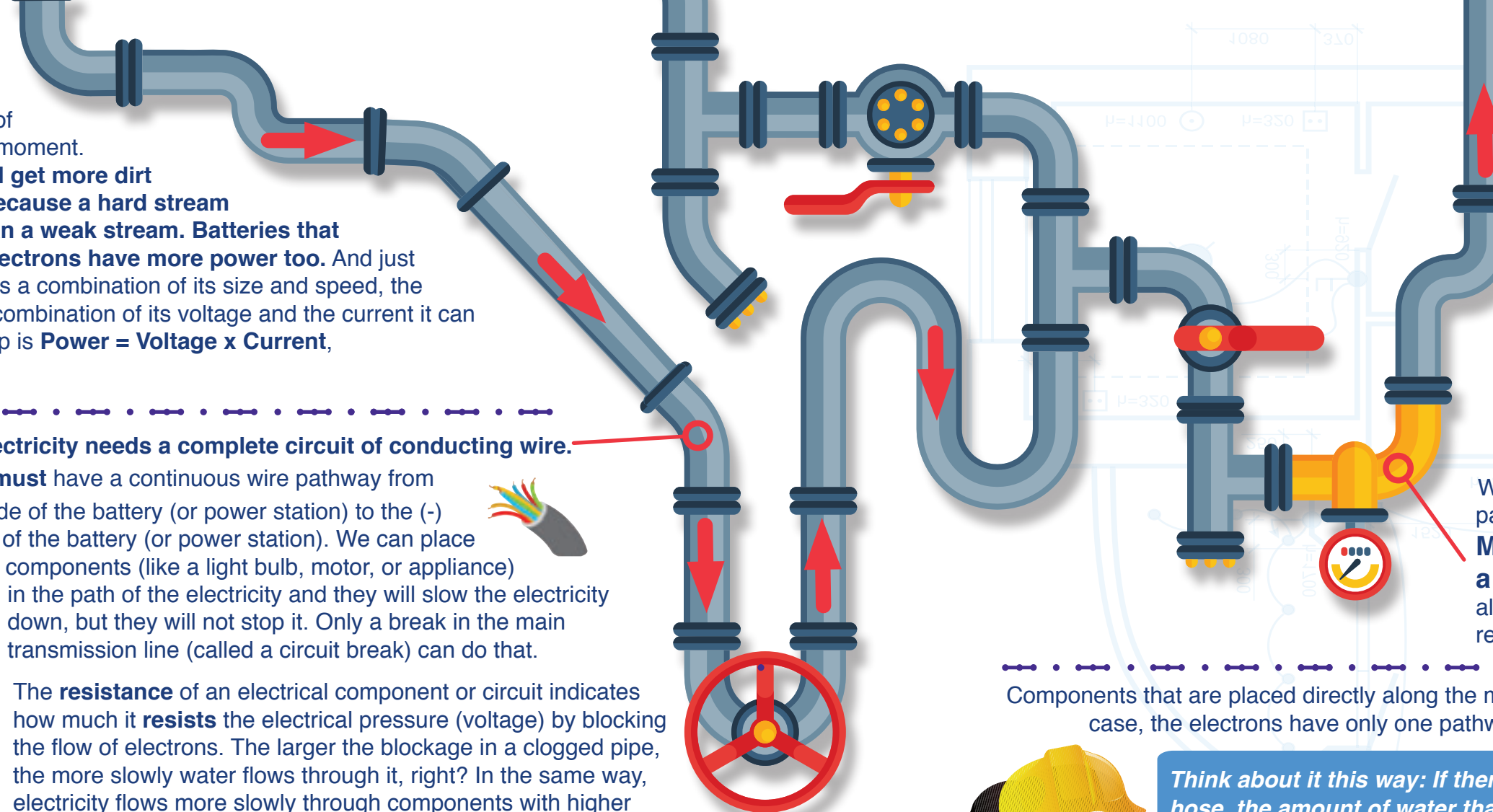

The voltage of the power source is a constant value - it's printed on every battery. So if the resistance goes up, the current must go down, and vice versa (if the resistance decreases, the current must increase accordingly).

As long as there are no breaks in its wire path, electricity can take side tracks along its main transmission line from the (-) to the (+) side of its power source, providing electricity to appliances, homes, and whole towns. When components are placed along these side tracks, we say they are in **parallel** to the main transmission line.

When multiple components are placed in **parallel**, the electrons are given as many paths to follow as there are parallel components. **More water flows more quickly through a partially blocked pipe than a nearly clogged one, right?** In the same way, more electrons flow more quickly along the pathway with the least resistance. For components in parallel, the lowest resistance dominates.

Components that are placed directly along the main transmission line are said to be in series. In this case, the electrons have only one pathway from the (-) to the (+) side of the power source.

*Think about it this way: If there are three small blockages in one garden hose, the amount of water that comes out will be determined by the worst blockage, right? Same thing with electricity.*

The flow of electrons through multiple components in series will slow down the most when they travel through the component with the highest resistance. For components in **series**, the largest resistance dominates.

Components can be arranged in series in any order and still have the same combined effect on the electricity flowing through them. Same thing goes for components arranged in parallel. In this way, we combine smaller 'integrated' circuits to produce the large and complicated circuits that power our cell phones, our computers, and our entire world.

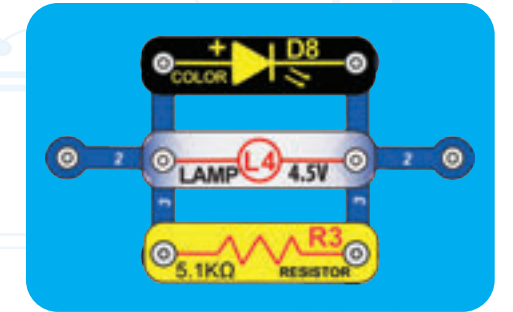

Example of a Parallel Circuit

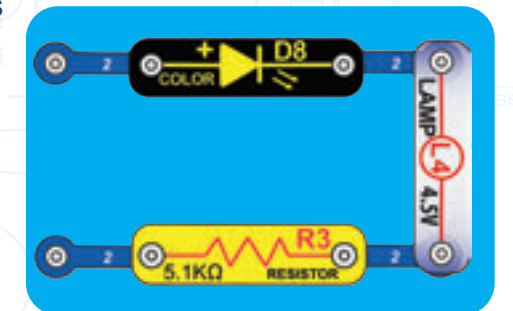

Example of a Series Circuit

# ELECTRICITY IN OUR WORLD

A small amount of the electricity we use comes from the chemical energy in batteries (like the **AA batteries** in your B3 battery holder), but **most of the electricity used in our world is produced at enormous steam or water pressure, or (increasingly) by wind or solar.**

## Fossil fuels (coal/oil/natural gas)

or nuclear fuels are burned/consumed to produce high-pressure steam that drives electric generators. Dams create high water pressure that drives electric generators.

**Windmills use wind to drive electric generators.**

**Large arrays of solar cells produce electricity.**

**Wires are used to efficiently transport this energy to homes**

**and businesses where it is used.** Once there, motors inside our appliances (the ones that are plugged in and turned on) turn that electricity back into the mechanical motion required to make these appliances work. The most important aspect of electricity in our society - more important than the benefits of the Internet - is that it allows energy to be easily transported over distances.

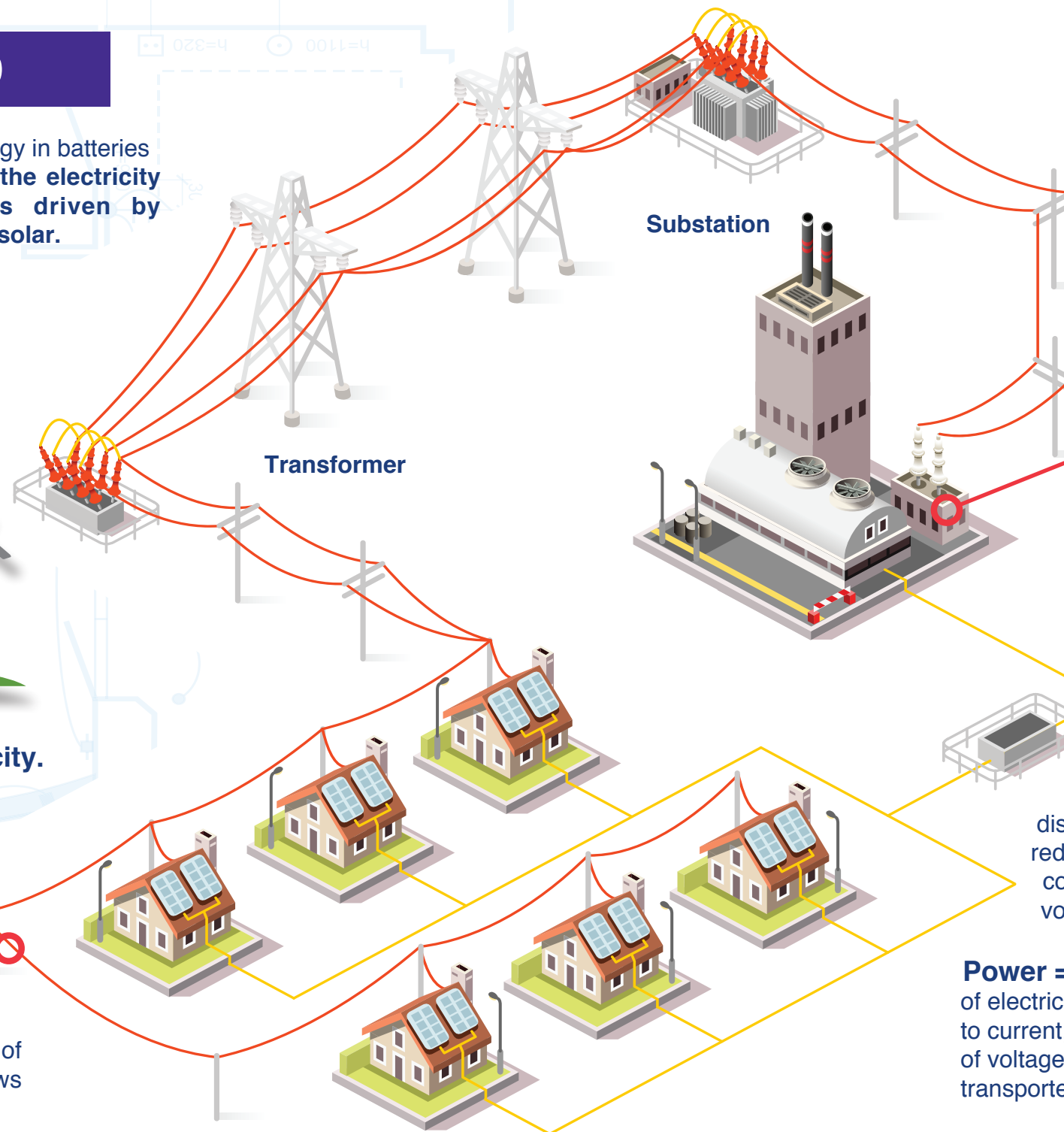

Note that “distances” includes not just large distances but also tiny distances.

Try to imagine a plumbing structure of the same complexity as the circuitry inside a portable radio - it would have to be large because we can't make water pipes so small.

Electricity allows complex designs to be made very small.

**Most electricity produced at large generating stations comes out at very high voltage (sometimes >100,000V).**

**This electricity goes through high-voltage transmission lines poles that stretch across the country.**

When it reaches a **substation**, **transformers** reduce the voltage so it can be sent on smaller power lines. It travels through distribution lines to your neighborhood. Smaller transformers reduce the voltage again to the 120V used in our homes.

Electricity is transported over long distances at high voltage because this reduces the amount lost in transmission, compared to transporting it at lower voltage.

**Power = voltage x current**, and the amount of electricity lost in transmission is proportional to current, so transformers change the ratio of voltage to current to allow electricity to be transported more effectively over long distances.

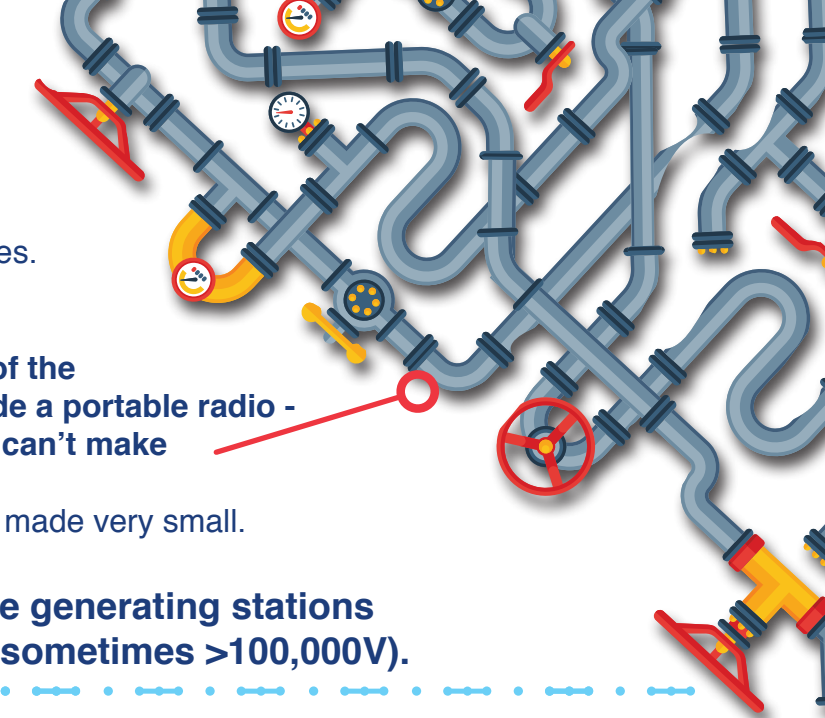

Projects 1-2 will show how electricity can generate motion in a motor, and projects 5-6 will show how motion in a motor can be used to produce electricity.

This concept may not seem important to you but it is actually the foundation of our present society's power.



# AS ELECTRICITY ENTERS YOUR HOME

Before it goes into your house or building, the electricity produced at the power station goes through a meter and is measured by your electric company to determine how much you are using (and how much it will cost you).



Fuses are designed to shut down a circuit when the current **gets too high**. This can happen when a person uses an appliance the wrong way, or when the appliance is designed badly or just malfunctions. When a high current spike passes through a fuse, it causes the fuse to break. With the fuse broken, the metal pathway into your house is also broken (disconnected), so that electricity can no longer flow. This shutdown prevents further damage to the circuit and can prevent explosions or fires. Fuses are important for safety and most electrical products have one.

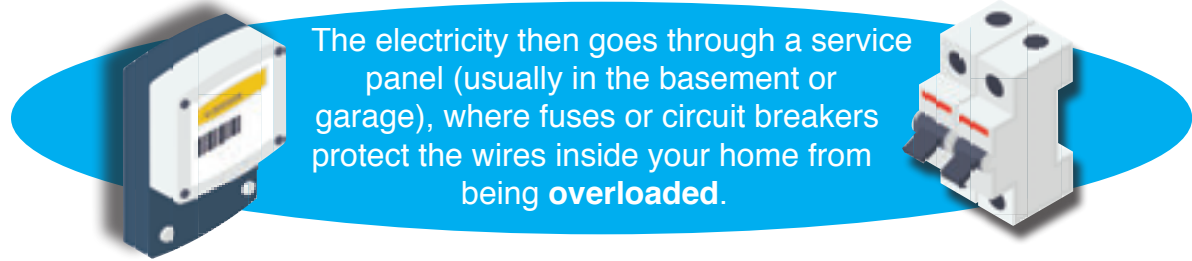

The electricity then goes through a service panel (usually in the basement or garage), where fuses or circuit breakers protect the wires inside your home from being **overloaded**.

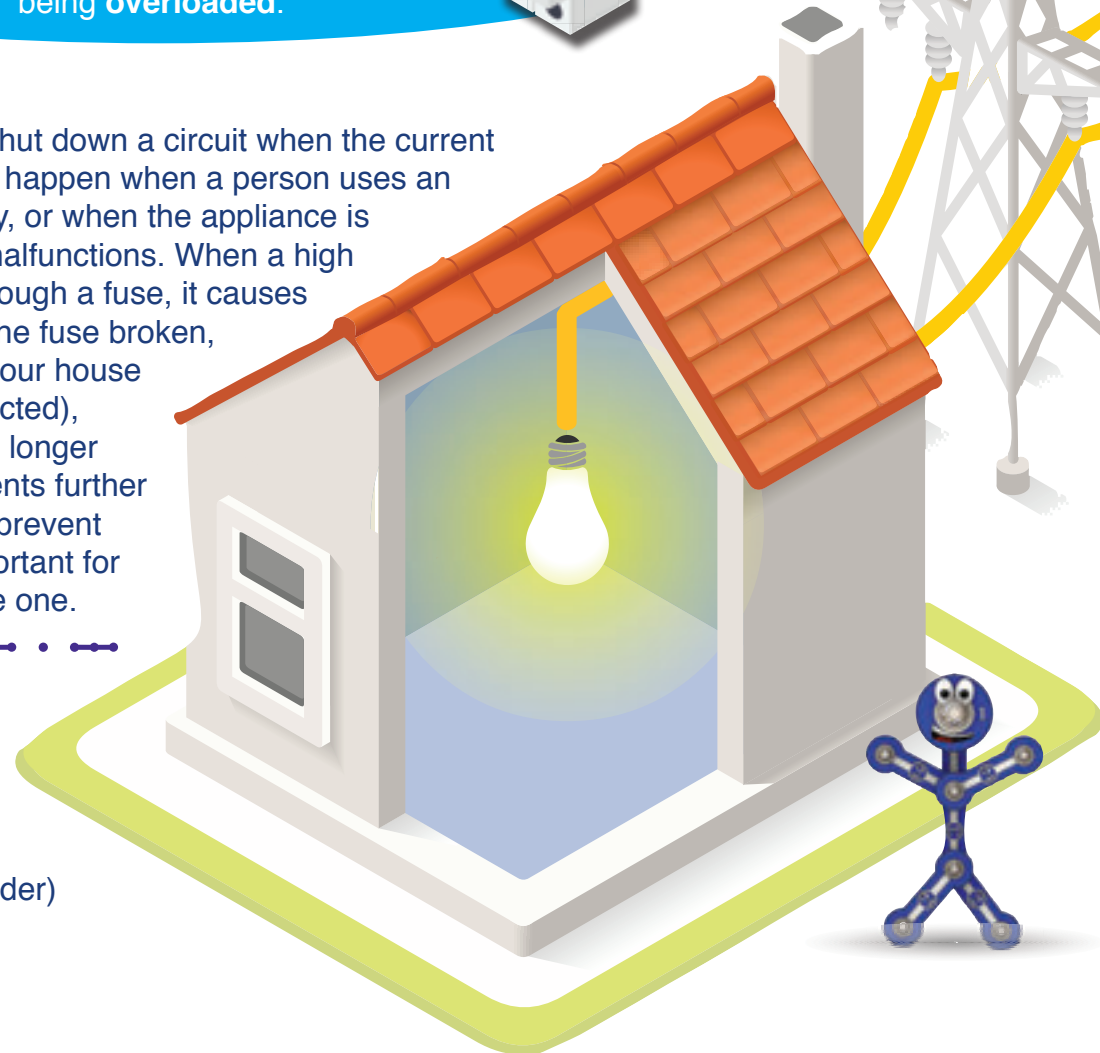

Some fuses need to be replaced after they “blow”, but others can be reset by flipping a **switch**, and some (like the one in your B3 battery holder) can reset automatically.

Fuses in your home’s fuse box are designed to prevent a problem in part of your house from starting a fire or affecting the rest of your house.

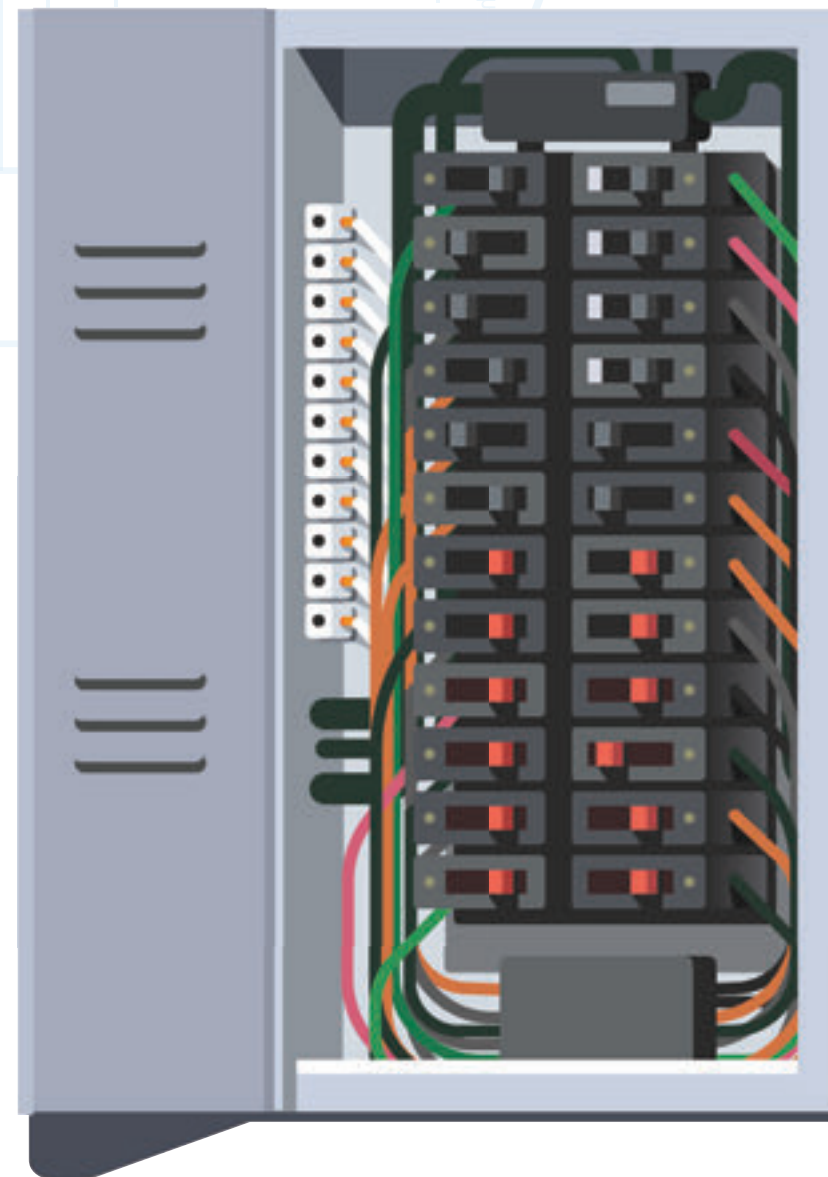

But **fuses** are not designed to protect you directly from getting hurt when you use an electrical appliance in your home because the normal operating power of some appliances is already enough to be dangerous to people.

If lightning hits a transmission line or electrical cable entering your house, it can cause a massive spike of electricity to suddenly pass through the cable and into your home.

So much electricity in such a short space of time can **overload your appliances**, burning out their components or electrical connections, which can cause a fire.

Fortunately, the wires enter your home through a **service panel**, where **fuses and circuit breakers** will block this high-powered electricity from damaging your home and your family.

(Learn more about lightning in Project 34)

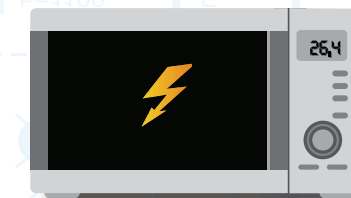

# AS ELECTRICITY ENTERS YOUR HOME



**When lightning (or ice or wind) causes a tree to fall and break a power line**, a gap is created in the line that cuts off electricity to every building along its route. If it is a main transmission line, entire towns and cities can lose power until the line is repaired.

When this happens, it's no use plugging your appliances in and turning them on, the electricity is 'out'. This is when batteries come in handy; and your phone, your car, your video-game controller wouldn't be the same without them.

After successfully passing through the fuses or circuit breakers in your service panel, the electricity travels through wires inside your walls to outlets and switches all over your house. The electrical wiring in **your house** is hidden by plaster and wooden walls, ceilings, and floors and requires a lot of work to install and access when repairs are needed.

Use your electrical appliances according to their instructions in order to ensure the electricity in your house works the way it's intended.

*It's your home and your power, you should know how it works to keep your gadgets going and to stay safe!*



**Thank you** to children's author Melissa Rooney, PhD, for her assistance in writing the Introduction and other sections of this manual. You can find out more about Melissa at [www.melissarooneywriting.com](http://www.melissarooneywriting.com).

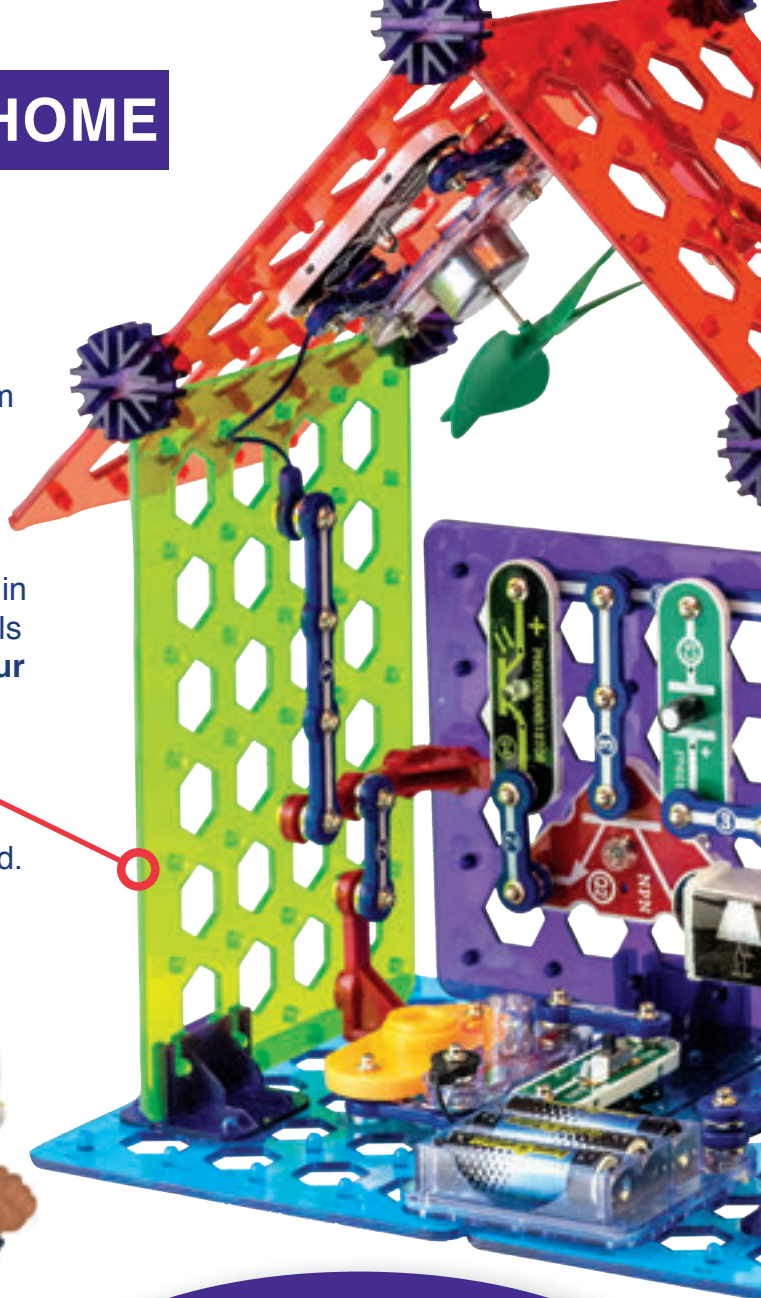

# PROJECT LISTINGS

Project	Description	Page	Project	Description	Page
1	Meet Your Parts	13-14	18	Electric Heater	35
2	Wire Up! Lights Can Share The Same Circuit	15	19	Water Completes Circuit	35
3	Dependent Lights	16	20	Automatic Light	36
4	Independent Lights	17	21	Tree Lighting	36
5	Windmill	17	22	Transistor Amplifier	37
6	Mini-Windmill	18	23	Light & Sound	37
7	Overhead Lights	19-20	24	Audio Fan Speed Adjuster	38
8	Electric Home	21-24	25	Distance Loss Simulator	38
9	Home Security	25-26	26	Light-Controlled Light	39
10	Block the Sound	27	27	Photo Control	39
11	Materials Tester	28	28	Infrared-Controlled Light	40
12	Dim Color Light	28	29	IR Control	40
13	Mini Battery	29	30	2-Story House	41-42
14	Storing Electricity	30	31	3-Wall House	43-44
15	Fader	32	32	High Ceiling House	45-46
16	Timed Wall of Fun	32	33	2-Story Building	47-48
17	Festive House	33-34	34	Static Electricity	49-50

Projects 1-2 demonstrate your parts in simple circuits. Projects 3-4 demonstrate simple circuit arrangements. Projects 5-6 demonstrate using a motor as a generator. Project 7 is a simple 3D circuit construction. Project 8 demonstrates and explains what electricity does in a home. Projects 9-29 are basic circuits and applications. Projects 30-33 are large 3D home circuits. Project 34 demonstrates static electricity.



# Project 1 | MEET YOUR PARTS

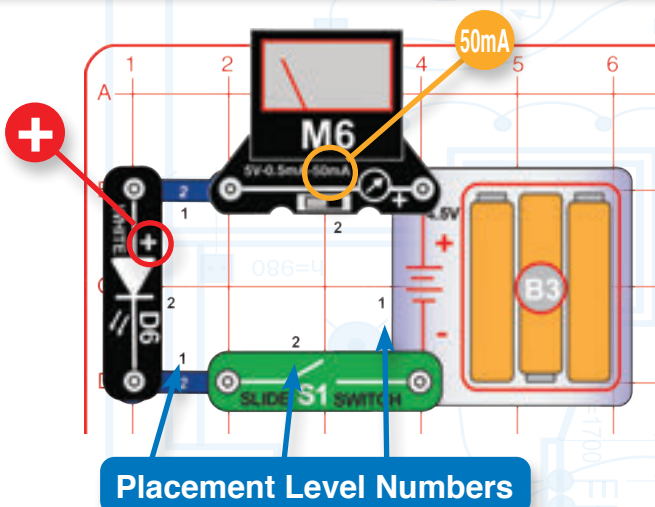

Build the circuit shown on the left by placing all the parts with a black 1 next to them on the base grid first. Then, assemble parts marked with a 2. Install three (3) "AA" batteries (not included) into the battery holder (B3) if you have not done so already. Set the meter (M6) to the 50mA setting.

Turn on the slide switch (S1). The white LED (D6) lights and the meter measures the current.

Boffin uses electronic blocks that snap onto a clear plastic base grid to build different circuits. These blocks have different colors and numbers so you can easily identify them. This set contains five different color base grids, you may use any one to build the circuit.

The circuits in this book often do not use a resistor or other component to slow down the electrical current passing through the LED. Normally this would damage an LED, because LEDs can only handle very low currents (much smaller than the current provided by your battery). But your Boffin LEDs have resistors built into them, and these internal resistors protect the LEDs by slowing down the current. Be careful if you use electrical sets with unprotected LEDs, as you will need to use external resistors to prevent them from burning out.

## WHAT IS REALLY HAPPENING HERE ?

- The batteries (B3) convert chemical energy into electrical energy and "push" it through the circuit, just like the electricity from your power company. A battery pushes electricity through a circuit like a pump (or gravity in the case of a water tower) pushes water through pipes.
- The snap wires (the blue pieces) carry the electricity around the circuit, just like wires carry electricity around your home. Wires carry electricity like pipes carry water.
- The meter (M6) measures how much electricity flows in a circuit, like a water meter measures how fast water flows in a pipe.
- The white LED (D6) converts electrical energy into light, it is similar to a lamp in your home except smaller. LEDs are increasingly being used for home lighting because they are more efficient than other types of bulbs. An LED uses the energy carried by electricity, resisting its flow like a pile of rocks resists the flow of water in a pipe.

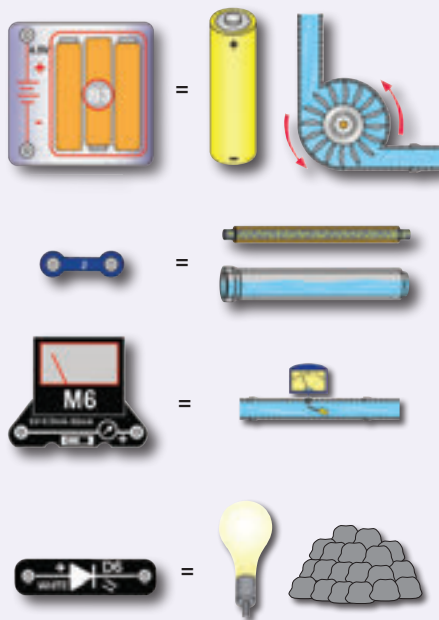

- The slide switch (S1) controls the electricity by turning it on or off, just like a light switch on the wall of your home. A switch controls electricity like a faucet controls water.
- The base grid is a platform for mounting the circuit, just like how wires are mounted in the walls of your home to control the lights.

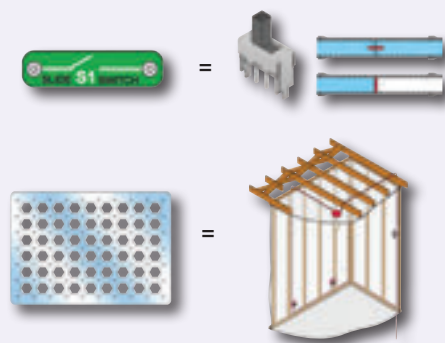

### Comparing Electric Flow to Water Flow:

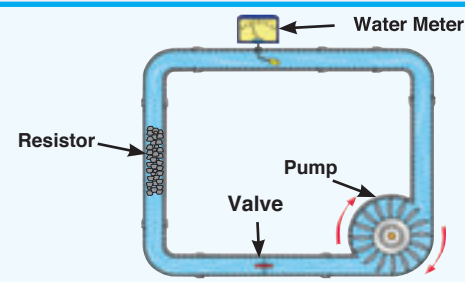

**Part B:** Replace the white LED with the color LED (D8, "+" on top) and enjoy the light show as the meter measures the current. For best effects, dim the room lights.

**Part C:** Replace the color LED with the lamp (L4). The current measured on the meter will be very high and off the scale (you are measuring a 200mA lamp with a 50mA meter). Incandescent light bulbs are much less energy efficient than LEDs. *Do not leave the circuit for two minutes because the lamp will be hot.*

**Part D:** Replace the lamp with the melody IC (U32, "+" on top) and listen to the sound as the meter measures the current.

**Part E:** Replace the melody IC with the motor (M4) and green fan and see the fan spin as the meter measures the current. Reverse the orientation of the motor to make the fan spin in the opposite direction (this changes whether the fan blows air up or down).

**Part F:** Replace the motor with the phototransistor (Q4, "+" on top) and vary the amount of light shining on it. The current measured on the meter varies from near zero when you cover the phototransistor to high when you shine a flashlight directly on it.

**Part G:** Replace the phototransistor with the 5.1kΩ resistor (R3) and see the current on the meter. The current will be very low, but you can change the meter to the 0.5mA setting to confirm that some current is flowing.

LEDs are light emitting diodes, which convert electrical energy into light. The color of light from an LED depends on the characteristics of the material used in it. The color LED actually contains separate red, green, and blue lights, with a micro-circuit controlling them.



The lamp (L4) converts electricity into light. It is an incandescent light bulb, just like other incandescent bulbs in homes except smaller. In an incandescent bulb electricity heats up a high-resistance wire until it glows, producing light. Incandescent light bulbs are very inefficient, converting less than 5% of the electricity used into light, with the rest becoming heat. LEDs are much more efficient than incandescent light bulbs, and are increasingly being used for home lighting and flashlights.



The melody IC makes an electrical pattern from tunes recorded in its memory. A speaker inside it then converts the electrical pattern into sound by making mechanical vibrations. These vibrations create variations in air pressure which travel across the room. You "hear" when your ears feel these air pressure variations.



The motor uses magnetism to convert electricity into mechanical motion (see page 57 [About Your Parts] for more explanation).



The phototransistor is a material whose electrical resistance varies depending on the amount of light shining on it.



A resistor "resists" or slows down the flow of electricity. Resistors are used to limit or control electricity in a circuit.



To learn more go to pages 55-57.



## Project 2 | WIRE UP! LIGHTS CAN SHARE THE SAME CIRCUIT

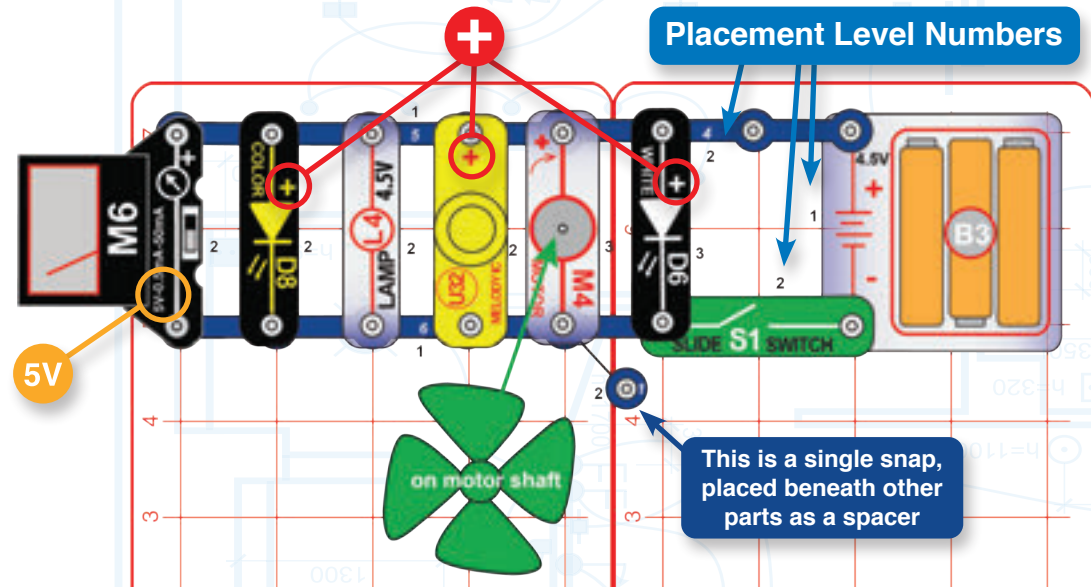

Build the circuit shown. Set the meter (M6) to the 5V setting. If desired, place the fiber optic festive tree in its mounting base and on the color LED (D8). Turn on the slide switch (S1) and enjoy the show.

The meter measures the voltage from the batteries - this may be 4.5V if your batteries are new, but will likely be less because the circuit components are a heavy load on the batteries. Try removing the lamp, motor, melody IC, and LEDs, one at a time and see how the measured voltage changes. *Do not leave the circuit for two minutes because the lamp will be hot.*

The battery voltage (electrical pressure) may drop as the current increases, because the batteries may not be able to supply all the current the circuit needs. This effect is more noticeable when the batteries are weaker. The lamp needs much more current than the other components, so it has the greatest effect on the battery voltage.

A "brownout" occurs when power plants cannot supply enough current to a city during high demand, and must reduce the voltage they supply. This sometimes occurs on hot days in summer when everyone is using their air conditioners.

**Note:** base grid colors are interchangeable, so use any color you like.

## Project 3 | DEPENDENT LIGHTS

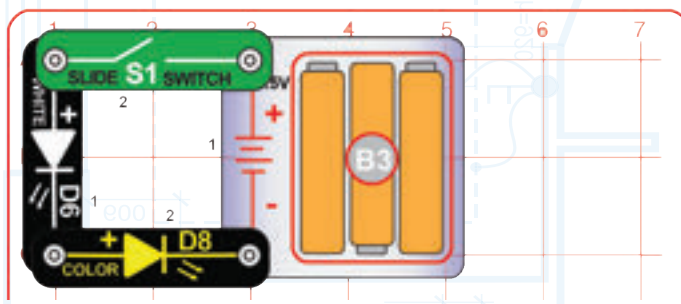

Build the circuit and turn on the slide switch (S1). The white and color LEDs (D6 & D8) should be blinking but may be dim. If neither lights at all then replace your batteries.

The two LEDs are connected in a series, and all the electric current from the batteries flows through each component in the circuit. The LEDs are dim because the voltage from the batteries (B3) is divided between them.

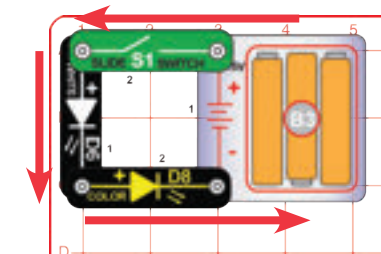

Connecting parts in series is one way of arranging them in a circuit. The advantage of it is that wiring them together is simple. The disadvantage is that if one LED breaks, all will be off.

This circuit has both LEDs connected in **SERIES**. Series circuits are simple to connect, and allow one component to easily control another (here the white LED blinking is controlled by the color LED's blinking). The LEDs may be dim because the battery voltage may not be high enough to make both bright. **If one LED breaks, then the circuit is broken and neither will work.**

The slide switch (S1) is also connected in series with the LEDs, so it can turn them on and off.

## Project 4 | INDEPENDENT LIGHTS

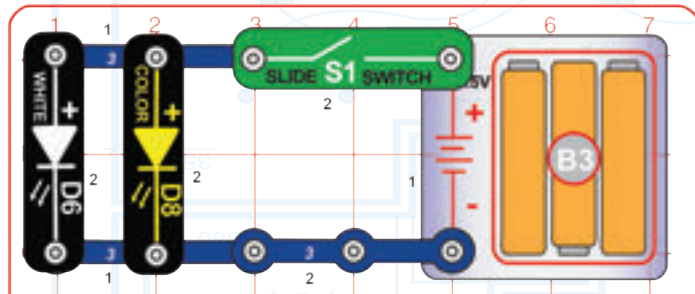

Build the circuit and turn on the slide switch (S1). The white and color LEDs (D6 & D8) are bright now and only the color LED is blinking.



Compare this circuit to the preceding circuit. This circuit has both LEDs connected in PARALLEL. Parallel circuits make components independent of each other but require more complex wiring (notice how this circuit requires more parts than the preceding circuit). Both LEDs are bright because each gets the full battery voltage, but they will drain the batteries faster. If one LED breaks then the other will still work.

In this circuit the batteries produce an electric current, which flows through the switch, then divides between the 2 LEDs, then re-combines and flows back into the batteries.

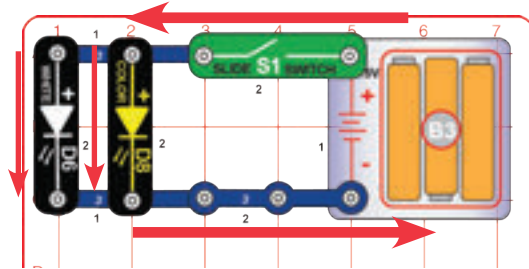

The two LEDs are connected in parallel with one another. They are bright because each LED gets the full battery voltage. Most of the lights in your house are connected in parallel; so if one bulb burns out then the others are not affected.

## Project 6 | MINI-WINDMILL

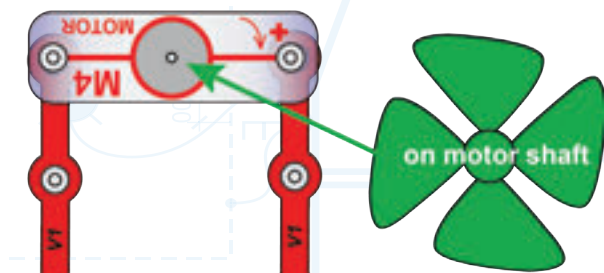

Change the preceding circuit into this one. Now blow on the fan to simulate wind. If you blow hard enough, the color LED (D8) lights up. Is it easier to light the LED in this circuit or the previous circuit?

## Project 5 | WINDMILL

### Assembly:

1. Place base grid supports on base grid B.
2. Place parts on grid A, and install into base grid supports on grid B.
3. Install remaining parts on grid B.

Set the meter to the 50mA scale and blow on the fan to simulate a strong wind. You can also set the meter to the 5V scale to measure the voltage produced.

Replace the meter with the color LED ("+" on left). If you blow hard enough then the color LED (D8) will light.

Here the clear motor (M4) is a generator that uses the physical motion of the windmill to pump electricity through the circuit. The motors in commercial windmills are much more efficient, meaning they generate less heat and waste less electricity. Windmills also use fan blade shapes and materials that lower friction (friction is how hard the wind has to push on the blades to make them move), so they can produce electricity even in light winds.

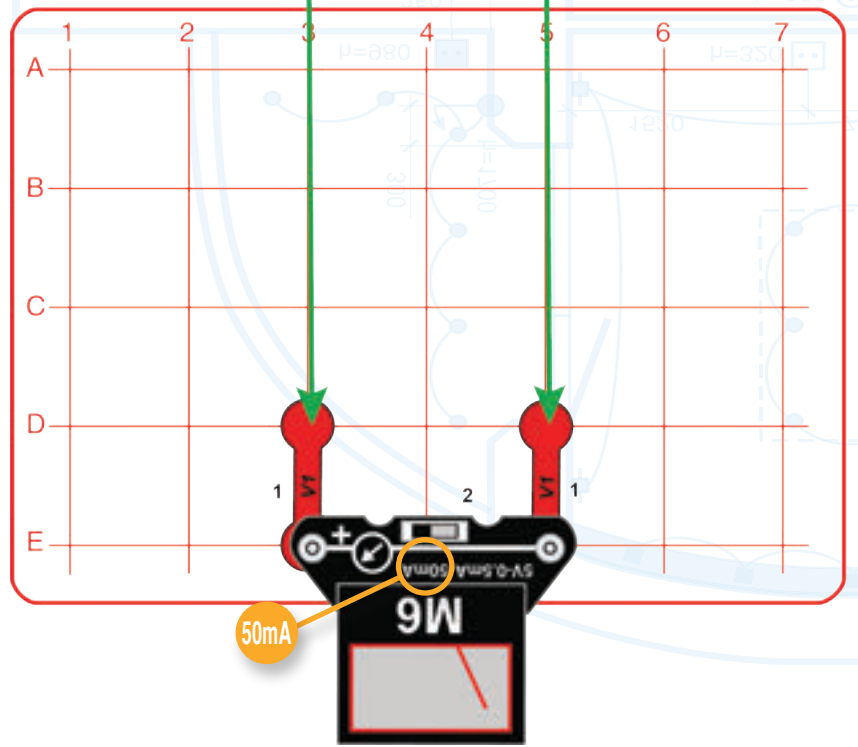
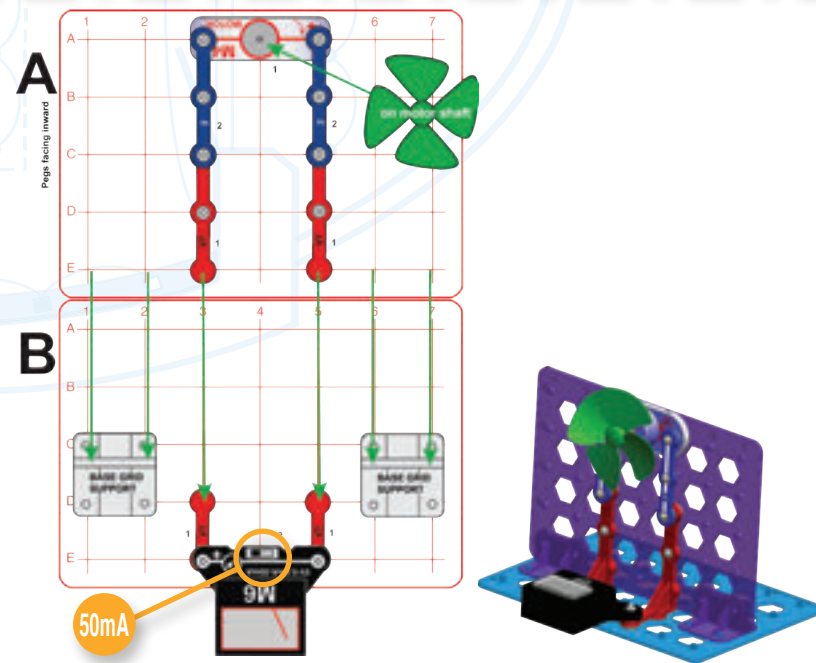

This circuit improves the air flow by removing the base grid from behind the fan, but it is not as physically stable and comes apart more easily.



# Project 7 | OVERHEAD LIGHTS

Think of this circuit as a room with an overhead light. Electricity flows from the batteries on the floor to the white LED on the ceiling, down to the slide switch on the other wall, and then back to the batteries. The batteries represent the power supplied by your local electric company. The white LED is a ceiling light. The slide switch is the switch on your wall that turns the ceiling light on or off. And the blue snap wires are the wires in the walls of your house. The colored base grids are just the structure of your house.



**Note: Base grid colors are interchangeable, so use any color you like at any location.**

Side view:

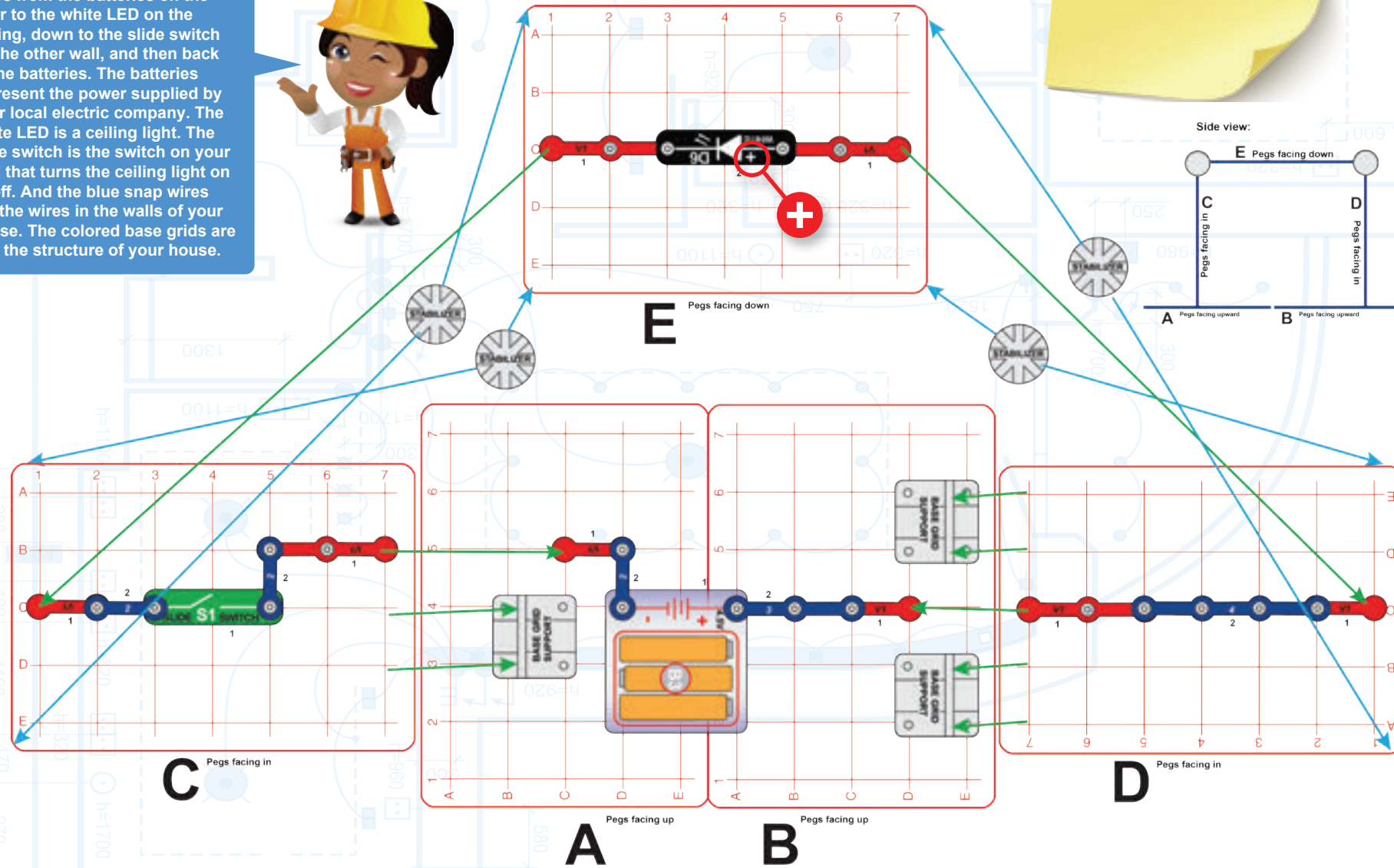
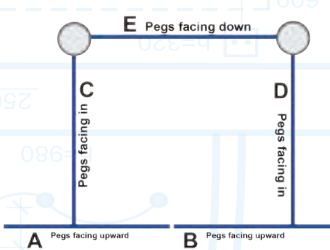

## Assembly (adult supervision recommended):

1. Place base grid supports on base grids A & B.
2. Place parts on base grids C, & D, and install into base grid supports on grids A & B. The pegs should be facing inward. Base grid colors are interchangeable, so you can use any color you like at any location.

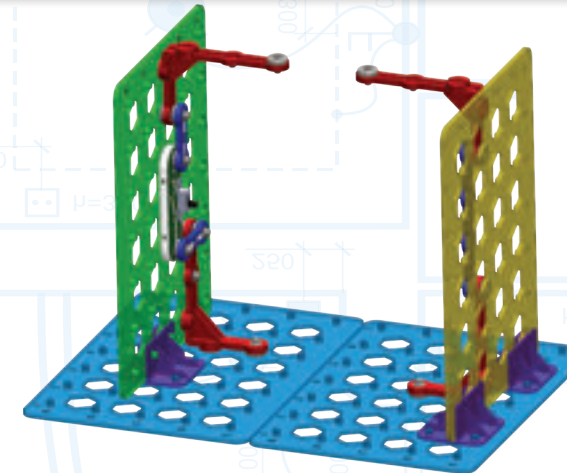

3. Mount grid E on top of grids C & D using 4 stabilizers, attaching the 2 vertical snap wires (V1) as you do it.

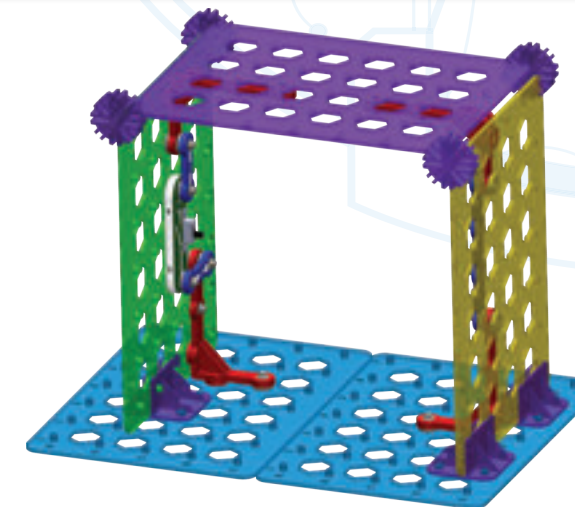

4. Place the remaining parts on grids A, B, & E.

Turn on the slide switch (S1) to light the white LED (D6).

Go to [www.boffin.cz](http://www.boffin.cz) for an interactive 3D picture to help with constructing this circuit.

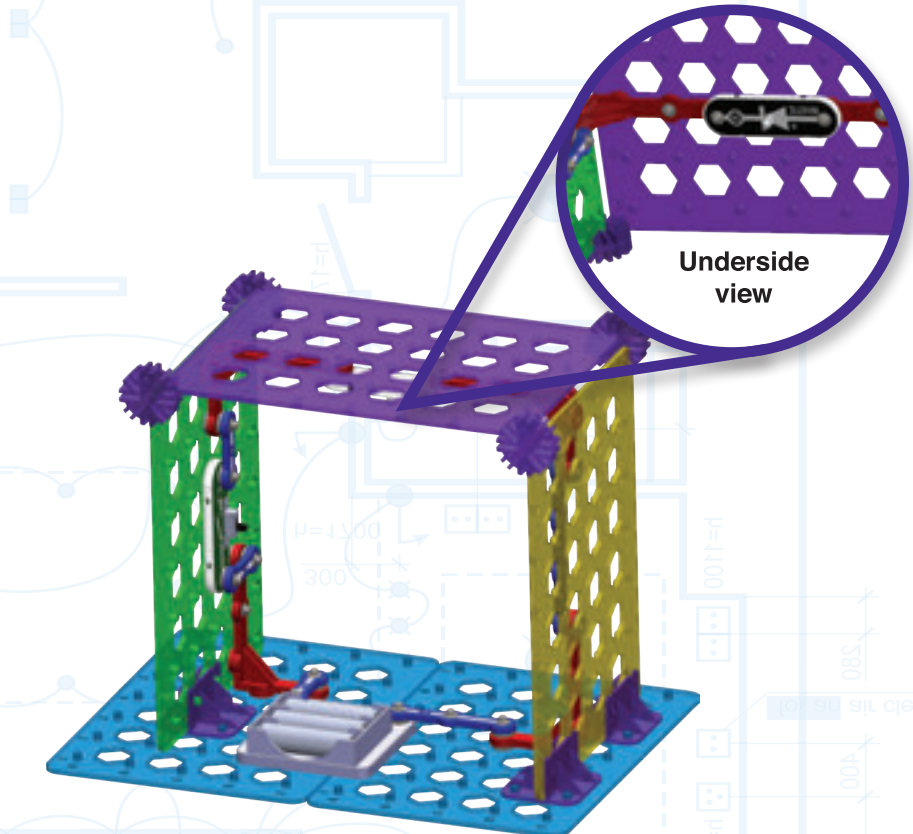

**Part B:** Carefully replace the white LED (D6) with the color LED (D8), or carefully add the color LED next to the white LED as shown here.

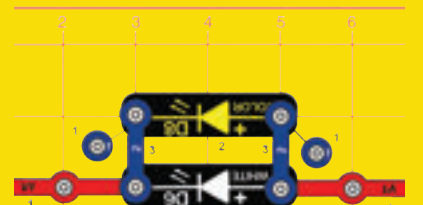

# Project 8 | ELECTRIC HOME

The light covers and slides may be placed on the LEDs (D6 and D8) or lamp (L4) as decoration. Fold the slides as indicated and slide them into the slots on the cover, as shown.



Front-Side view:  
Stabilizers are identified as F1-F4 and B1-B4 (Front 1-4 and Back 1-4), as shown on this drawing.

Side view:

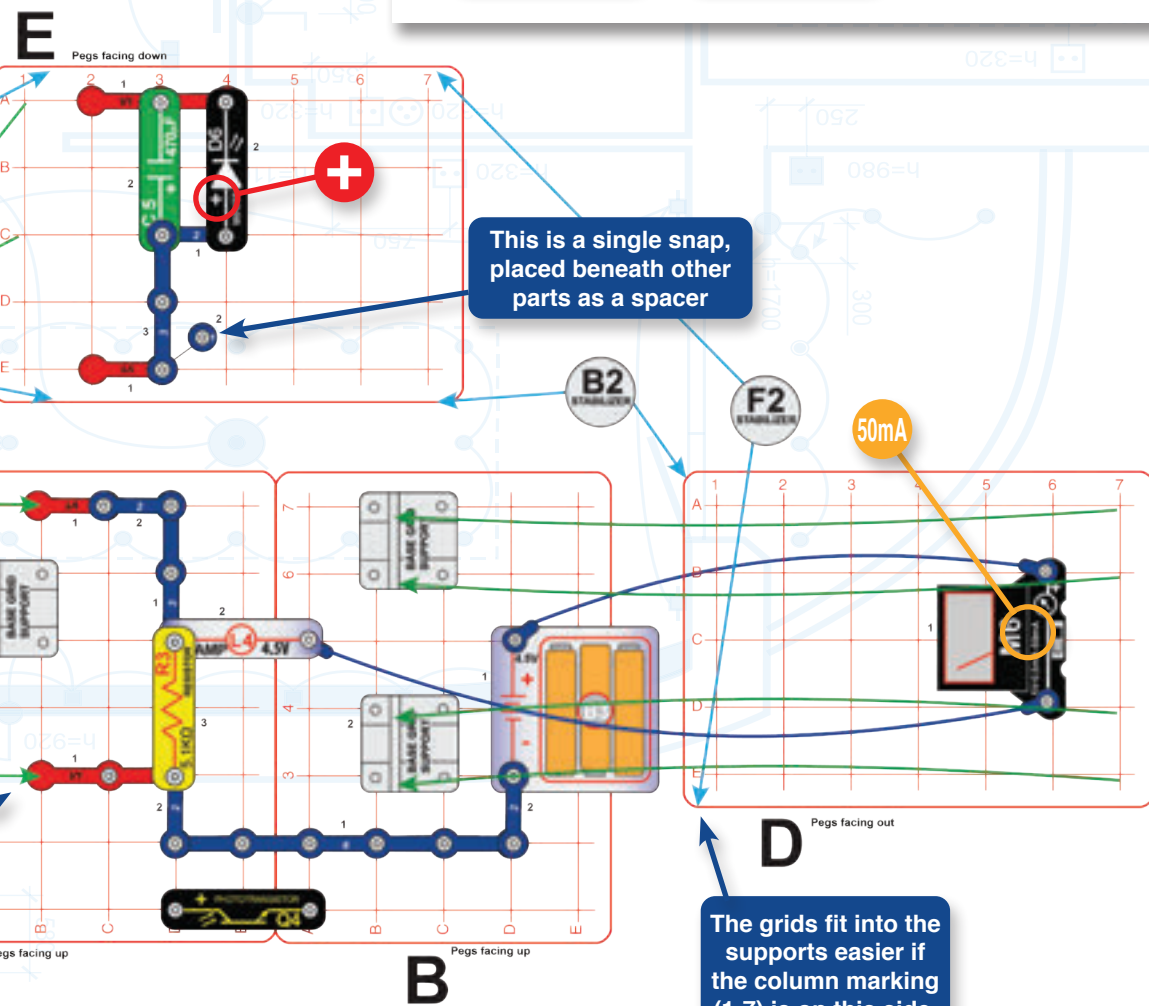
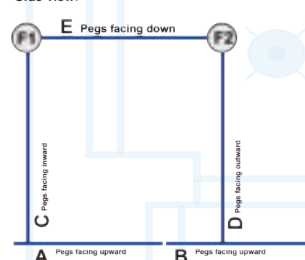

This is a single snap, placed beneath other parts as a spacer

The grids fit into the supports easier if the column marking (1-7) is on this side.

These red pieces are the same vertical snap wire (V1), mounted so it stands up.

The grids fit into the supports easier if the column marking (1-7) is on this side.

**Assembly (adult supervision recommended):**

1. Place base grid supports on base grids A & B.
2. Place parts (except the blue jumper wires) on base grids C & D, and install into base grid supports on grids A & B. The pegs should be facing inward on grid C and outward on grid D. Base grid colors are interchangeable, so you can use any color you like at any location.

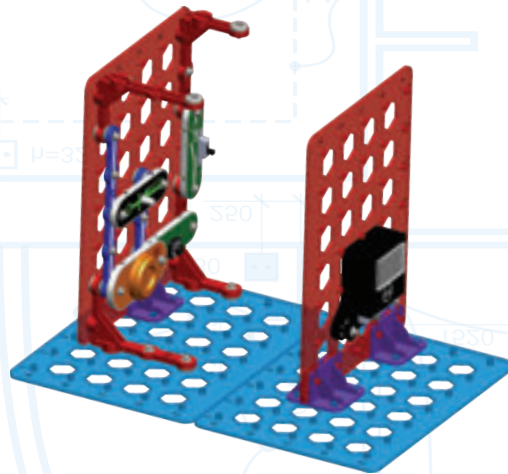

3. Mount grid E on top of grids C & D using 4 stabilizers, attaching the 2 vertical snap wires (V1) as you do it.

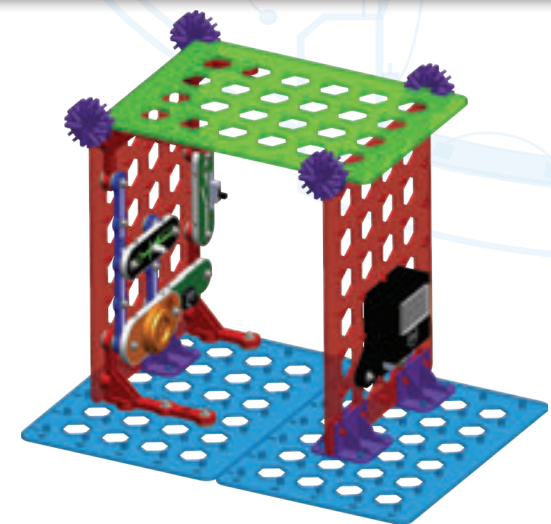

4. Place the remaining parts on grids A, B, & E, including the two blue jumper wires

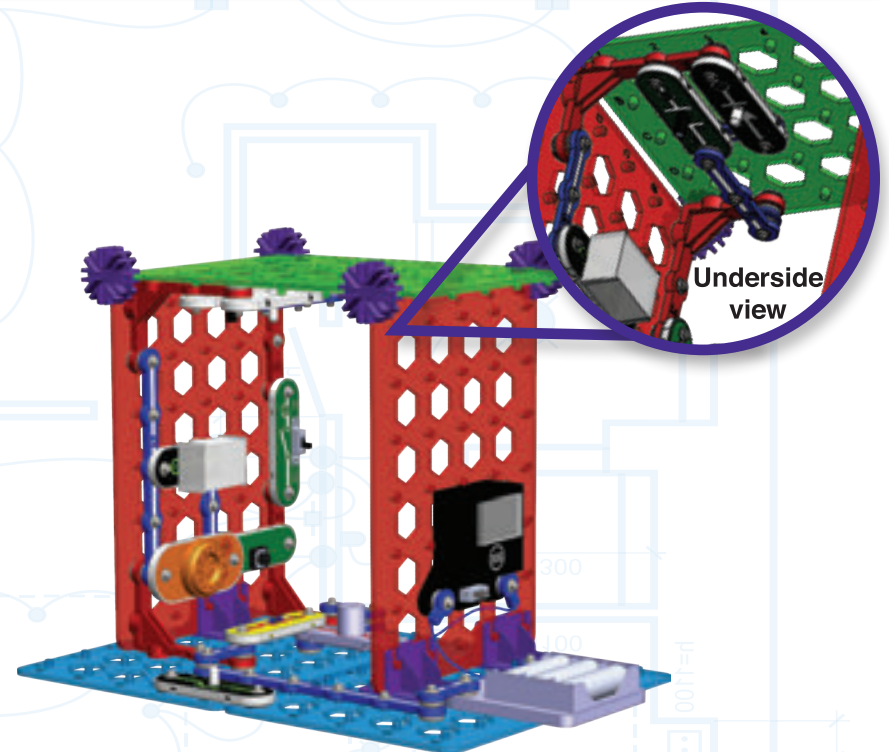

This circuit does not have an on-off switch, so connect one of the blue jumper wires last, and disconnect it when you are done using this circuit. Set the meter (M6) to the 50mA setting. Turn on the slide switch (S1) or push the press switch (S2) to make things happen, and watch the current on the meter. The lamp (L4) will not light.

The light covers and slides may be placed on the LEDs (D6 and D8) or lamp (L4) as decoration. Fold the slides as indicated and slide them into the slots on the cover, as shown.

You can replace either LED (D6 or D8) or the melody IC (U32) with the motor (M4) and fan. The motor represents a ceiling fan, fan for a furnace or air conditioner, or other appliance.

Go to [www.boffin.cz](http://www.boffin.cz) for an interactive 3D picture to help with constructing this circuit.

## This Circuit Demonstrates How Electricity Is Used In Your Home:

The **battery holder (B3)** represents the electricity supplied to your home. Usually the electricity is generated by a power station, but it could also come from a gasoline-powered backup generator, from solar panels on your roof, from wind turbines, or from larger batteries.

The **meter (M6)** is the meter that measures how much electricity you're using and reports it to your local electric company. This meter is usually located on the outside of your house or somewhere nearby. Your electric company uses this measurement to determine how much electricity you have to pay for. Electricity is measured in kilowatt hours (kWh), which is the amount of electricity needed to power a 1000W light bulb for 1 hour. The present cost of 1 kWh of electricity in the United States is around ten cents (\$0.10).

The **blue snap wires**, jumper wires, and vertical snap wires (V1) represent the wires in your walls, ceiling, and floor, by which electricity travels throughout your home to where it is needed.

The **press switch (S2)** turns on (or off) the color LED (D8, which represents your television or computer screen) and the melody IC (U32, which represents your stereo or sound device).

The **slide switch (S1)** controls the white LED (D6) the same way a switch on the wall controls a ceiling light.

The **470 $\mu$ F capacitor (C5)** keeps the white LED glowing for a moment after you turn off switch S1, giving you a little light to walk out of the room by. Try removing C5 and see how much faster the light turns off.

The **5.1k $\Omega$  resistor (R3)** represents various devices that are always on and using small amounts of electricity, like your refrigerator, hot water heater, computer, television, and Wifi. Change your M6 meter to the 0.5-mA setting and see how much current flows to R3 when the S1 and S2 switches are off.

The **lamp (L4)** represents a fuse and will only light if there is a problem in your circuit. Normally L4 will be off.

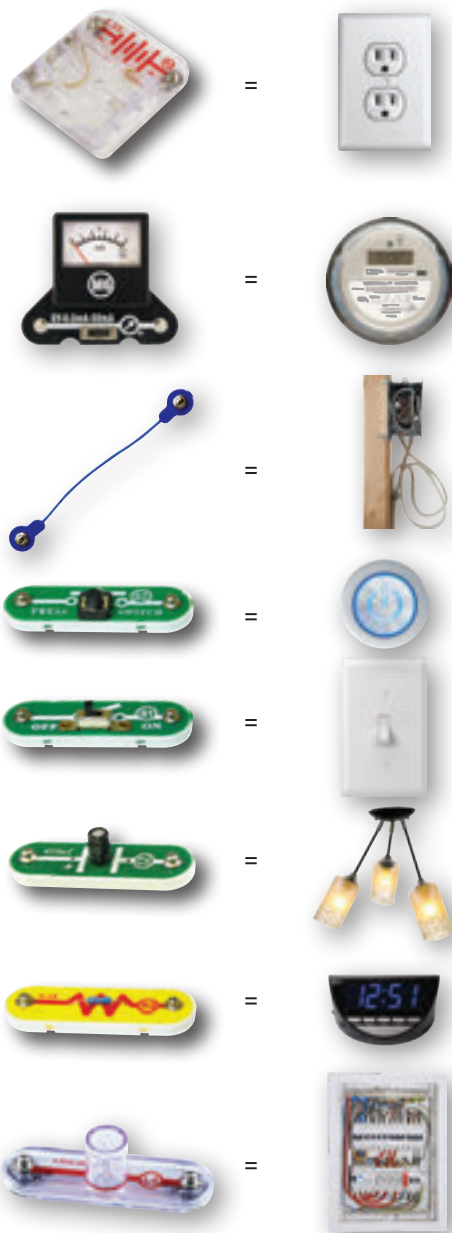

**What is a short circuit?** You can connect an extra jumper wire across the 5.1k $\Omega$  resistor to simulate the short circuit problems that often happen in homes. **A short circuit occurs when the resistance in an electrical pathway is suddenly and drastically reduced, so that the electricity suddenly flows very quickly.** If you connect an extra jumper wire across the 5.1k $\Omega$  resistor you bypass the resistor, so the current doesn't have to go through it at all (it goes through the jumper wire instead). Because there is nothing blocking its way, the current flows much more quickly through the jumper wire, causing meter M6 to go off the scale and the lamp to light up. Although the meter continues to show a current overload (off the scale), the resistance of the bright lamp slows down the current enough to prevent damage to the wires and batteries down the line (representing the electric company's infrastructure). Note that when the lamp is on, turning the S1 and S2 switches on does not illuminate the LEDs or make the melody sound. This is because the fuse has shut down the electricity flowing through your home as a result of the short circuit you caused across the 5.1k $\Omega$  resistor. When you remove the jumper wire from across the resistor, the lamp turns off, the meter returns to normal, and the S1 and S2 switches work again. (A similar fuse is also built into your B3 battery holder; but it resets automatically, so you don't even notice it's working.)

The phototransistor (Q4) is used here to help hold grids A & B together. It is not electrically connected to the other components.

Replacing either LED (D6 or D8) or the melody IC (U32) with the motor (M4) and fan creates a ceiling fan or the fan in a furnace, air conditioner, or other appliance.



# Project 9 | HOME SECURITY

Place a small object inside this house. If an intruder reaches in to grab it, the alarm will sound and the color LED will flash to scare the intruder away.

This circuit works like the security systems in a lot of people's homes, which are activated when a beam of light is broken or when motion or a loud sound (like a window breaking) is detected. Some home security systems are linked to a monitoring company, which contacts the police when the alarm is activated.

**How it works:** Light from the white LED (D6) shines on the phototransistor (Q4), which keeps the photoresistor's resistance low (so it blocks electrical flow very little). When the white LED is shining, the current that flows through resistor R3 must also flow through Q4. If a burglar blocks the light from the white LED, Q4's resistance increases, blocking the flow of current through Q4. The current flowing through R3 begins to flow into transistor Q2, which turns it on so that electricity now flows through the melody IC (U32) and color LED (D8) that are serving as your home alarm.

## Assembly (adult supervision recommended):

1. Place base grid supports on base grid A & B.
2. Place parts (except for the jumper wires) on base grids C & D, and install into base grid supports on grids A & B. The pegs should be facing inward.

Turn on the slide switch (S1); the white LED (D6) should be on, but there should not be any sound. Now place your hand between the white LED and the phototransistor (Q4); an alarm sounds and the color LED (D8) turns on.

Underside view

Other side view

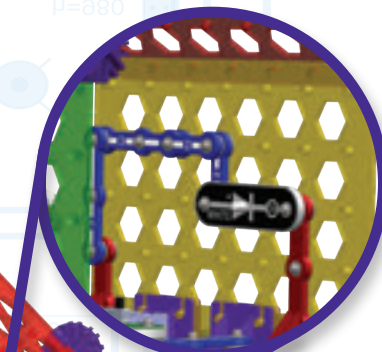
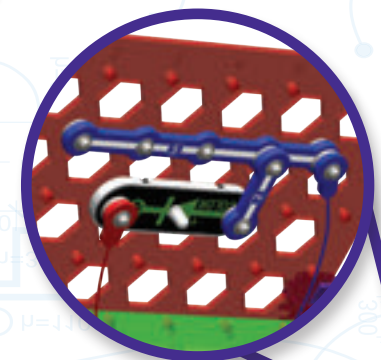
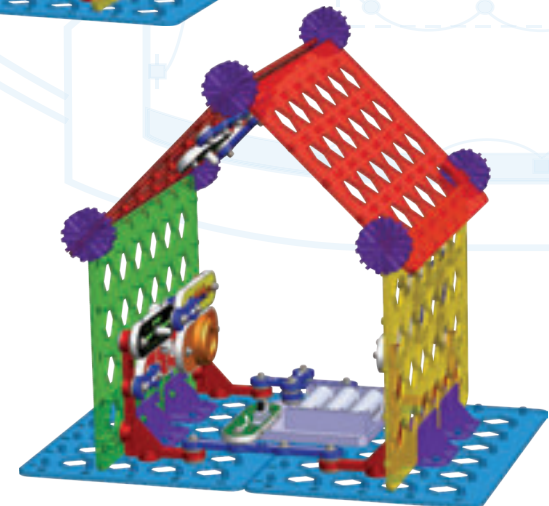
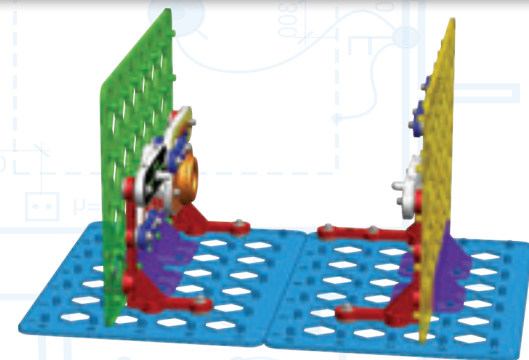
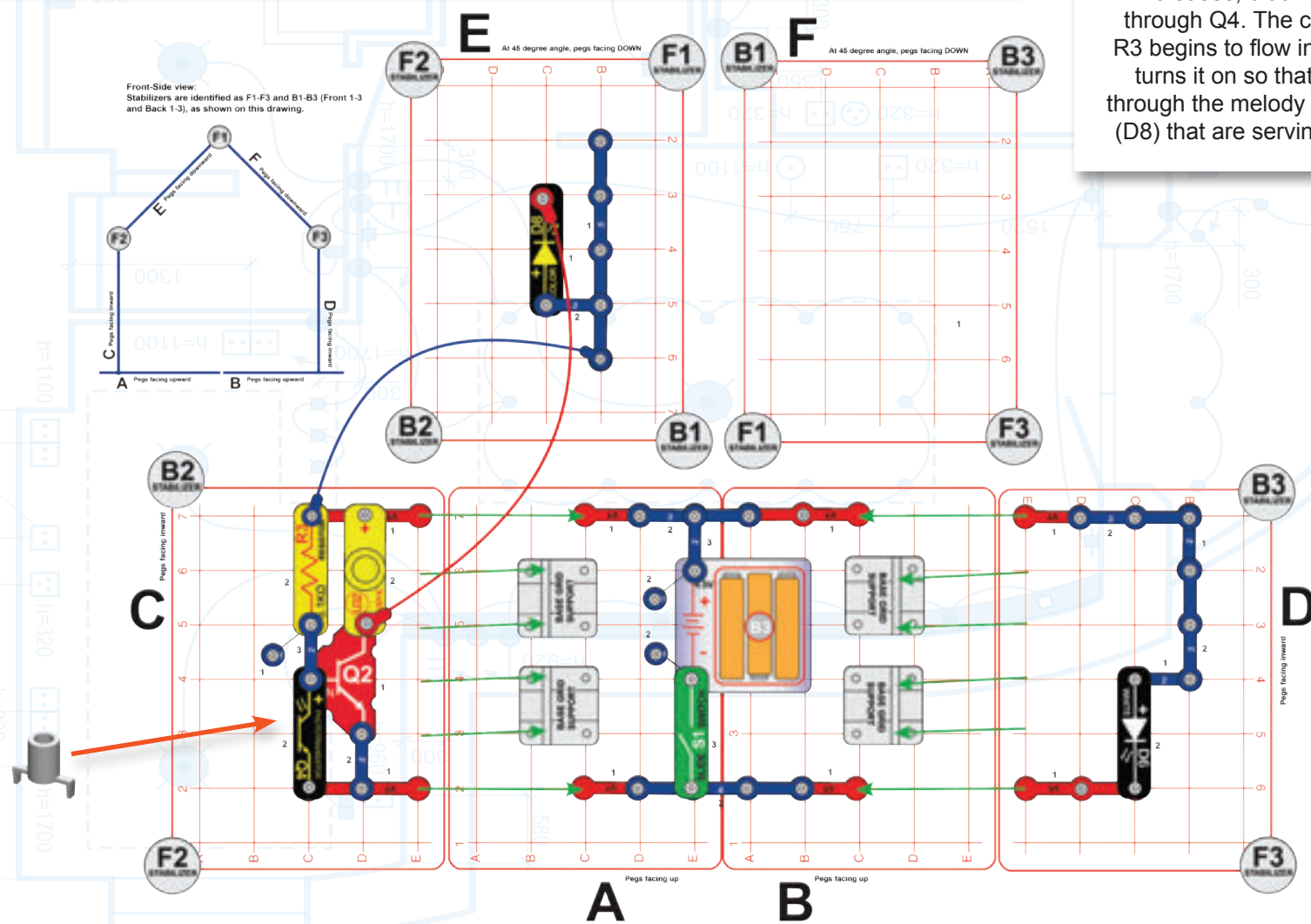

3. Place remaining parts on grids A & B.
4. Place parts (except jumper wires) on grid E.

**Easier Roofless Version:** Skip assembly steps 4 and 5, and the jumper wires from step 2. Grids E and F, and all parts on them are not used. The circuit works the same way except that the color LED (D8) is not included.

## Project 10 | BLOCK THE SOUND

### Assembly (adult supervision recommended):

1. Place base grid supports on base grids A&B.
2. Place parts on grids C&D and install into base grid supports on grids A&B.
3. Install remaining parts on grids A&B.

Turn on the slide switch (S1); the white LED (D6) and melody IC (U32) are on. Place your hand to block the light between the white LED and phototransistor (Q4); the sound stops. **Hint:** The light in your room may be keeping the sound on, to check for this, try pointing the phototransistor away from your room light.

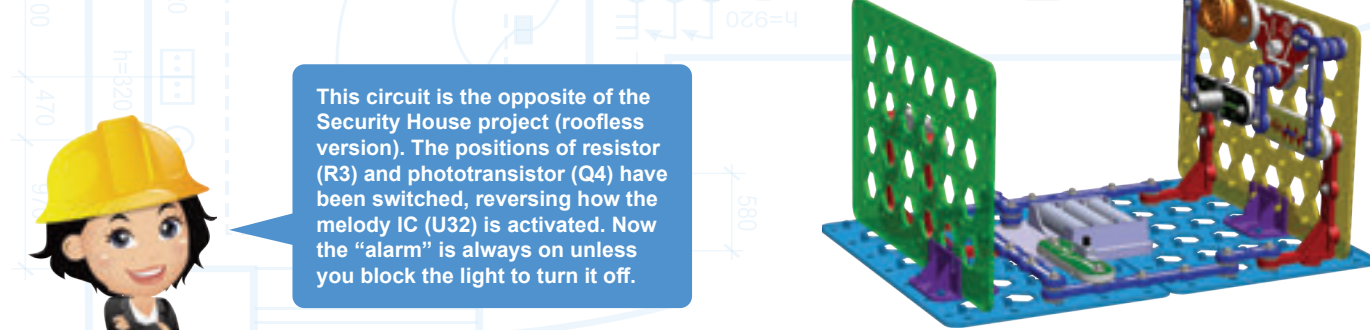
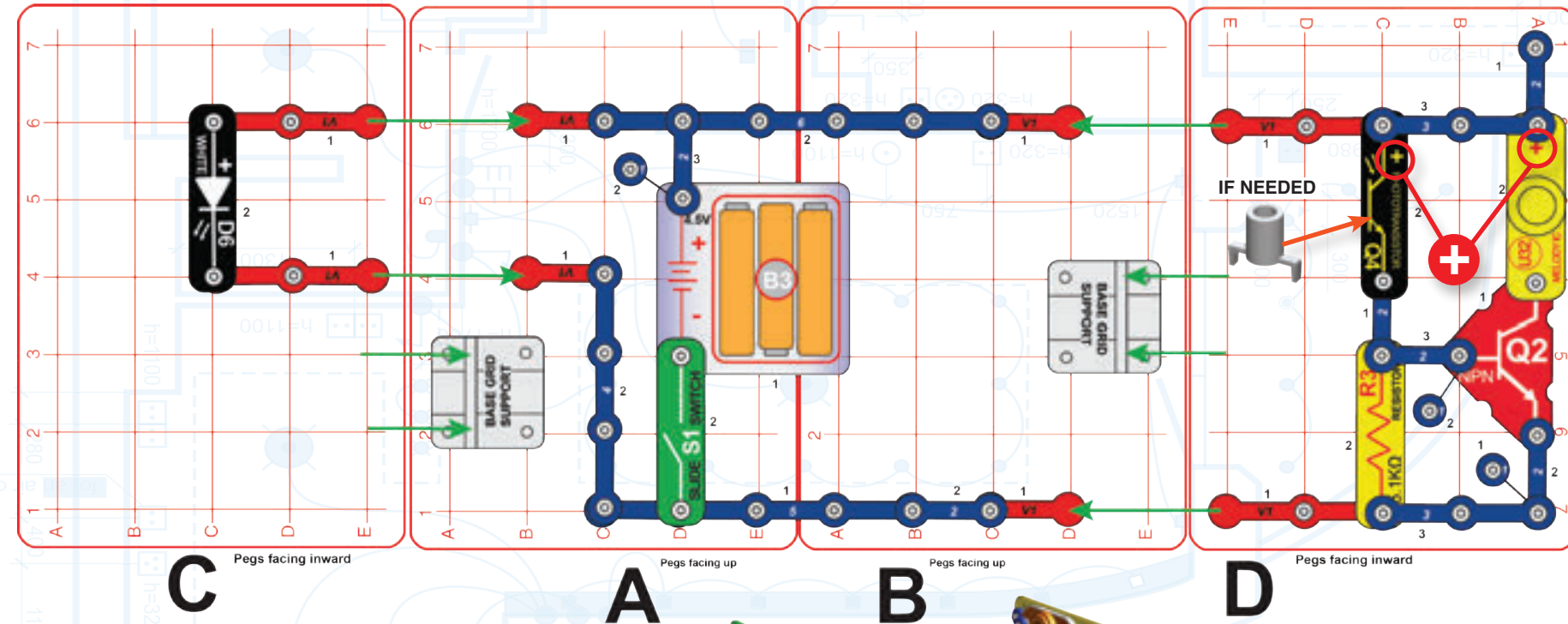

This circuit is the opposite of the Security House project (roofless version). The positions of resistor (R3) and phototransistor (Q4) have been switched, reversing how the melody IC (U32) is activated. Now the "alarm" is always on unless you block the light to turn it off.

## Project 11 | MATERIALS TESTER

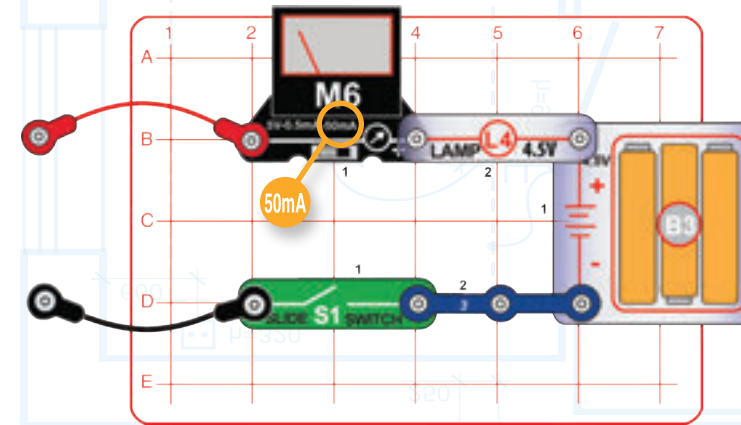

You can calculate the resistance of the materials you tested using Ohm's law: Resistance = Voltage / Current. From the information on your batteries, you know that the Voltage is around 4.5V, and you can measure the Current using the meter.

**WHAT IS RESISTANCE:** If you rub your palms together very quickly, they will begin to feel warm. The **friction** between your hands converts the physical motion of your body into heat. Resistance is the friction between an electric current and the material it flows through; and, like friction, resistance creates heat as well. We use electrical components called **resistors** to increase this electrical friction (resistance) to control how electricity flows through circuits. In this circuit, the resistor (R3) decreases the brightness of the LED, makes it dimmer but which also makes the batteries last longer.

Build the circuit and set the meter (M6) to the 50mA setting. Turn on the slide switch (S1) and touch (or connect) various materials between the loose ends of the red & black jumper wires. See which materials are good at transporting electricity by watching the meter current and lamp (L4) brightness. Try string, the electrodes, a shirt, plastic, paper, two of your fingers, wood, or anything in your home.

If the meter reads zero, switch it to the 0.5mA setting to see if there is just a very small current. To help protect the meter, always switch back to the 50mA scale before testing a new circuit.

Which materials gave the highest reading on the meter, and which gave the lowest?

Some materials, like copper, gold, and platinum metals, have very low resistance to electricity, meaning electrons travel through them very easily. This is why the lamp glows brightly and the meter measures a large current. Because we can conduct electricity (or make it flow) through these materials, we call them **conductors**.

Other materials, like paper, air, and plastic, have very high resistances to electricity, meaning they nearly block the flow of electrons completely. We call these kinds of materials **insulators**. If you incorporate these **insulating** materials into the circuitry, they cause the lamp to turn off and the meter to read a current of 0 even at its lowest setting (0.5 mA).

The best conductor known to humans is silver, but it would be very expensive to build circuits out of silver. Copper is the second-best conductor and, because it is much cheaper, it is used in almost all electrical wiring.

## Project 12 | DIM COLOR LIGHT

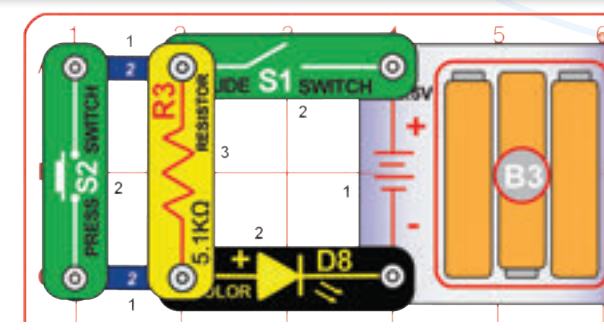

Build the circuit as shown and turn on the slide switch (S1); the color LED (D8) will be dim. Push the press switch (S2) to make the LED much brighter.

Next, replace the color LED (D8) with the white LED (D6) and compare the results.

## Project 13 | MINI BATTERY

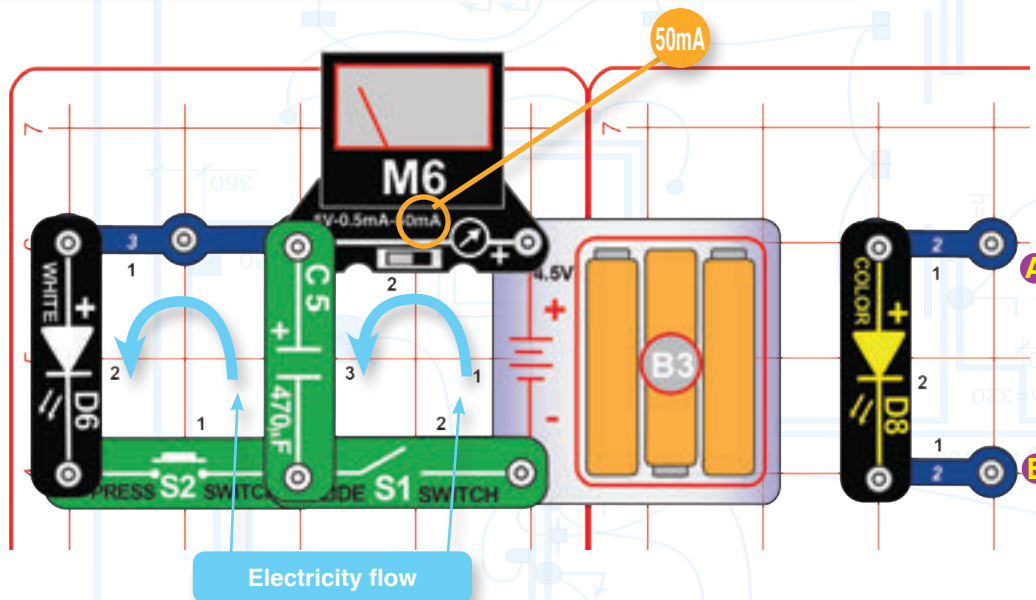

Build the circuit as shown and set the meter to the 50mA setting. Turn on the slide switch (S1) until the meter current drops to zero (indicating the 470µF capacitor (C5) is fully charged), then turn the switch off. Push the press switch (S2) to discharge the capacitor through the white LED (D6), lighting it. Turn S1 on and off and then push S2, several times.

Now turn S1 on and off, but then remove C5 from the circuit and place it across points A & B (“+” to A) and the color LED (D8) lights. Return C5 to the original circuit and repeat.

Pushing S2 while S1 is on connects the batteries directly to the white LED, and makes the effects of the capacitor difficult to see.

**Part B:** Replace the slide switch (S1) with the 5.1kΩ resistor (R3) and set the meter to the 0.5mA setting. Now the capacitor charges up very slowly, because the resistor limits its charging current.

Watch the current measured by the meter. Turning on S1 allows electricity to flow from the batteries into capacitor C5, causing the current to increase; but the flow of electricity stops when C5 is fully charged (that is, when all the electrons that can crowd into the capacitor do so). In this way, charging a capacitor is a lot like filling a water tank – you can only push as many electrons/water droplets into them as they can hold.

When S1 is off and you press S2, the electricity that is stored in C5 flows through S2 and lights the white LED. The LED stays lit until C5 is discharged, meaning all the electrons that crowded into the capacitor have dissipated or moved away. Dissipating a fully charged capacitor is like opening the valve at the bottom of a full water tank – once the path is cleared, both water and electrons will flow freely.

Capacitors like C5 store electricity like tiny rechargeable batteries. Although they can't store as much electricity as batteries, capacitors can store and release electricity much faster than batteries. And, like a battery, a capacitor can store electricity for a long time. To demonstrate this, once C5 is charged, remove it from the main circuit and place it across the mini circuit containing D8.

Capacitors and rechargeable batteries are used in many devices in your home to store information, like the date or time, when the devices are turned off or when the power goes out in your home.



## Project 14 | STORING ELECTRICITY

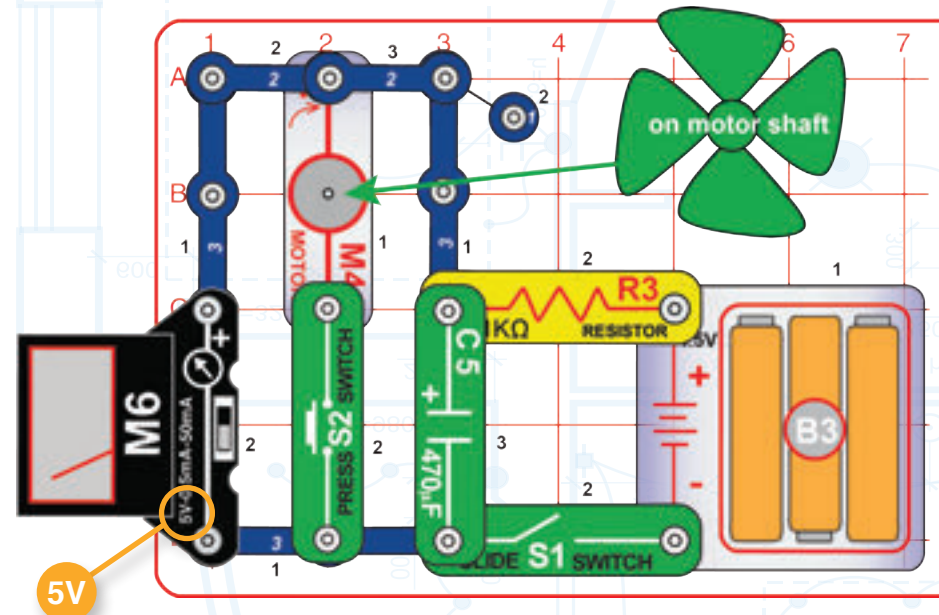

Build the circuit as shown and set the meter (M6) to the 5V setting. Turn on the slide switch (S1) and watch as the voltage slowly rises to 3V or more. Next push the press switch (S2) for a moment; the fan wiggles and the voltage drops to 0. Repeat this several times.

How it works: the 5.1kΩ resistor (R3) slows the flow of electricity from the batteries, causing the capacitor (C5) to charge up slowly and the voltage reading on the meter to increase. Pushing S2 discharges the capacitor, so that electricity flows through the motor. But the capacitor can only store enough energy to make the fan wiggle for a moment. Once the capacitor's charge has dissipated (meaning all the water has drained out of the tank), no more current will flow, so the fan does not move.





## Project 15 | FADER

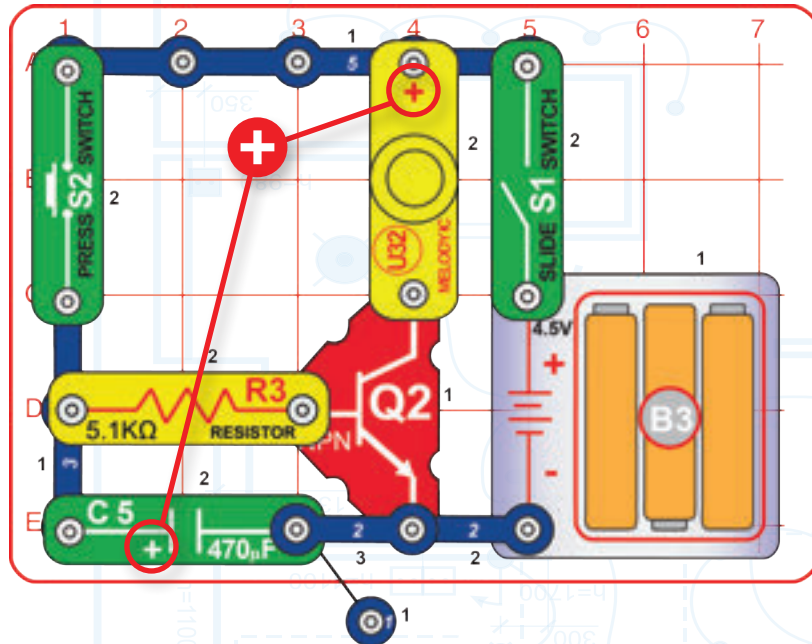

Build the circuit as shown, turn on the slide switch (S1), and then push the press switch (S2) to hear a melody. After you release the press switch the sound slowly fades out. Push the press switch to resume the sound.

**Part B:** Replace the melody IC (U32) with the motor (M4) and fan. The fan spins for a time after the press switch is released.

**Part C:** Replace the motor and fan with the white LED (D6). The LED slowly dims after you release the press switch.

Pressing S2 instantly charges up the 470µF capacitor (C5) and makes a control current flow into the NPN transistor (Q2), which turns on the melody IC. When S2 is released, the electricity stored in C5 slowly drains into Q2 through the 5.1kΩ resistor (R3), keeping the transistor and melody IC on for a short time until the capacitor has discharged. The white LED stays on longer than the melody IC or motor, because the white LED can operate at a lower current than the others.

Capacitors are used in fading circuits like this in your home, like when the light slowly fades as you leave the room or you hear a short stretch of music after you have turned off the radio.

## Project 16 | TIMED WALL OF FUN

### Assembly:

1. Place the base grid support on base grid B.
2. Place parts on grids C and install into base grid supports on grid B.
3. Install remaining parts on grids A&B.

Set the meter (M6) to the 0.5mA scale, push the press switch (S2), and then turn on the slide switch (S1). The motor (M4) spins the fan, the LEDs (D6 & D8) light, the melody IC (U32) plays a tune, and the meter measures the current charging the 470µF capacitor through the 5.1kΩ resistor. The meter shows the current decreasing and soon everything stops. Push the press switch to re-start the circuit.

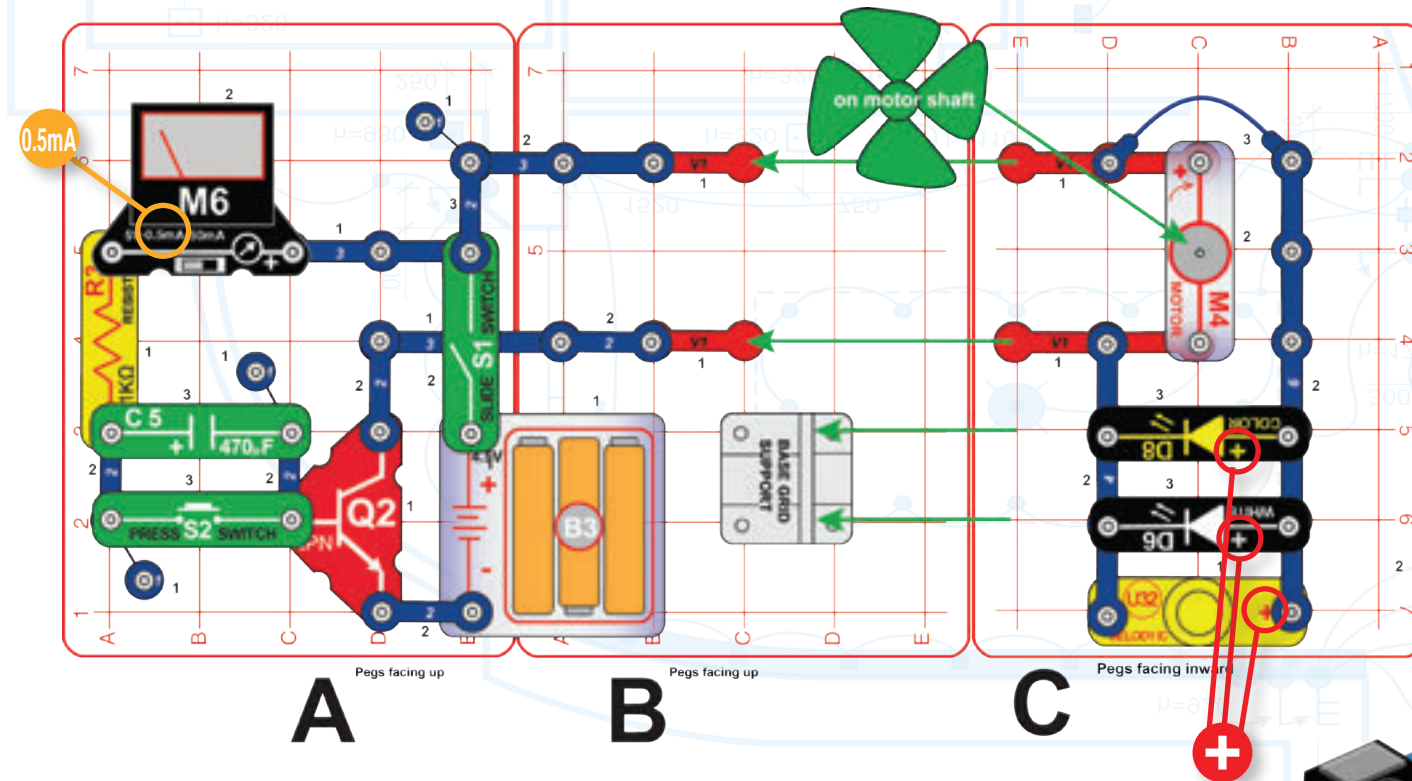

The lights, fan, and sound are on while capacitor C5 is charging, then stop as the capacitor gets fully charged. Pressing S2 instantly discharges the capacitor and resumes the fun. The circuit would run longer if you used a higher value resistor or capacitor, because then the charging would take longer.

# Project 17 | FESTIVE HOUSE

Do not leave the circuit for two minutes because the lamp will be hot.

**Assembly (adult supervision recommended):**

1. Place base grid supports on base grids A & B.
2. Place parts (except for the blue jumper wires) on base grids C & D, and install into base grid supports on grids A & B. The pegs should be facing inward.

4. Mount grids E & F, at the angles shown and with pegs facing down, on top of grids C & D using 6 stabilizers, and attaching 2 vertical snap wires (V1) as you do it. Adjust the positions of the stabilizers as needed.
5. Add the remaining parts on grids E & F.

3. Place remaining parts on grid A & B.

6. Add the 2 blue jumper wires, and place the fiber optic festive tree in its holder and on the color LED (D8). Turn on the slide switch (S1) to light the LEDs (D6 & D8) and lamp (L4).

Front-Side view:  
Stabilizers are identified as F1-F3 and B1-B3 (Front 1-3 and Back 1-3), as shown on this drawing.

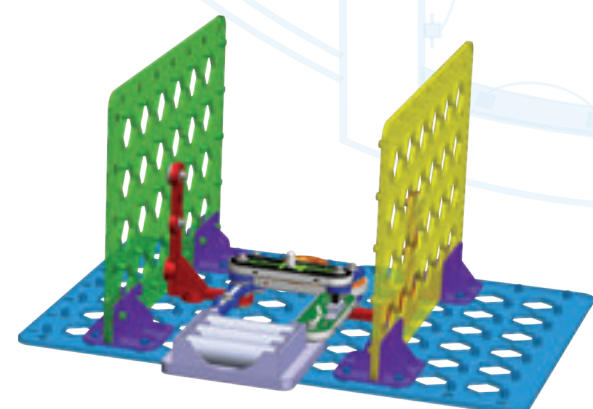
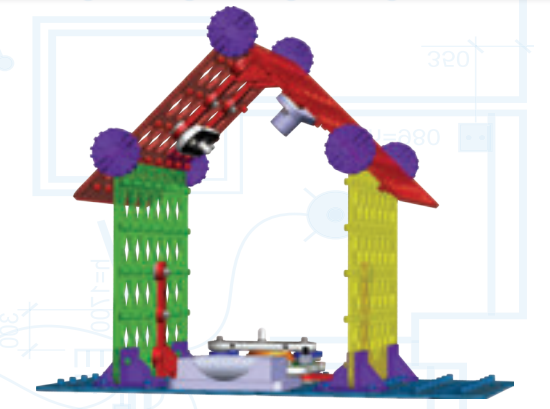
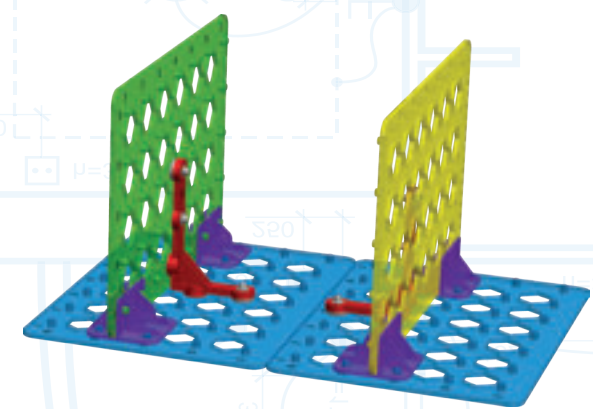
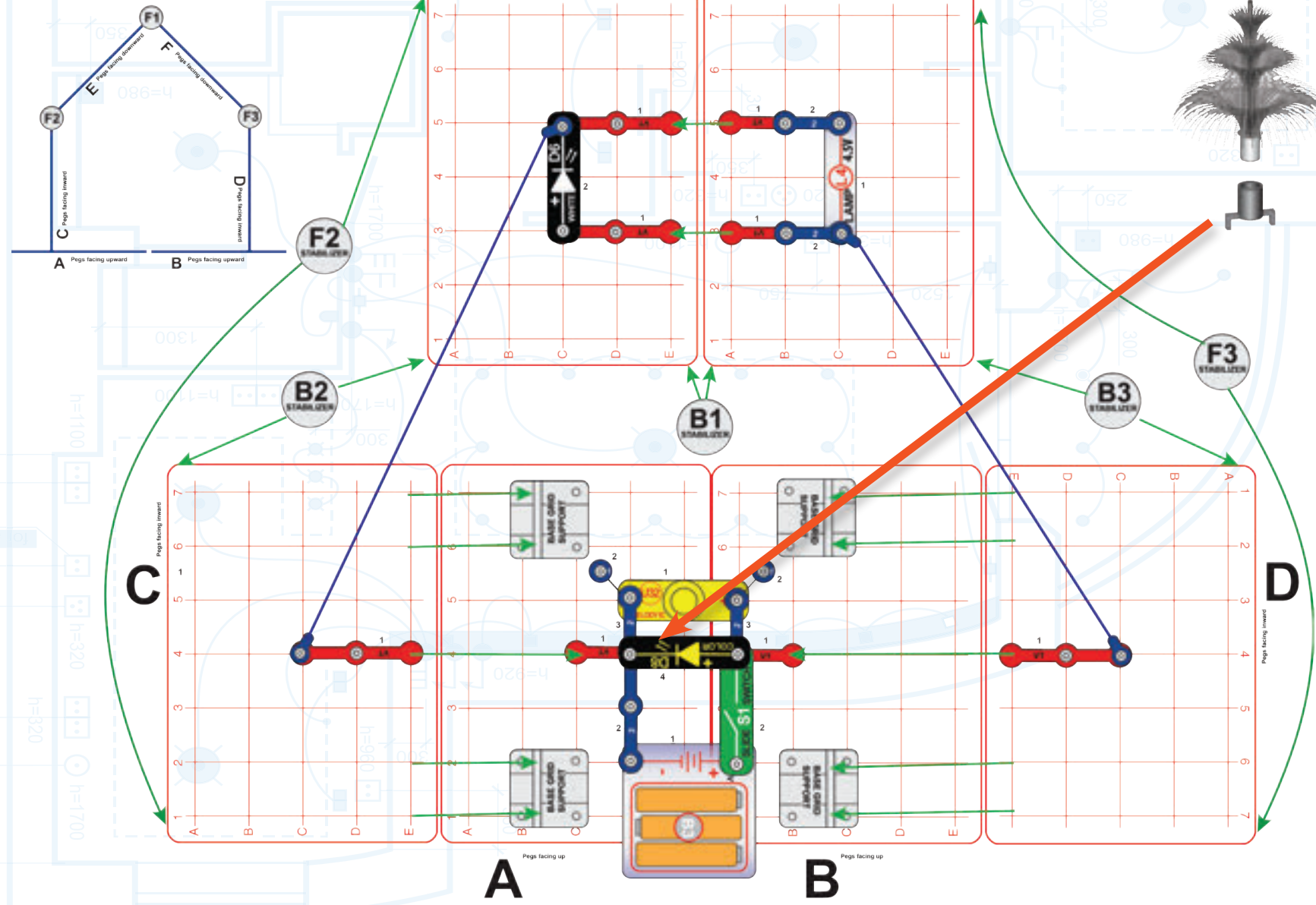

## Project 18 | ELECTRIC HEATER

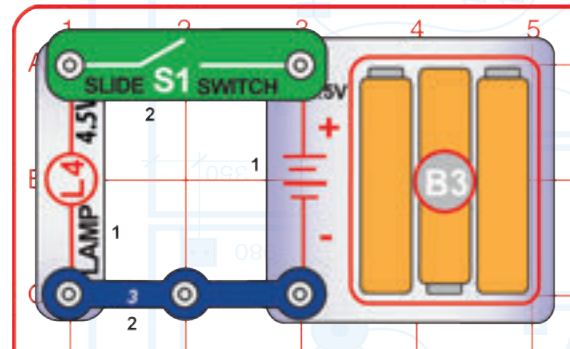

Turn on the slide switch (S1), cover the holes in the top of the lamp (L4) with your finger, and wait. After a minute or so you should feel the lamp heating up. *Do not leave the circuit for two minutes because the lamp will be hot.*

**CAUTION:** very warm lamp enclosure.

Incandescent light bulbs like L4 contain a special thin wire that gets so hot when electricity flows through it that it glows. Only about 5% of the electricity used in incandescent light bulbs is used to make light; the rest becomes heat, which is why you can feel the L4 lamp heat up when you cover its venting holes. Electric space heaters convert electricity to heat in a similar way to warm up a room.



## Project 19 | WATER COMPLETES CIRCUIT

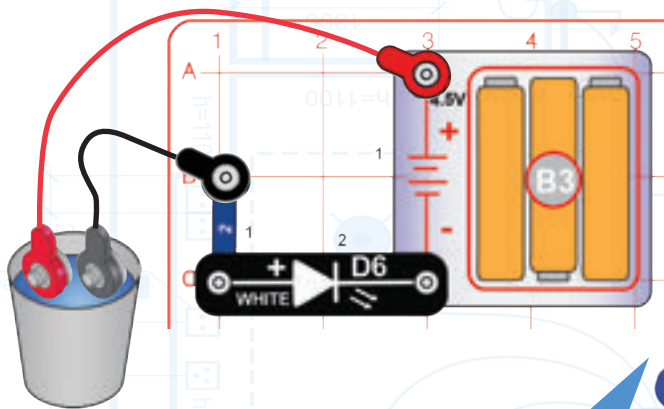

**Distilled** (or filtered) water has almost no impurities (or things other than water molecules) in it. Because of this, distilled water has a very high electrical resistance, meaning that current doesn't flow through it easily.

The water that comes out of your tap has chlorine, fluoride and other chemicals to make it safe for you to drink. Because of these impurities, tap water has a low electrical resistance, meaning that current flows through it rather easily.

Adding salt (sodium chloride) to the water decreases its resistance even more, because this adds sodium and chloride ions (or moveable charges) to the mix. This is why it is incredibly important that you don't enter a swimming pool when there's a chance of lightning. If lightning occurs anywhere near the pool, the high-energy electrons will follow the path of least resistance straight into the water and, because your body is mostly water, into you.

Build the circuit as shown, leaving the ends of the red & black jumper wires unconnected for now. Turn on the slide switch (S1); the white LED (D6) should be off.

Place the loose ends of the red & black jumper wires into a cup of water (but not distilled water), without them touching each other. The white LED should be on now, because water conducts electricity, completing this circuit.

Try dissolving some salt in the water or using different liquids, and see how the LED brightness changes. You can also replace the white LED with the color LED (D8).

**Don't drink any liquids used here.**

There is no danger in touching the circuits you build with Boffin because of the low-voltage batteries they use (4.5V). But the electricity from your electric company is a much higher voltage (120V), and it can seriously injure and even kill you if it enters your body. This is why it is important that you never touch a wire without disconnecting it from the electricity (by turning it off and unplugging it) or without placing proper insulation (materials that electrons cannot travel through) between you and the wire (which is why most of the wiring inside appliances has a colorful plastic coating).

Because tap water is **conductive** (low resistance), dropping a **live** wire (a wire that is plugged into your house's electricity) into your bath connects every wet part of your body to the 120V electricity flowing through the wiring in your house.

**Part B:** Instead of placing the red & black jumper wires in water, touch the metal part of each with your fingers, using your body to complete the circuit. Wet your fingers to get better electrical contact. The white LED (D6) should be on, but brightness may vary.

## Project 20 | AUTOMATIC LIGHT

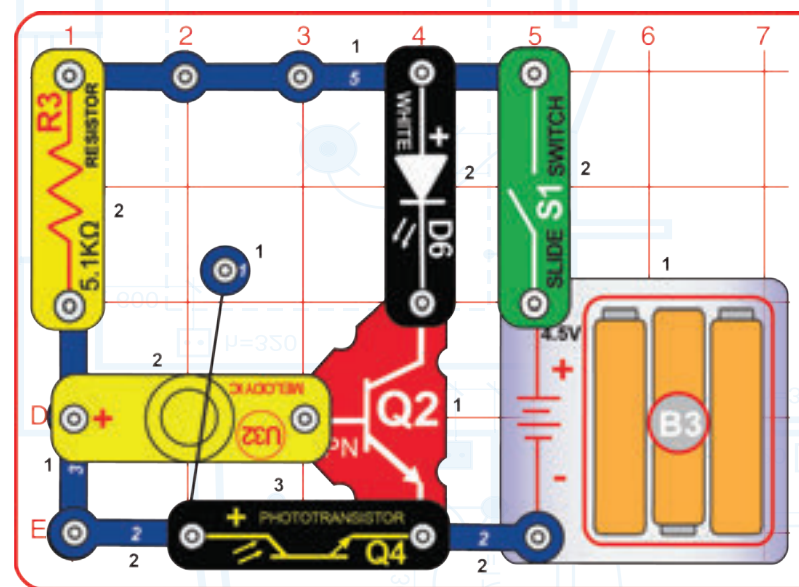

Build the circuit and turn on the slide switch (S1). The white LED (D6) will be on unless there is bright light on the phototransistor (Q4), so vary the amount of light shining on the phototransistor.

The melody IC (U32) will make little or no sound (it is used here to help control the phototransistor current).

This circuit automatically turns on the light when the room starts getting dark.



## Project 21 | TREE LIGHTING

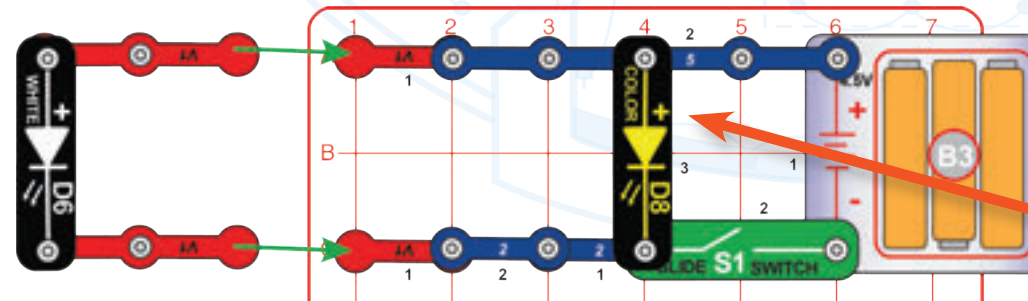

Use two vertical snap wires (V1) and mount the white LED (D6) on them so it will shine towards the festive fiber tree, mounted on the color LED (D8). Turn on the slide switch (S1) and place the circuit in a dimly lit room.

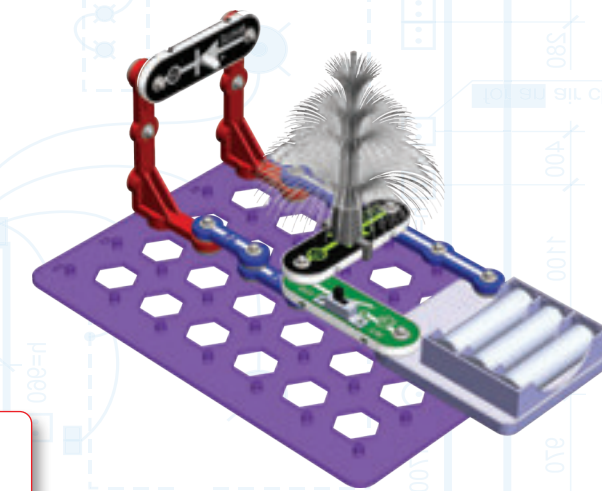
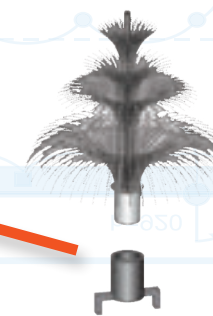

## Project 22 | TRANSISTOR AMPLIFIER

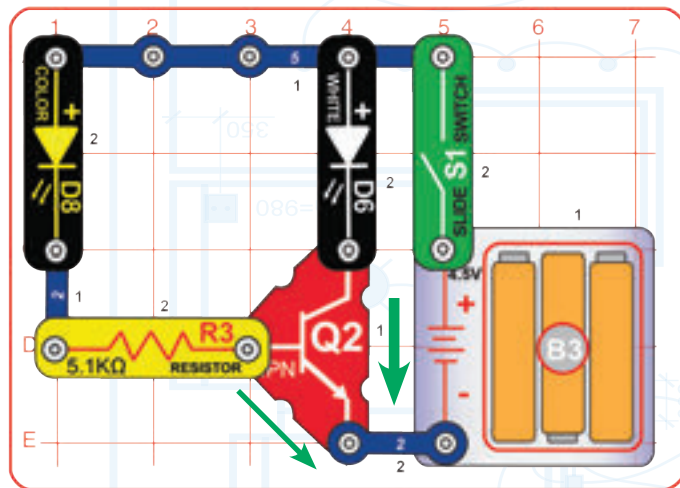

Turn on the slide switch (S1). The color LED (D8) is dim but the white LED (D6) is bright.

**Part B:** Remove either LED (D6 or D8) and see what happens to the other one.

**Part C:** Swap the locations of the white LED (D6) and the color LED (D8).

**Part D:** In the original circuit, replace the color LED with the press switch (S2). Notice that the white LED is only on when S2 is pressed.

The NPN transistor (Q2) is a current amplifier, meaning it takes a small current and makes it larger. When a small current flows into Q2 through the left branch (through D8), a larger current will flow into Q2 through the right branch (with D6). Green arrows show the current flow. This is why the LED on the right side will be brighter than the LED on the left side. In fact, the current in the right branch can be as much as 100 times larger than the current in the left branch.

The left branch controls the right branch, so removing D8 turns off D6, but removing D6 does not affect D8.

A small electric current may be flowing through the color LED even when it appears to be off. This small current, when it passes through the NPN transistor (Q2) and gets amplified, can be enough to keep the white LED on.



## Project 23 | LIGHT & SOUND

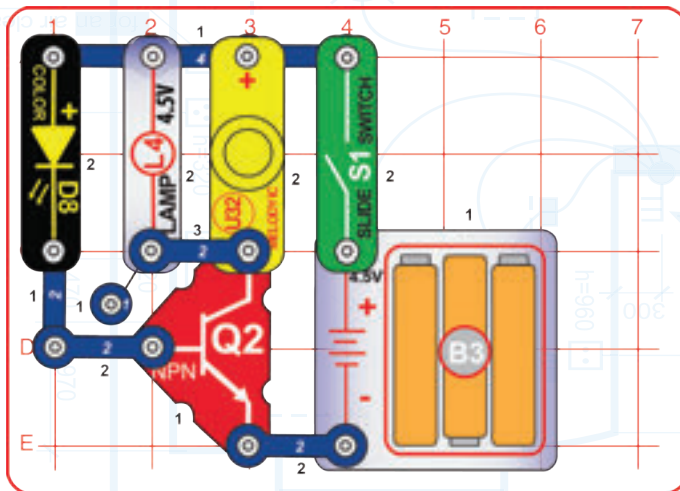

Turn on the slide switch (S1) to get a blinking light with funky sounds. You can change the sound by removing the lamp (L4).

This circuit uses the blinking pattern of the color LED (D8) to control the current flowing through the lamp (L4) and melody IC (U32), making them go on and off. The NPN transistor (Q2) allows D8 to control the other electrical components. The melody IC does not start up instantly, so the blinking pattern of the color LED produces unusual sound effects in the melody IC.



## Project 24 | AUDIO FAN SPEED ADJUSTER

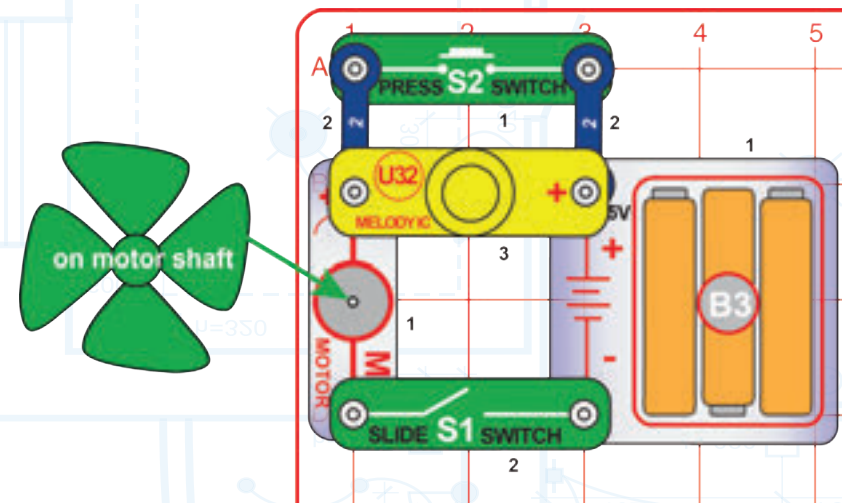

Turn on the slide switch (S1). The fan should spin and there should be sound from the melody IC (U32). If the fan does not spin then push the press switch (S2) to get the fan started.

The speed of the fan varies depending on the current flowing into the melody IC, and the melody IC current depends on the sound it is making.



## Project 25 | DISTANCE LOSS SIMULATOR

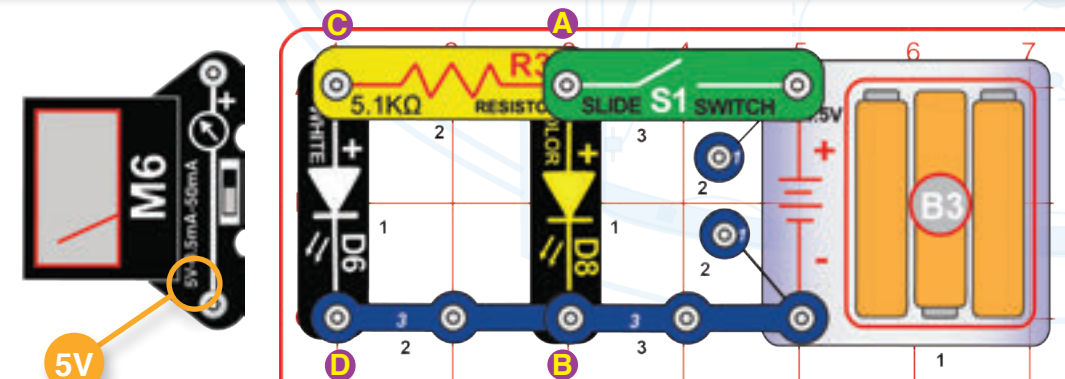

This circuit is intended to simulate electrical transmission loss over long distances. Turn on the slide switch (S1). The color LED (D8) is bright but the white LED (D6) is not at full brightness. Set the meter (M6) to the 5V setting and place it across points A & B to measure the voltage across the color LED, and then across points C & D to measure the voltage across the white LED.

The color LED is only separated from the batteries by the slide switch (S1), so it gets the full battery voltage (pressure) when the switch is on. The white LED is separated from the batteries by the 5.1kΩ resistor (R3) (which represents the loss of electrical energy when it is transmitted over long distances); this slows down the current so that the white LED has a noticeably lower voltage across it.



## Project 26 | LIGHT-CONTROLLED LIGHT

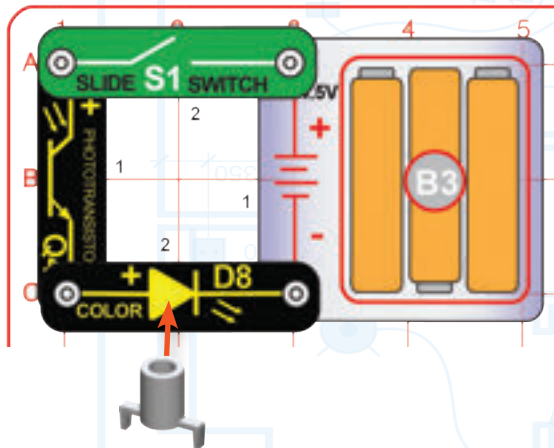

Turn on the slide switch (S1) and vary the amount of light shining on the phototransistor (Q4). The brighter the light on the phototransistor, the brighter the color LED (D8) should be. The Q4 attachment is placed on D8, to make it easier to see if it is dim.

Next, replace the color LED (D8) with the white LED (D6). Compared to the color LED, the white LED requires more light on Q4 to turn on, but gets brighter when there is a lot of light on Q4.



The phototransistor uses light to control electric current. When more light shines on the phototransistor, the current flowing through it increases, making the LED glow more brightly.

## Project 27 | PHOTO CONTROL

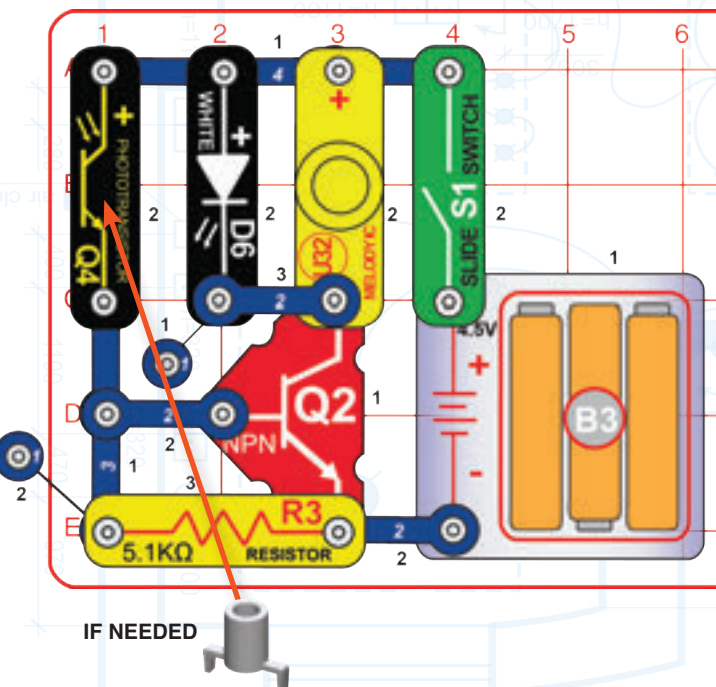

Build the circuit and turn on the switch (S1). The white LED (D6) and melody IC (U32) will be on if there is light on the phototransistor (Q4); cover the phototransistor to turn them off. If the LED and horn turn on too easily then place the Q4 attachment on Q4 to restrict the light to it. You can also replace D6 or U32 with the color LED (D8) or the lamp (L4).

**Part B:** Remove the resistor (R3), and see how its sensitivity to light changes. (The resistor (R3) diverts some current from the phototransistor to keep the circuit from being too sensitive to light.)

**Part C, Adjustable Speed Fan:** In the original circuit, replace the melody IC (U32) with the motor (M4) and fan. Vary the amount of light shining on the phototransistor to adjust the fan speed.

**Part D:** In the original circuit, swap the locations of Q4 and R3 (for Q4, put "+" on left). Now the light control is opposite.

## Project 28 | INFRARED-CONTROLLED LIGHT

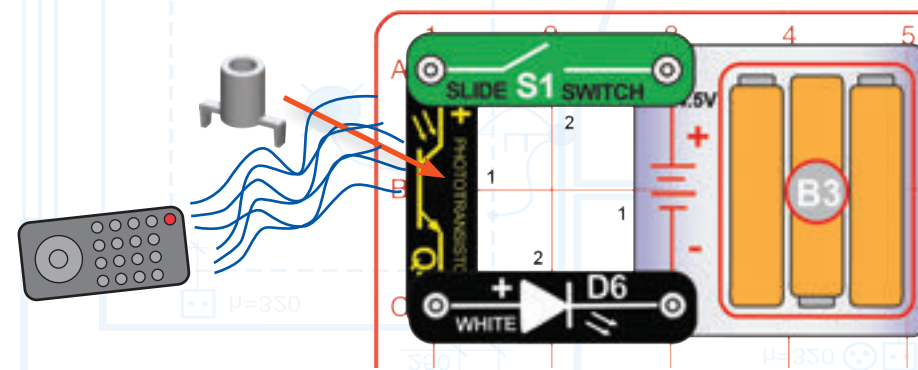

You need an infrared remote control for this project, such as any TV/ stereo/DVD remote control in your home.

Build the circuit and turn on the switch (S1). Place the Q4 attachment on the phototransistor (Q4). Position the circuit away from lights in the room so that the white LED (D6) is off. Point your remote control directly into the Q4 attachment, and press any button to turn on the white LED. The LED may not get very bright.

The phototransistor detects light, including infrared light that is invisible to the human eye.



## Project 29 | IR CONTROL

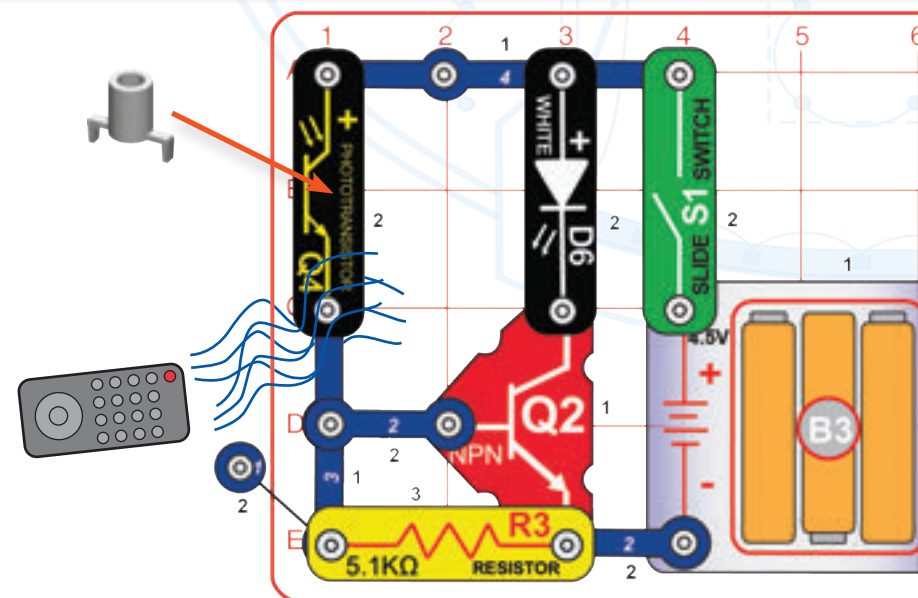

You need an infrared remote control for this project, such as any TV/ stereo/DVD remote control in your home.

Turn on the slide switch (S1) and place the Q4 attachment on the phototransistor (Q4). Position the circuit away from lights in the room so that the white LED (D6) is off. Point your remote control directly into the Q4 attachment, and press any button to turn on the white LED.

Note that when the phototransistor (Q4) is activated by room lights the white LED is on continuously, and when the phototransistor is activated by your infrared remote control LED will be blinking.

The phototransistor detects light, including infrared light that is invisible to the human eye. The white LED blinks even if you press the remote control continuously, because the signal that is coming from your remote control is a stream of infrared light bursts. Each burst of infrared light causes a burst of current to flow through the LED, making it blink.



# Project 30 | 2-STORY HOUSE

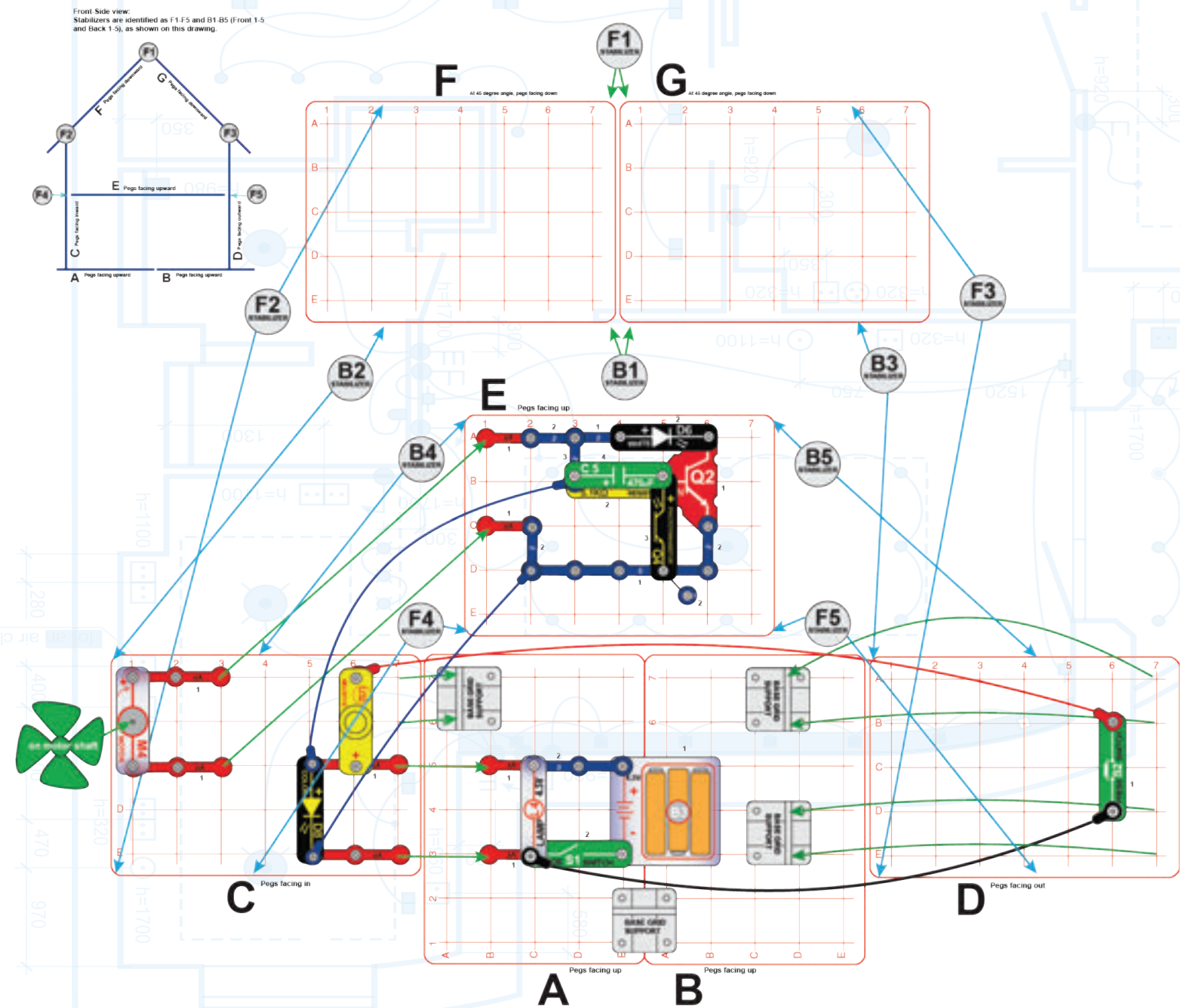

The light covers and slides may be placed on the LEDs (D6 and D8) or lamp (L4) as decoration. Fold the slides as indicated and slide them into the slots on the cover, as shown.



## Assembly (adult supervision recommended):

1. Place base grid supports on base grid A & B.
2. Place parts (except for the jumper wires) on base grids C & D, and install into base grid supports on grids A & B. The pegs should be facing inward for grid C and outward for grid D.
3. Place remaining parts on grids A & B.
4. Place parts on grid E, and mount grid E onto grids C & D using 4 stabilizers, connecting to the vertical snap wires (V1) on grid C as you do this. Adjust the positions of the stabilizers as needed. Attach all jumper wires if you have not done so already.
5. Mount grids F & G, at 45 degree angles and with pegs oriented down, on top of grids C & D using 6 stabilizers. Adjust the positions of the stabilizers as needed.

Turn on the slide switch (S1). The lamp (L4), motor (M4), and color LED (D8) should be on. Push the press switch (S2) to hear a doorbell (from the melody IC (32)). The white LED (D6) is bright if room is dark, and gets dim as you shine light on phototransistor (Q4); shine a bright light on Q4 to turn off D6. If desired, place the light covers with a slide on any of the LEDs or the lamp. *Do not leave the circuit for two minutes because the lamp will be hot.*



# Project 31 | 3-WALL HOUSE

Front-Side view:  
Stabilizers are identified as F1-F3 and B1-B3 (Front 1-3 and Back 1-3), as shown on this drawing.

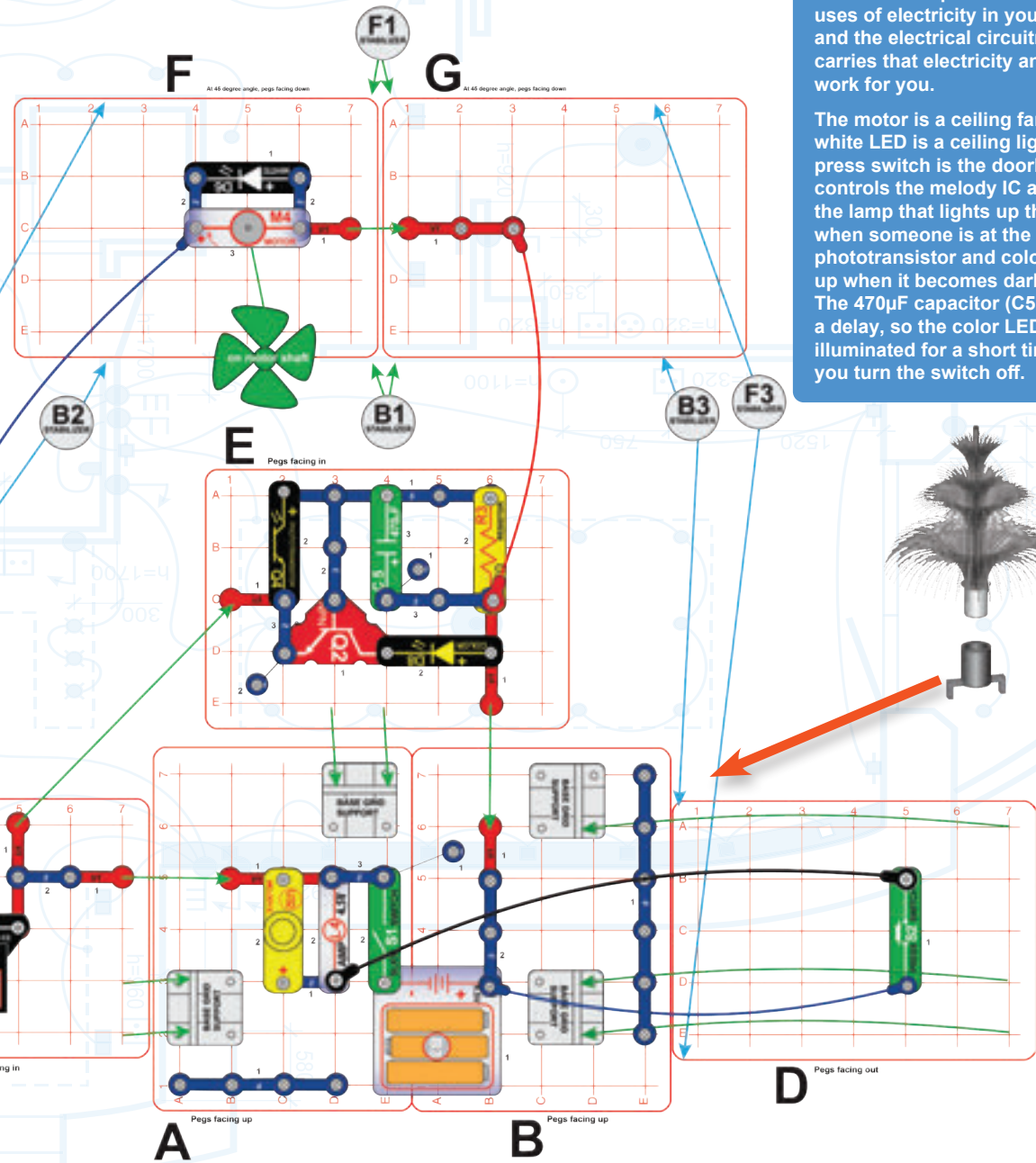
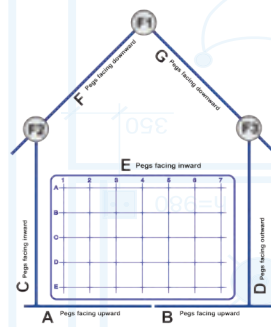

The circuit built in this project is pictured on the front of your box and manual, so you can use that picture as a guide here.

This circuit represents the different uses of electricity in your home and the electrical circuitry that carries that electricity and makes it work for you.

The motor is a ceiling fan. The white LED is a ceiling light. The press switch is the doorbell, which controls the melody IC as well as the lamp that lights up the room when someone is at the door. The phototransistor and color LED light up when it becomes dark outside. The 470µF capacitor (C5) adds a delay, so the color LED stays illuminated for a short time after you turn the switch off.

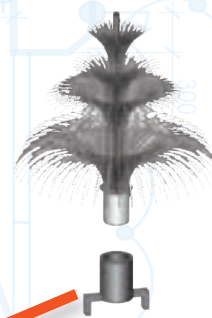

The light covers and slides may be placed on the LEDs (D6 and D8) or lamp (L4) as decoration. Fold the slides as indicated and slide them into the slots on the cover, as shown.

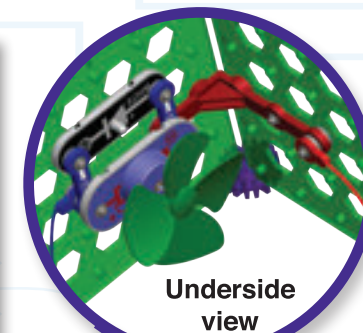

Underside view

**Note:** the 4-snap, 6-snap wires, the fiber optic festive tree and its mounting base (which may be laid on the 6-snap wire so it balances the festive tree) are only included as decoration and are not necessary.

## Assembly (adult supervision recommended):

1. Place base grid supports on base grid A & B.
2. Place parts on base grids C & D (leaving one end of the jumper wires unconnected for now), and install into base grid supports on grids A & B. The pegs should be facing inward on grid C and outward on grid D.
3. Place parts on grid E, and install into the base grid support on grid A, connecting to the vertical snap wire (V1) on grid C as you do this.
4. Place remaining parts on grids A & B.
5. Connect a vertical snap wire (V1) between grids F & G, and mount those grids at 45 degree angles and with pegs oriented down on top of grids C & D using 6 stabilizers. Adjust the positions of the stabilizers as needed.
6. Place the remaining parts on grid F, and connect to the blue jumper wire on grid C.
7. Add the remaining jumper wires (1 blue, 1 black, and 1 red).

Set the meter to the 50mA scale and turn on the slide switch (S1). The motor (M4) spins the fan and white LED (D6) lights; the meter measures the current through them. The color LED (D8) is bright if room is dark, and gets dim as you shine light on phototransistor (Q4); shine a bright light on Q4 to turn off D8. Push the press switch (S2) to hear a doorbell sound from the melody IC (32) and light the lamp (L4). If desired, place the light covers with a slide on any of the LEDs or the lamp.

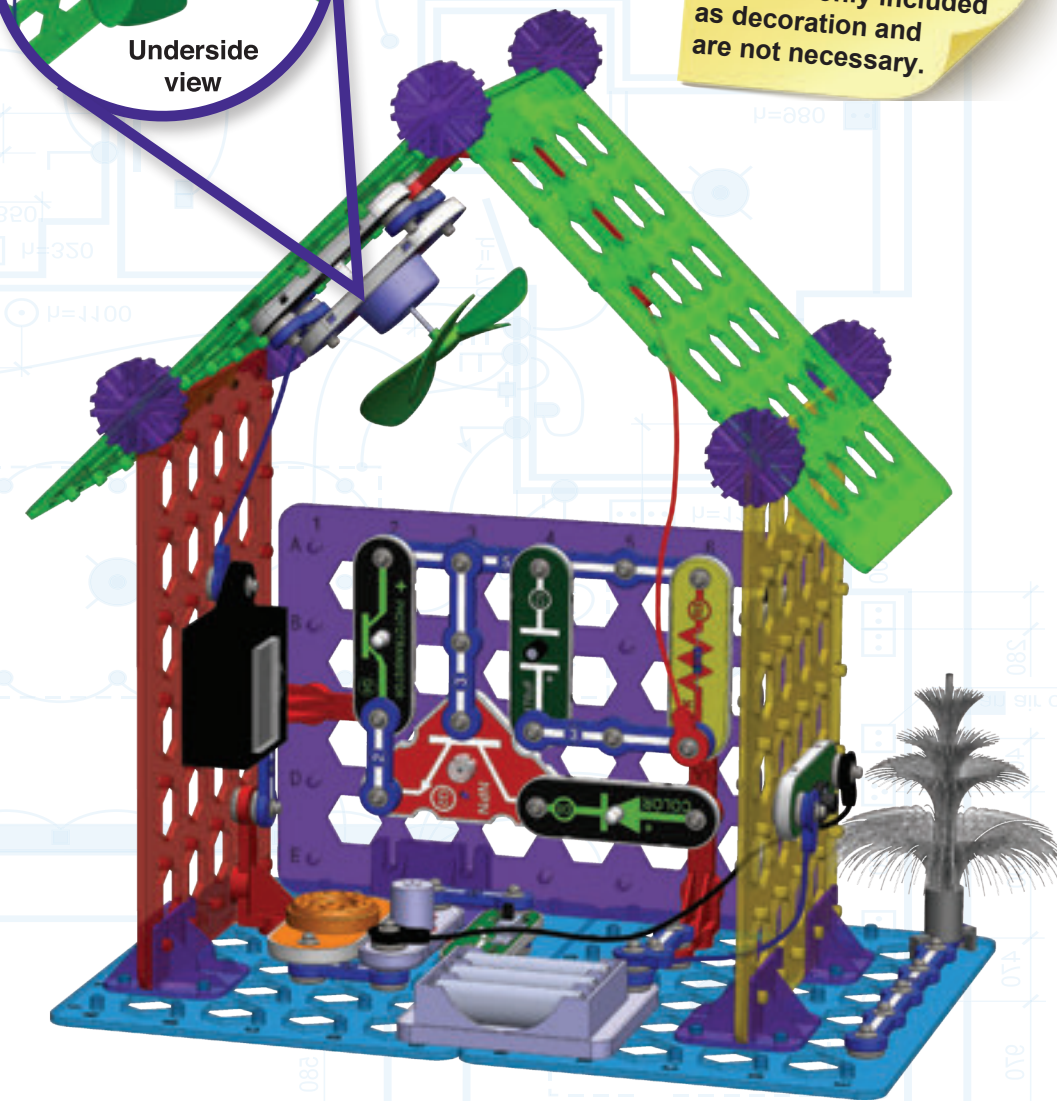

# Project 32 | HIGH CEILING HOUSE

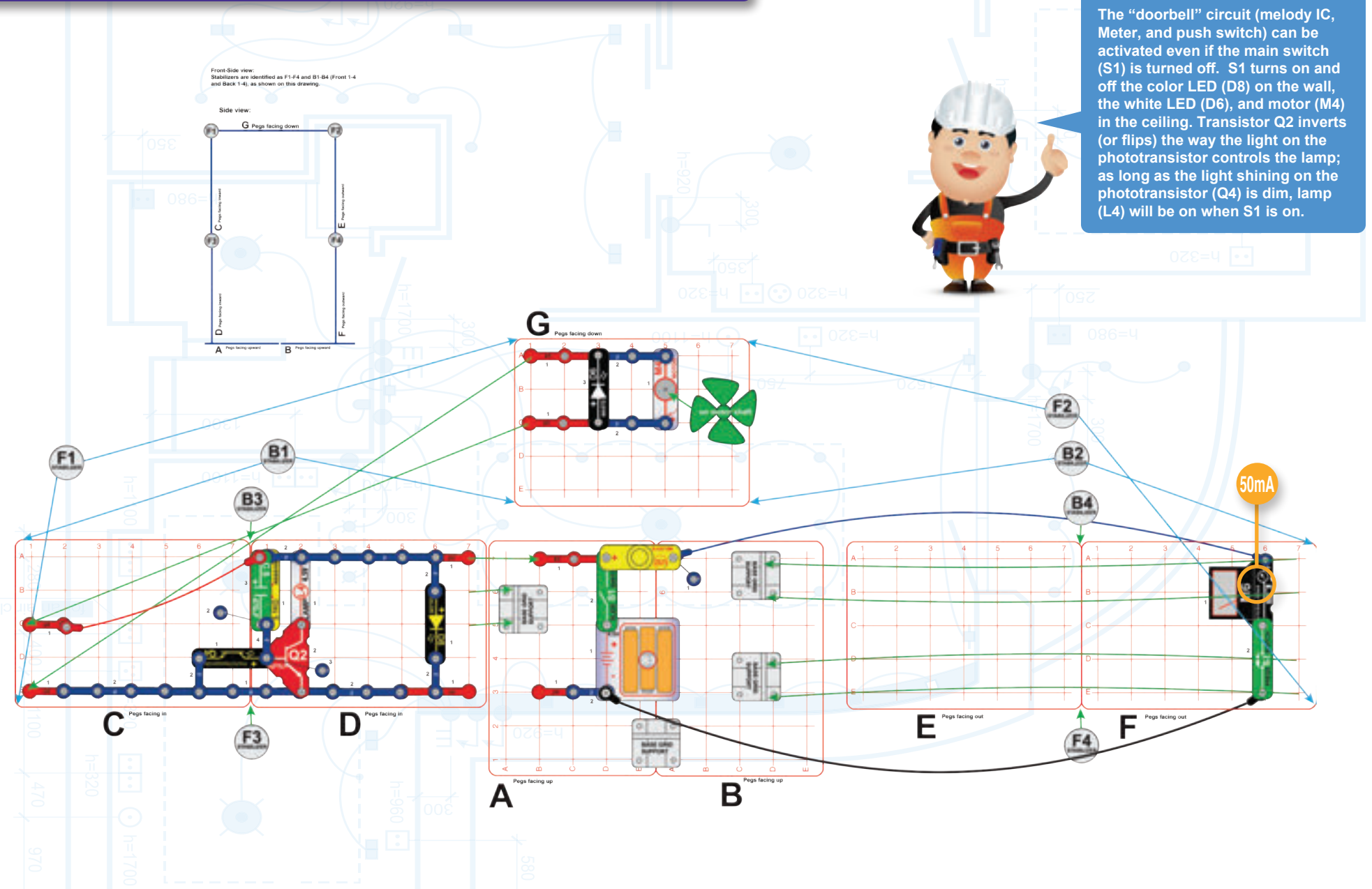

The light covers and slides may be placed on the LEDs (D6 and D8) or lamp (L4) as decoration. Fold the slides as indicated and slide them into the slots on the cover, as shown.



### Assembly (adult supervision recommended):

1. Place base grid supports on base grids A & B.
2. Place parts (except for the jumper wires) on base grids D & F, and install into base grid supports on grids A & B. The pegs should be facing inward on grid D and outward on grid F.
3. Place remaining parts on grids A & B, including the blue and black jumper wires that connect to parts on grid F.
4. Place parts on base grids C & E, and install on top of grids D & F using 4 stabilizers, as shown. The pegs should be facing inward on grid C and outward on grid E. Also connect the red jumper wire.
5. Mount grid G, with pegs oriented down, on top of grids C & E using 4 stabilizers, attaching to the vertical snap wires (V1) on grid C as you do this. Adjust the positions of the stabilizers as needed.
6. Connect the remaining parts on grid G.

Set the meter (M6) to the 50mA scale and turn on the slide switch (S1). The white LED (D6) and color LED (D8) are on while the motor (M4) spins the fan. Push the press switch (S2) to play a doorbell on the melody IC (U32); the meter measures the doorbell current. The lamp (L4) is bright if room is dark, and gets dim as you shine light on phototransistor (Q4); shine a bright light on Q4 to turn off L4. If desired, place the light covers with a slide on any of the LEDs or the lamp.

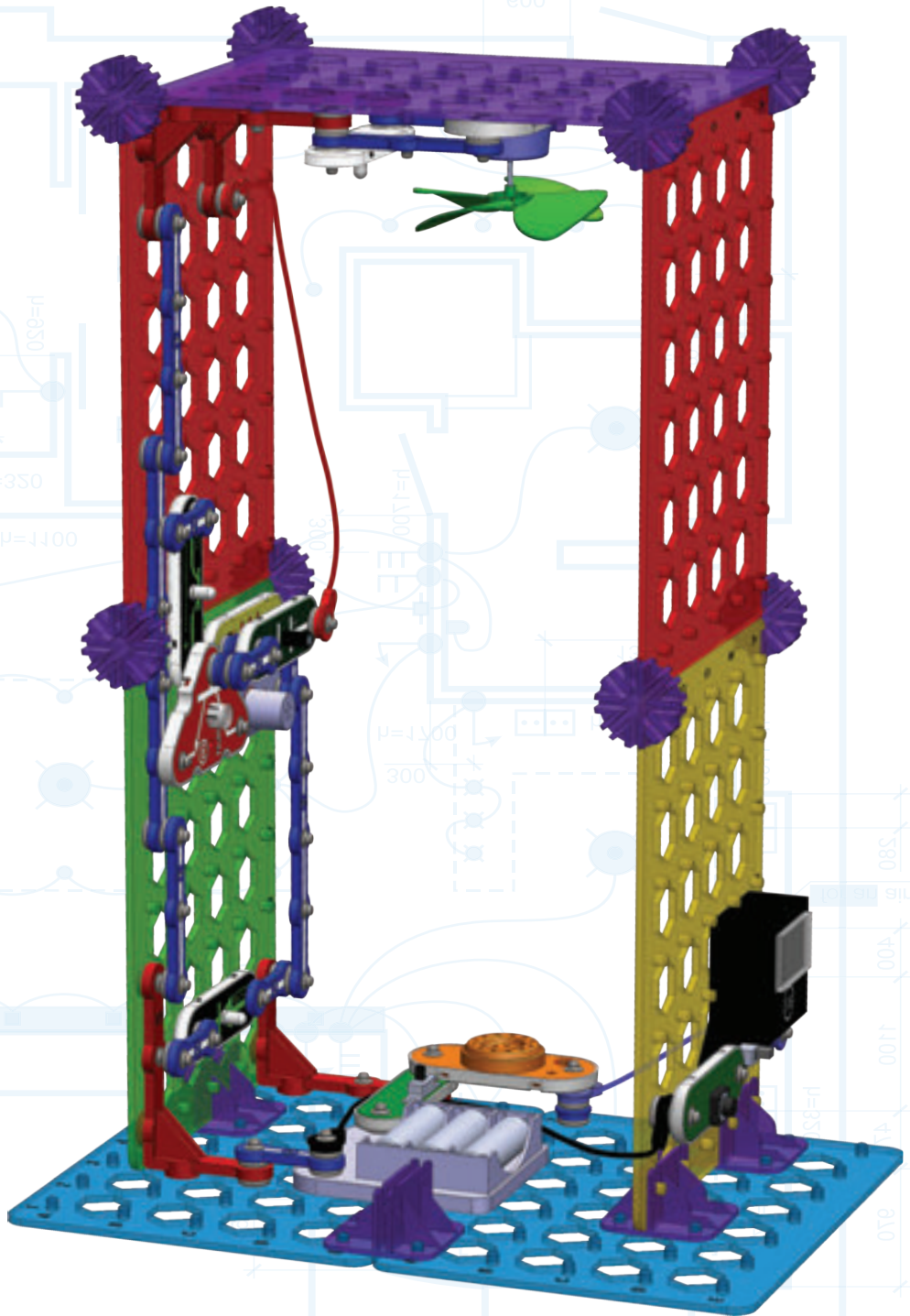



# Project 33 | 2-STORY BUILDING

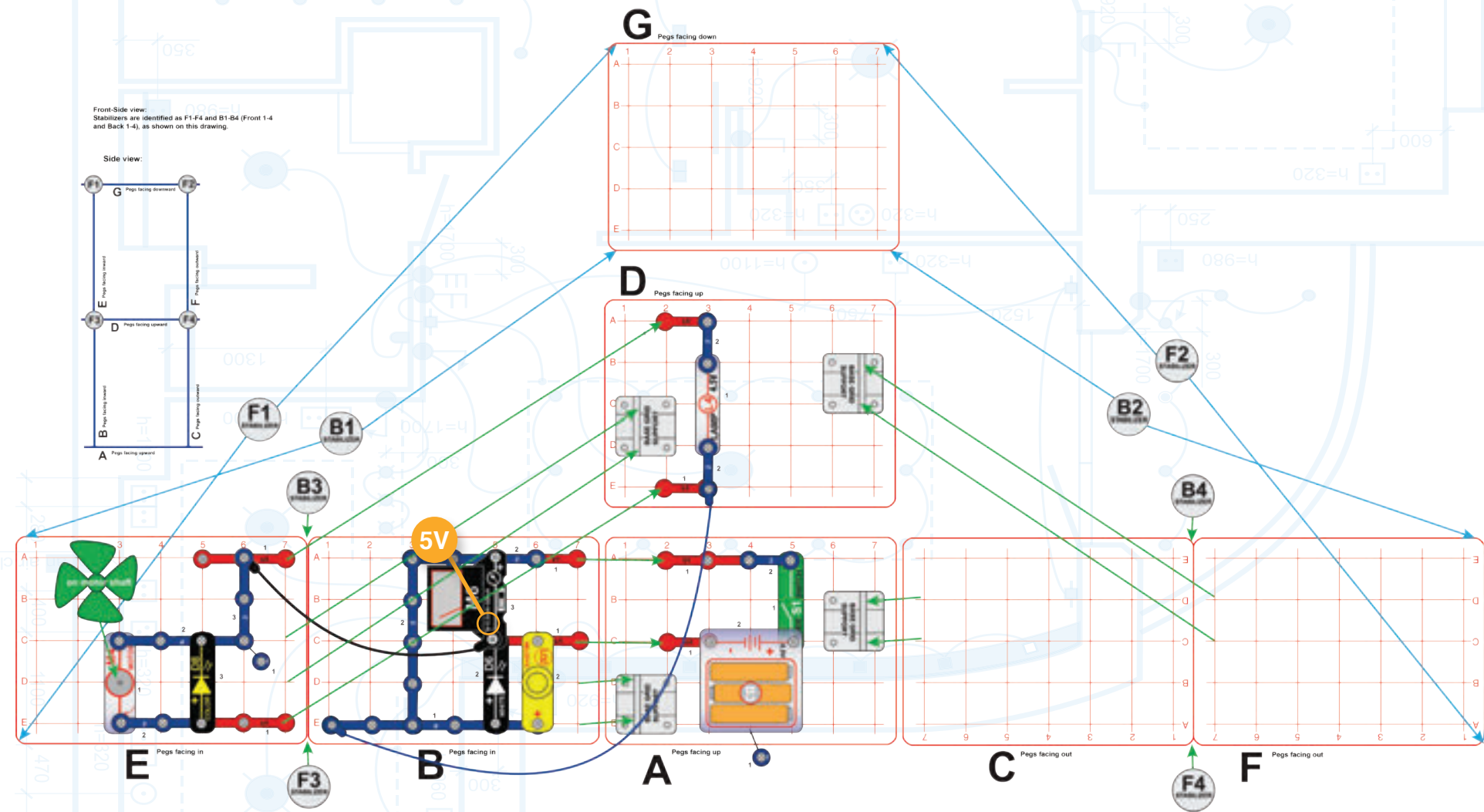

The light covers and slides may be placed on the LEDs (D6 and D8) or lamp (L4) as decoration. Fold the slides as indicated and slide them into the slots on the cover, as shown.



### Assembly (adult supervision recommended):

1. Place base grid supports on base grids A & D.
2. Place parts (except for the jumper wires) on base grid B, and install grids B & C into base grid supports on grid A. The pegs should be facing inward on grids B and C.
3. Place parts (except for the jumper wires) on base grid E, and install grids E & F into base grid supports on grid D. The pegs should be facing inward on grids E and F.
4. Place remaining parts on grids A & D.
5. Mount grids D-E-F assembly on grids B & C using 4 stabilizers, as shown. Adjust the positions of the stabilizers as needed.
6. Mount grid G on grids E & F using 4 stabilizers, as shown. The pegs on grid G should be facing down. Adjust the positions of the stabilizers as needed.
7. Connect the blue and black jumper wires as shown.

Set the meter (M6) to the 5V scale and turn on the slide switch (S1). The lamp (L4) and LEDs (D6 & D8) light, the melody IC plays a tune, the motor (M4) spins the fan, and the meter measures the battery voltage. You can place a slide on one of the light covers and place it on the color LED or lamp. The LEDs, lamp, and melody IC can be re-arranged as desired. *Do not leave the circuit for two minutes because the lamp will be hot.*



# Project 34 | STATIC ELECTRICITY

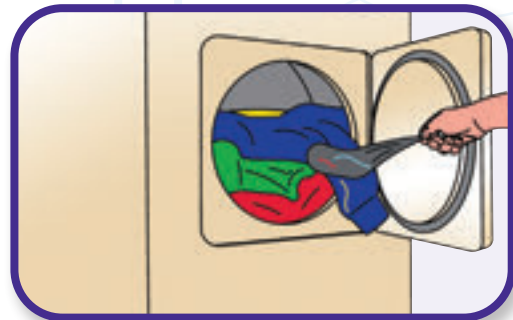

Find clothes that cling together in the dryer, and try to uncling them.



Rub a sweater (wool is best) and see how it clings to other clothes.



Take off a sweater (wool is best) and listen for crackling noises. Try it in a dark room and see if you see sparks. Compare the effects with different fabrics (wool, cotton, etc.).

**Note:** this project works best on a cold dry day. If the weather is humid, the water vapor in the air allows the static electric charge to dissipate, and this project may not work.



Electricity exists everywhere, because electrical charges (electrons and nuclei) are everywhere. But usually the positive and negative charges are so well balanced (or nearly equal) that you don't notice the tiny amount of electrons jumping around. But under certain conditions, like the dry heat inside your house in winter, electrical charges can build up in certain materials and sparks can fly.

These effects are caused by electricity. We call this static electricity because the electrical charges are static (not moving). When electricity flows (usually through wires) we call it an electric current. And electric current flows because of the attraction and repulsion of the charged particles in conducting materials that are physically connected.

Atoms are the smallest amount of matter that can exist independently in our world. All materials are made out of atoms, and they are really, really tiny. Atoms contain a central nucleus (which has a positive electrical charge) that is surrounded by tiny electrons (which are negative electrical charges).

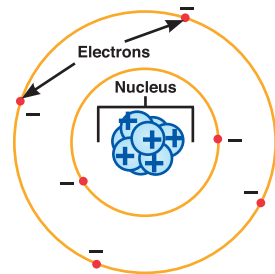

When you rub two materials together, electrons can move from one material to the other, causing a charge imbalance; in other words, one material becomes more negatively charged and the other material becomes more positively charged. When the materials come in close contact again, electrons will flow back to their original material in order to balance things out again.

If you pull two fuzzy sweaters apart in the wintertime, you'll likely hear a sound like static on the radio. Like the thunder that accompanies lightning, this crackling sound is the sound of electrons traveling through the air from one sweater to the other. We call this static electricity.

Static electricity can build up in people too; the shock you sometimes feel when someone touches you is just the sensation of electrons flowing from their body into yours. Sometimes the static electricity (or buildup of electrons) becomes so great that, when it discharges (or flows into something else), it can produce light and even fire (like lightning).



You need a comb (or plastic ruler) and a water faucet for this part. Run the comb through your hair several times then hold it next to a slow, thin stream of water from a faucet. The water will bend towards it. You can also use a plastic ruler. Rub it on your clothes (wool works best).



Rubbing the comb through your hair builds up a static electrical charge on it, which attracts the water.

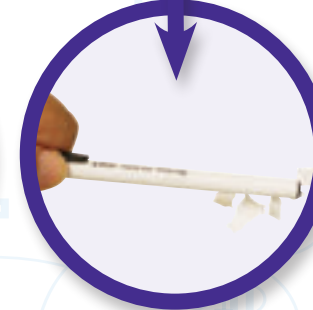

Find a comb (or plastic ruler) and paper. Rip up the paper into small pieces. Run the comb through your hair several times then hold it near the paper pieces to pick them up. You can also use a pen or plastic ruler, rub it on your clothes (wool works best).

Notice how your hair can "stand up" or be attracted to the comb when the air is dry. How will this change if you wet your hair? (Try it.)

Rubbing the comb through your hair pulls electrons from your hair onto the comb. These give the comb a static charge, which attracts the paper.

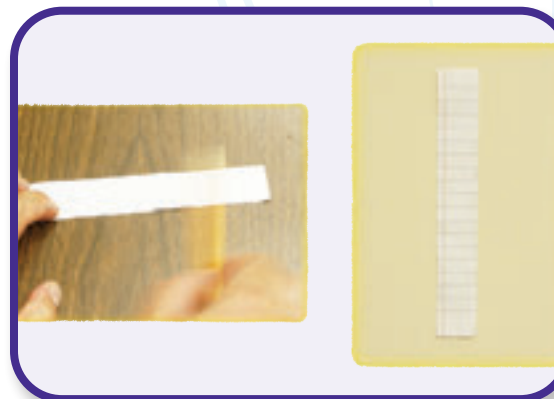

Take a piece of newspaper or other thin paper and rub it vigorously with a sweater or pencil. It will stick to a wall.

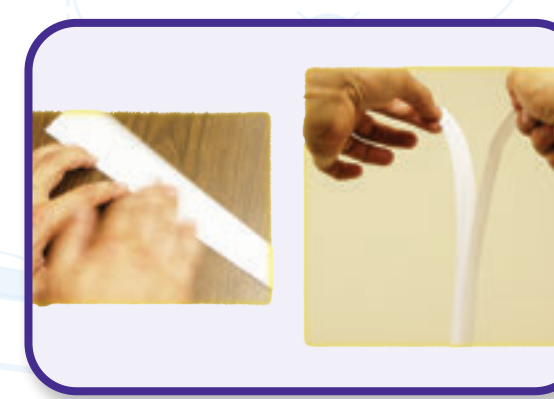

Cut the paper into two long strips, rub them, then hang them next to each other. See if they attract or repel each other.



Rub two balloons on a sweater and hang the rubbed sides next to each other. They repel away. You could also use the balloons to pick up tiny pieces of paper.



# HOW TO USE YOUR BOFFIN

Boffin uses building blocks with snaps to build the different electrical and electronic circuits in the projects. Each block has a function: there are switch blocks, light blocks, battery blocks, different length wire blocks, etc. These blocks are different colors and have numbers on them so that you can easily identify them. The blocks you will be using are shown as color symbols with level numbers next to them, allowing you to easily snap them together to form a circuit.

## For Example:

This is the slide switch, it is green and has the marking **S1** on it. The part symbols in this booklet may not exactly match the appearance of the actual parts, but will clearly identify them.



This is a wire block which is blue and comes in different wire lengths. This one has the number **2**, **3**, **4**, **5**, or **6** on it depending on the length of the wire connection required.



There is also a 1-snap wire that is used as a spacer or for interconnection between different layers.



You need a power source to build each circuit. This is labeled **B3** and requires three (3) 1.5V "AA" batteries (not included).



When installing a battery, be sure the spring is compressed straight back, and not bent up, down, or to one side. Battery installation should be supervised by an adult.

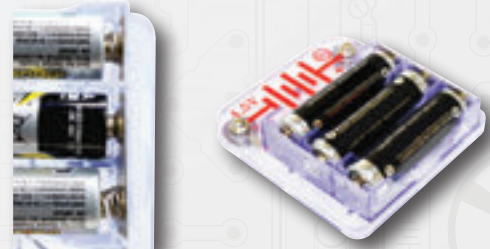

Seven colored plastic base grids are included with this kit to help keep the circuit blocks properly spaced. You will see evenly spaced posts that the different blocks snap into. The base has rows labeled A-E and columns labeled 1-7. The colored grids are interchangeable, so you can use any colors you want in any project.

Next to each part in every circuit drawing is a small number in black. This tells you which level the component is placed at. Place all parts on level 1 first, then all of the parts on level 2, then all of the parts on level 3, etc. Some circuits use the jumper wires to make unusual connections. Just clip them to the metal snaps or as indicated.



When assembling the 3D circuits, the order in which parts are installed is important. In particular, the vertical snap wires (V1) need to be snapped onto the mini base grid first and then the mini base grid is slid into the base grid support as shown below.

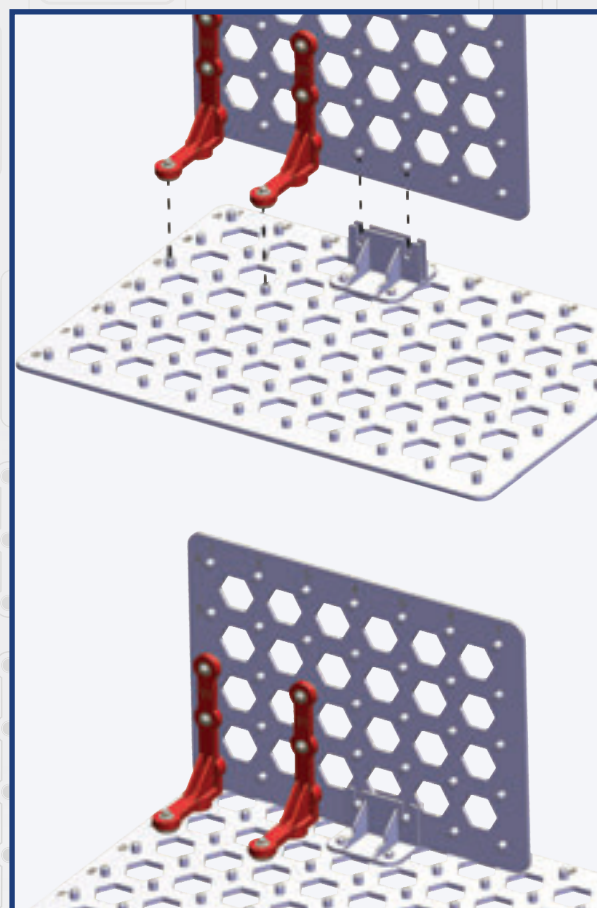

Due to the complex nature of building 3D circuits, the circuit diagrams use special symbols that may need additional clarification. One such example is the symbol for the vertical snap wire (V1). It consists of two parts, the horizontal base and vertical stem. In the illustration below, the base is attached to the large base grid and the stem is attached to the mini base grid. The symbol makes V1 appear as two separate parts, but in reality the symbol is connected at the red circular ends.

Another symbol of note is the base grid support. It is important to pay attention to the orientation of the part in the diagram since it is not symmetrical. The figure below shows the symbol with the narrow channel on top. This corresponds to the 3D rendering showing the base grid support orientation.

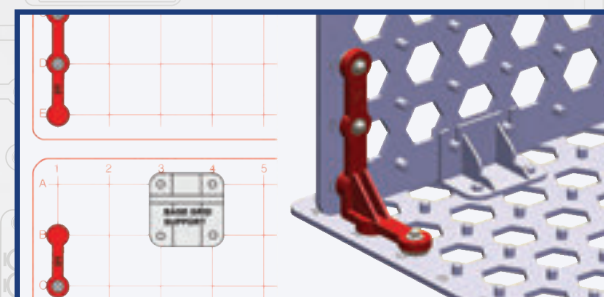

When inserting the base grid into the base grid support, it is a good idea to insert an area on the base grid that doesn't have raised letters or numbers. The raised text can interfere with the insertion or cause a tight fit between the base grid and base grid support.



To install the base grid support onto the base grid, align the holes of the support with the base grid pegs in the desired location on the base grid and press down firmly on the base grid support. Make sure that the base grid support is fully seated on the base grid.

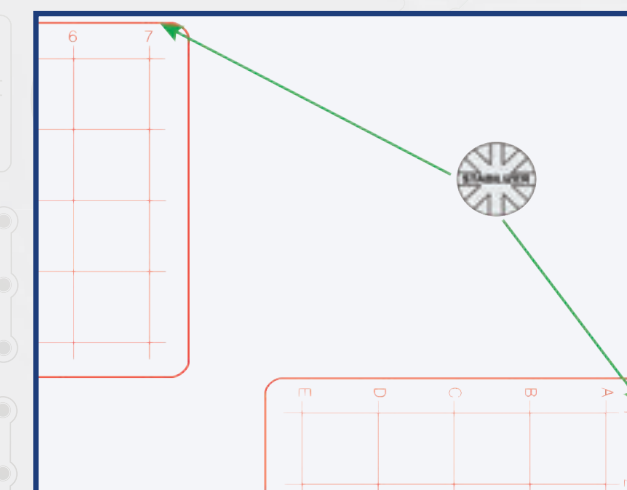
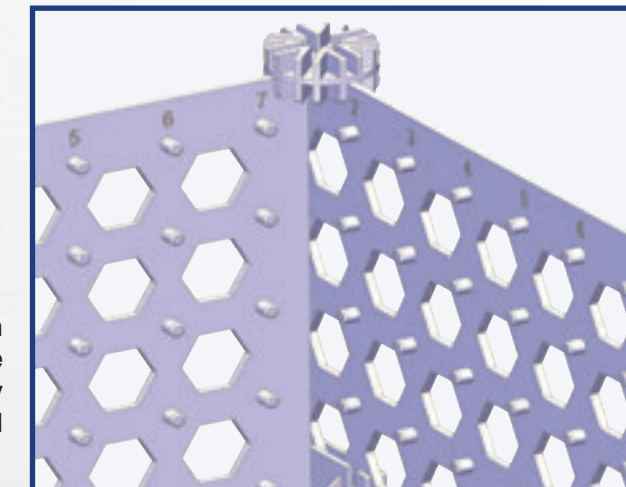

The stabilizer is used to connect base grids on their corners or edges. With eight slots, the stabilizer allows the base grids to be mounted in increments of 45 degrees.

To attach the stabilizer to the base grid, simply align the desired grooves in the stabilizer with the edges of the base grids and press down. The figure below shows how the stabilizer symbol is presented in the manual and the 3D rendering of the stabilizer mounted to two base grids.

**Note:** go to [www.boffin.cz](http://www.boffin.cz) for interactive 3D pictures to help with building the 3D circuits.

# HOW TO USE YOUR BOFFIN

The light covers and slides may be placed on the LEDs (D6 and D8) or lamp (L4) as decoration. Fold the slides as indicated and slide them into the slots on the cover, as shown.

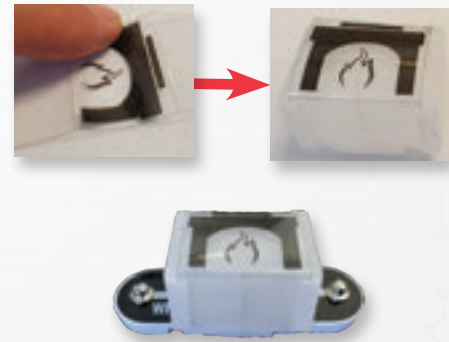

The fiber optic festive tree can be mounted on the LEDs (D6 and D8) to enhance their light effects. The fiber optic festive tree must be mounted using the mounting base, as shown.



The clear motor (M4) will often have the wind fan mounted on it; simply push the fan onto the shaft. To remove it, push up on it with a screwdriver or your thumbs, being careful not to break it.



**Note:** while building the projects, be careful not to accidentally make a direct connection across the battery holder (a "short circuit"), as this may damage and/or quickly drain the batteries.

## ⚠ Batteries:

- Use only 1.5V AA type, alkaline batteries (not included).
- Insert batteries with correct polarity.
- Non-rechargeable batteries should not be recharged. Rechargeable batteries should only be charged under adult supervision, and should not be recharged while in the product.
- Do not connect batteries or battery holders in parallel.
- Do not mix old and new batteries.
- Do not mix alkaline, standard (carbon-zinc), or rechargeable batteries.
- Remove batteries when they are used up.
- Do not short circuit the battery terminals.
- Never throw batteries in a fire or attempt to open its outer casing.
- Batteries are harmful if swallowed, so keep away from small children.
- When installing a battery, be sure the spring is compressed straight back, and not bent up, down, or to one side.
- Battery installation should be supervised by an adult.

# PARTS LIST (COLORS AND STYLES MAY VARY)

**Important:** If any parts are missing or damaged, **DO NOT RETURN TO RETAILER.** Call toll-free +420 284 000 111 or e-mail us at: info@cqe.cz. Customer Service: ConQuest entertainment a. s., Kolbenova 961, 198 00, Praha 9, www.boffin.cz • You may order additional / replacement parts at www.toy.cz

Qty.	ID	Name	Symbol	Part #	Qty.	ID	Name	Symbol	Part #
3	1	1- Snap Wire		6SC01	1		Jumper Wire, Black		6SCJ1
6	2	2- Snap Wire		6SC02	1		Jumper Wire, Red		6SCJ2
3	3	3- Snap Wire		6SC03	2		Jumper Wire, Blue		6SCJ4
1	4	4- Snap Wire		6SC04	1	L4	Lamp, 4.5V		6SCL4
1	5	5- Snap Wire		6SC05	2		Light Cover		6SCLCOV
1	6	6- Snap Wire		6SC06	1		Slides for Light Cover Set of 3		6SCLCOVSL
1	B3	Battery Holder - uses three (3) 1.5V type "AA" (not Included)		6SCB3	1	M4	Motor		6SCM4
2		Base Grid Mini (7.7" x 5.5") Red Tint		6SCBGMRD	1		Green Fan		6SCM4B
1		Base Grid Mini (7.7" x 5.5") Yellow Tint		6SCBGMYL	1	M6	Meter		6SCM6
1		Base Grid Mini (7.7" x 5.5") Green Tint		6SCBGMGR	1	Q2	NPN Transistor		6SCQ2
2		Base Grid Mini (7.7" x 5.5") Blue Tint		6SCBGMBL	1	Q4	Phototransistor		6SCQ4
1		Base Grid Mini (7.7" x 5.5") Purple Tint		6SCBGMPL	1	R3	5.1kΩ Resistor		6SCR3
1		Base Grid Support Purple Tint		6SCBGSUPPR	1	S1	Slide Switch		6SCS1
1	C5	470μF Capacitor		6SCC5	1	S2	Press Switch		6SCS2
1	D6	White LED		6SCD6	10		Stabilizer Purple Tint		6SCSTABPR
1	D8	Color LED		6SCD8	1	U32	Melody IC		6SCU32
1		Mounting Base		6SCFMB	4	V1	Vertical Snap Wire		6SCV1
1		Fiber Optic Festive Tree		6SCFT2					

# ABOUT YOUR BOFFIN PARTS

## BASE GRID

The **base grids** are platforms for mounting parts and wires. They function like the printed circuit boards used in most electronic products, or like how the walls are used for mounting the electrical wiring in your home. The base grids can be placed together to form larger grids.

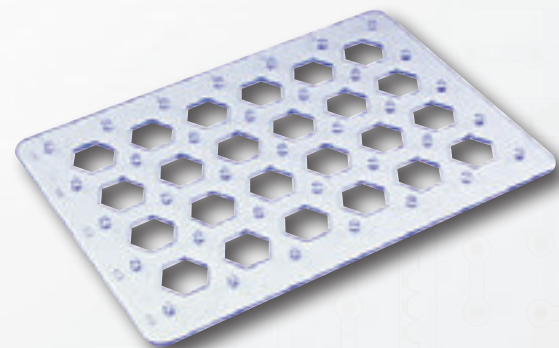

## SNAP WIRES, VERTICAL SNAP WIRES, & JUMPER WIRES

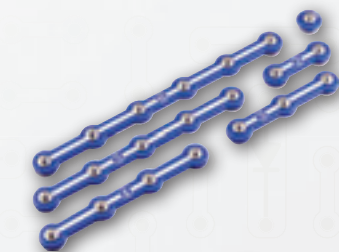

The blue **snap wires** are wires used to connect components. They are used to transport electricity and do not affect circuit performance. They come in different lengths to allow orderly arrangement of connections on the base grid.



The **vertical snap wires (V1)** make connections between two dimensions, allowing electricity to go up a wall.

## SLIDE & PRESS SWITCHES

The **slide & press switches (S1 & S2)** connect (pressed or "ON") or disconnect (not pressed or "OFF") the wires in a circuit. When ON they have no effect on circuit performance. Switches turn on electricity just like a faucet turns on water from a pipe.

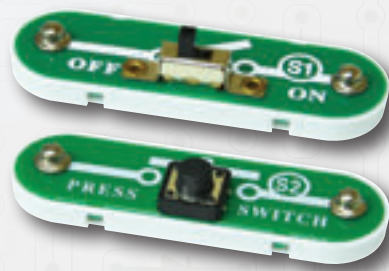

Slide & Press Switches (S1 & S2)

The **jumper wires** (red, black, & blue) make flexible connections for times when using the snap wires would be difficult. They also are used to make connections off the base grid.

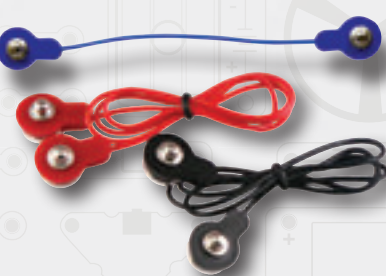

Wires transport electricity just like pipes are used to transport water. The colorful plastic coating protects them and prevents electricity from getting in or out.

*(Part designs are subject to change without notice).*

## BATTERY HOLDER

The **batteries (B3)** produce an electrical voltage using a chemical reaction. This "voltage" can be thought of as electrical pressure, pushing electricity through a circuit just like a pump pushes water through pipes. This voltage is much lower and much safer than that used in your house wiring. Using more batteries increases the "pressure", therefore, more electricity flows.



Battery Holder (B3)

## RESISTORS

Resistors "resist" the flow of electricity and are used to control or limit the current in a circuit. This set includes a **5.1kΩ resistor (R3)** ("k" symbolizes 1,000, so R3 is really 5,100Ω). Materials like metal have very low resistance (<1 Ω), while materials like paper, plastic, and air have near-infinite resistance. Increasing circuit resistance reduces the flow of electricity.



5.1kΩ Resistor (R3)

## CAPACITOR

The **470μF capacitors (C5)** can store electrical pressure (voltage) for periods of time. This storage ability allows them to block stable voltage signals and pass changing ones. Capacitors are used for filtering and delay circuits.



Capacitor (C5)

## LEDs

The **white and color LEDs (D6 & D8)** are light emitting diodes, and may be thought of as a special one-way light bulbs. In the "forward" direction, (indicated by the "arrow" in the symbol) electricity flows if the voltage exceeds a turn-on threshold brightness then increases. The color LED contains red, green, and blue LEDs, with a micro-circuit controlling them. A high current will burn out an LED, so the current must be limited by other components in the circuit (Boffin LEDs have internal resistors added, to protect them in case you make wiring mistakes). LEDs block electricity in the "reverse" direction.

LEDs (D6 & D8)



## LAMP

A light bulb, such as in the **4.5V lamp (L4)**, contains a special thin high-resistance wire. When a lot of electricity flows through, this wire gets so hot it glows bright. Voltages above the bulb's rating can burn out the wire.



4.5V Lamp (L4)

## SOUND MODULE

The **melody IC (U32)** contains a specialized sound-generation integrated circuit (IC), a small speaker, and a few supporting components. The IC has a recording of the melody, which it makes into an electrical signal for the speaker. The speaker converts the signal into mechanical vibrations. The vibrations create variations in air pressure, which travel across the room. You "hear" sound when your ears feel these air pressure variations.



## TRANSISTORS

The **NPN transistor (Q2)** is a component that uses a small electric current to control a large current, and are used in switching, amplifier, and buffering applications. Transistors are easy to miniaturize, and are the main building blocks of integrated circuits including the microprocessor and memory circuits in computers.



NPN Transistor (Q2)

The **phototransistor (Q4)** is a transistor that uses light to control electric current.



Phototransistor (Q4)

# ABOUT YOUR BOFFIN PARTS

## METER

The **meter (M6)** is an important measuring device. You use it to measure the voltage (electrical pressure) and current (how fast electricity is flowing) in a circuit.



Meter (M6)

The meter measures voltage when connected in parallel to a circuit and measures the current when connected in series in a circuit.

This meter has one voltage scale (5V) and two current scales (0.5mA and 50mA). These use the same meter but with internal components that scale the measurement into the desired range. Sometimes external components will be used to change the meter scale to one not shown.

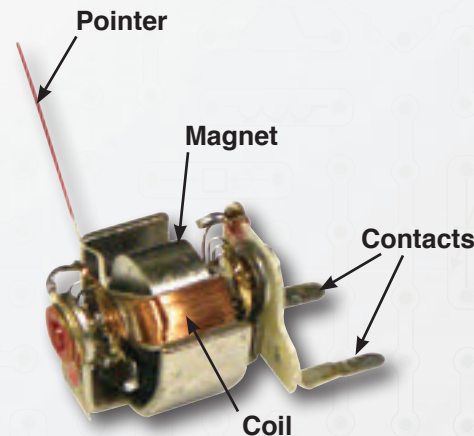

Inside the meter there is a fixed magnet and a moveable coil around it. As current flows through the coil, it creates a magnetic field. The interaction of the two magnetic fields causes the coil (connected to the pointer) to move (deflect).

## MOTOR

The **motor (M4)** converts electricity into mechanical motion. An electric current through the motor will turn the shaft.

It can also be used as a generator, since it produces an electric current when the shaft is turned.



Motor (M4)

How does electricity turn the shaft in the motor? The answer is magnetism. Electricity is closely related to magnetism, and an electric current flowing in a wire has a magnetic field similar to that of a very, very tiny magnet. Inside the motor is a coil of wire with many loops. If a large electric current flows through the loops, the magnetic effects become concentrated enough to move the coil. The motor has a magnet inside, so as the electricity moves the coil to align it with the permanent magnet, the shaft spins.

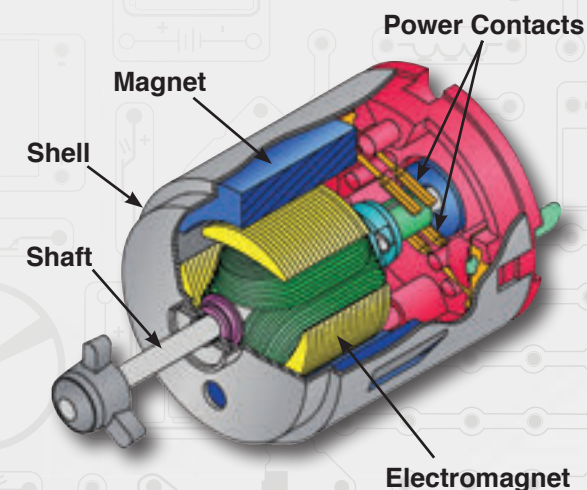

When used as a generator, wind or water turns the shaft. A coil of wire is on the shaft, and as it spins past the permanent magnet an electric current is created in the wire.



Fan

# DO'S AND DON'TS OF BUILDING CIRCUITS

After building the circuits given in this booklet, you may wish to experiment on your own. Use the projects in this booklet as a guide, as many important design concepts are introduced throughout them. Every circuit will include a power source (the batteries), a resistance (which might be a resistor, melody IC, LED (which has an internal protection resistor), motor, lamp, etc.), and wiring paths between them and back. **You must be careful not to create "short circuits" (very low-resistance paths across the batteries, see examples below) as this will damage components and/or quickly drain your batteries. ConQuest entertainment a.s. is not responsible for parts damaged due to incorrect wiring.**

## Here are some important guidelines:

**ALWAYS USE EYE PROTECTION WHEN EXPERIMENTING ON YOUR OWN.**

**ALWAYS** include at least one component that will limit the current through a circuit, such as a resistor, melody IC, an LED (which has an internal protection resistor), lamp, or motor.

**ALWAYS** use switches in conjunction with other components that will limit the current through them. Failure to do so will create a short circuit and/or damage those parts.

**ALWAYS** disconnect your batteries immediately and check your wiring if something appears to be getting hot.

**ALWAYS** check your wiring before turning on a circuit.

**NEVER** connect to an electrical outlet in your home in any way.

**NEVER** leave a circuit unattended when it is turned on.

For all of the projects given in this book, the parts may be arranged in different ways without changing the circuit. For example, the order of parts connected in series or in parallel does not matter — what matters is how combinations of these sub-circuits are arranged together.

**3D Construction:** Motors or other parts that produce motion (which you may have from other Boffin sets) should only be mounted overhead or on walls with great care, as the vibrations they produce could cause them to fall. The circuits in this set have been checked with the parts shown in them.

**Warning to Boffin owners:** Do not connect additional voltage sources from other sets, or you may damage your parts. Contact ConQuest entertainment a.s. if you have questions or need guidance.

## Examples of SHORT CIRCUITS - NEVER DO THESE!!!

Placing a 3-snap wire directly across the batteries is a **SHORT CIRCUIT**.

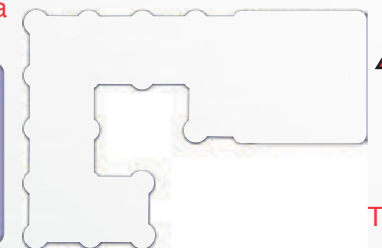
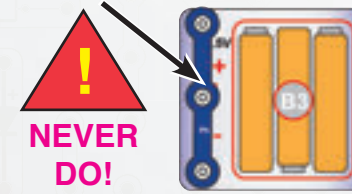

When the slide switch (S1) is turned on, this large circuit has a **SHORT CIRCUIT** path (as shown by the arrows). The short circuit prevents any other portions of the circuit from ever working.

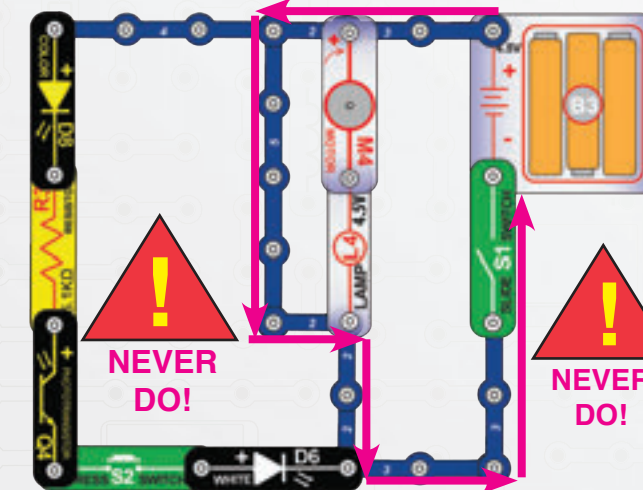

You are encouraged to tell us about new programs and circuits you create.

If they are unique, we will post them with your name and state on our website at: [www.toy.cz](http://www.toy.cz). Send your suggestions to ConQuest entertainment: [info@toy.cz](mailto:info@toy.cz).

**WARNING: SHOCK HAZARD** - Never connect Boffin to the electrical outlets in your home in any way!

## TROUBLESHOOTING (ADULT SUPERVISION RECOMMENDED)

ConQuest entertainment a.s. is not responsible for parts damaged due to incorrect wiring.

### Basic troubleshooting:

- Most circuit problems are due to incorrect assembly, always double-check that your circuit exactly matches the drawing for it.
- Be sure that parts with positive/negative markings are positioned as per the drawing.
- Be sure that all connections are securely snapped.
- Try replacing the batteries.
- For circuits using the phototransistor (Q4), if the alarm is always activated then it could be getting triggered by other lights in the room; try turning them off or moving to a different room.

If you suspect you have damaged parts, you can follow this procedure to systematically determine which ones need replacing:

- White LED (D6), color LED (D8), lamp (L4), melody IC (U32), motor (M4), and battery holder (B3):** Place batteries in holder. Place the lamp directly across the battery holder, it should light. Place the white LED, and color LED directly across the battery holder (LED + to battery +), the LED should light. Similarly, place the melody IC directly across the battery holder (+ to +), it should make sound. Place the motor directly across the battery holder, the shaft should spin (you can place the green fan on the shaft so the spinning is easy to see). If none work, then replace your batteries and repeat, if still bad then the battery holder is damaged.

- Jumper wires:** Use this mini-circuit to test each jumper wire, the LED should light.

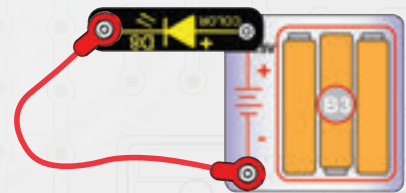

- Snap wires:** Use this mini-circuit to test each of the snap wires, one at a time. The LED should light.

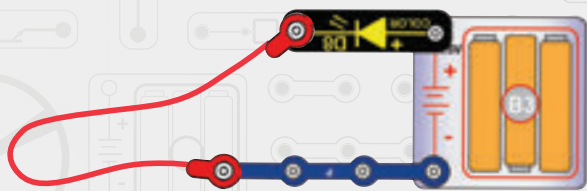

- Vertical snap wires (V1):** Use this mini-circuit to test each of the vertical snap wires, one at a time. The LED should light.

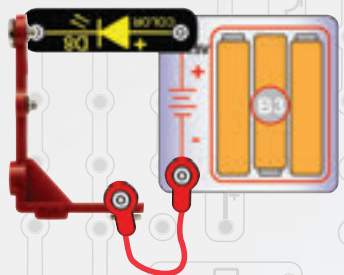

## TROUBLESHOOTING (ADULT SUPERVISION RECOMMENDED)

- Slide switch (S1) and press switch (S2):** Build project 1 but replace the meter (M6) with a 3-snap wire; if the color LED (D8) doesn't light then the slide switch is bad. Replace the slide switch with the press switch to test it.
- Phototransistor (Q4) and 5.1kΩ resistor (R3):** Build project 26 and vary the amount of light shining on the phototransistor. The brighter the light on the phototransistor, the brighter the color LED (D8) should be. Then replace the phototransistor with the 5.1kΩ resistor; the color LED should light dimly.

- NPN transistor (Q2):** Use project part D of project 22; the white LED (D6) should be on only if the press switch (S2) is pushed. If otherwise then Q2 is damaged.

- Meter (M6):** Build project 1.
  - Set the meter to the 50mA scale and turn on the switch. The meter current should be above 0 but less than 5.
  - Set the meter to the 1mA scale and turn on the switch. The reading should be over maximum.
  - Replace the white LED (D6) with a 3-snap wire. Set the meter to the 5V scale and turn on the switch. The meter should read at least 2.5.
- 470m F Capacitor (C5):** Use project 13; the meter current should drop as the capacitor charges up, as described in that project.

### Notes

## SC- MyH7 Parts Layout

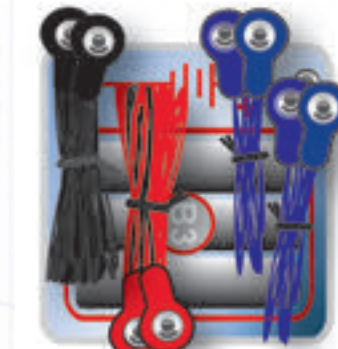
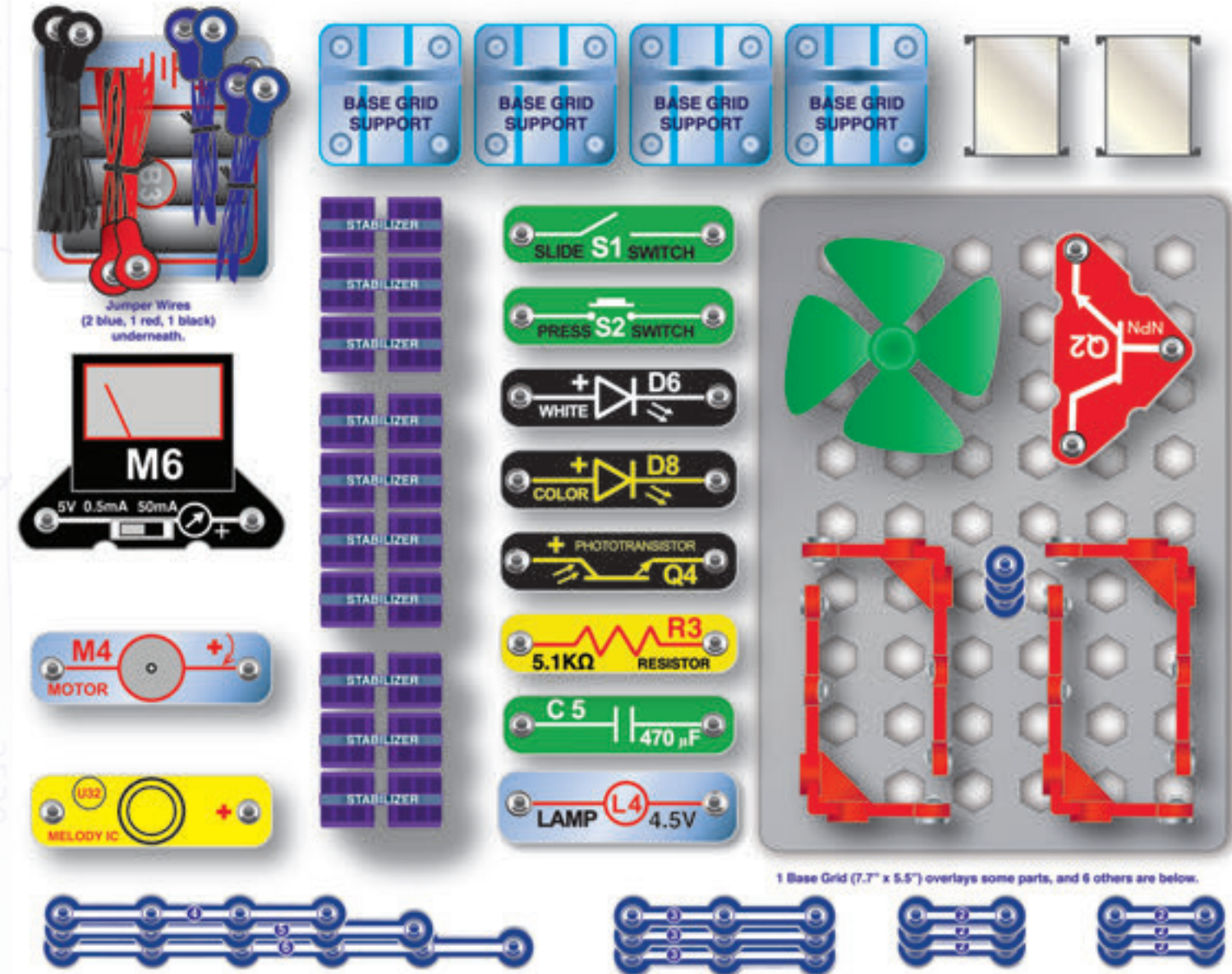

Jumper Wires  
(2 blue, 1 red, 1 black)  
underneath.

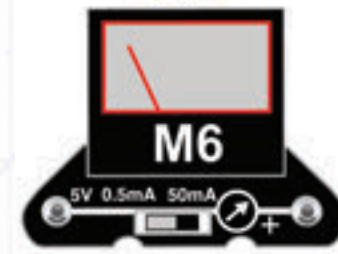

M6  
5V 0.5mA 50mA



M4  
MOTOR



MELODY IC

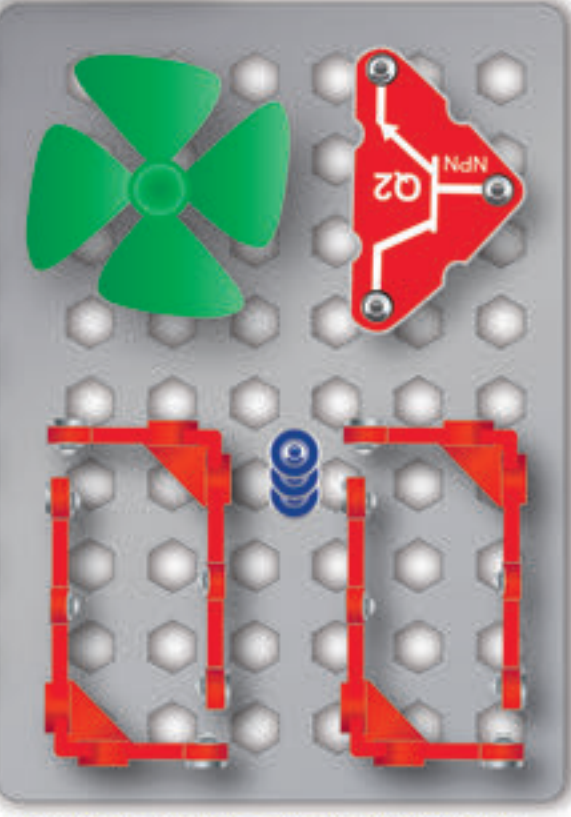

1 Base Grid (7.7" x 5.5") overlays some parts, and 6 others are below.

Note: A complete parts list is on page 54 in this manual.

Important: If parts are missing or damaged, DO NOT RETURN TO RETAILER. Call +420 284 000 111 or e-mail: info@cqe.cz.





WWW.TOY.CZ

**ConQuest entertainment a.s.**

Kolbenova 961, 198 00 Praha 9

[www.boffin.cz](http://www.boffin.cz)

[info@boffin.cz](mailto:info@boffin.cz)