

Flash frequency



WARNING: This toy produces flashes that may trigger epilepsy in sensitised individuals.

Only for use by children aged 8 years and older. Not suitable for children and under 8 years due to small parts which could cause a choking hazard.

Light bulb warning



WARNING! Hot surface, do not touch bulb.



Overview: Amendments of the new EN 62115: 2020/A11:2020 concerning batteries and LEDs

Batteries

Small batteries

Batteries that fit wholly within the small parts cylinder (as specified in §8.2 of EN 71-1:2014+A1:2018) shall not be removable without the aid of a tool.

For parts of electric toys containing batteries, where the part fits wholly within the small parts cylinder (as specified in 8.2 of EN 71-1:2014+A1:2018), batteries shall not be accessible without the aid of a tool.

Other batteries

Batteries shall not be removable without the aid of a tool unless the security of the battery compartment cover is adequate.

Compliance is checked by inspection and by the following test. An attempt is made to gain access to the battery compartment by manual means. It shall not be possible to open the cover unless at least two independent movements have to be applied simultaneously.

The electric toy is placed on a horizontal steel surface.

A cylindrical metallic mass of 1 kg, having a diameter of 80 mm, is dropped from a height of 100 mm so that its flat face falls onto the electric toy. The test is carried out once with the cylindrical metallic mass striking the electric toy in the most unfavourable place. The battery compartment shall not become open.

- ▶ So all batteries need a battery cover in future, which complies with the specifications above.

Batteries supplied with the toy

Primary batteries supplied with electric toys shall comply with the relevant parts of the IEC 60086 series.

- ▶ A Pass Test Report is needed.

Secondary batteries supplied with electric toys shall comply with IEC 62133.

- ▶ A Pass Test Report is needed.

Battery compartment fasteners

If screws or similar fasteners are used to secure a door or cover providing access to the battery compartment, the screw or similar fastener shall be captive to ensure that they remain with the door, cover or equipment.

Compliance is checked by inspection and by the following test after the battery door or cover is opened. A force of 20N is applied to the screw or similar fastener without jerks for a duration of 10s in any direction.

The screw or similar fastener shall not become separated from the door, cover or equipment.

Light-emitting diodes

The emission from electric toys incorporating LEDs shall not exceed the following limits:

- 0,01 Wm⁻² when assessed at 10 mm from the LED front for accessible emissions with wavelengths of < 315 nm;
- 0,01 Wsr⁻¹ or 0,25 Wm⁻² when assessed at 200 mm, for accessible emissions with wavelengths of 315 nm ≤ λ < 400 nm;

- 0,04 Wsr⁻¹ or the AEL specified in Tables E.2 or E.3 assessed at 200 mm for accessible emissions with wavelengths of 400 nm ≤ λ < 780 nm;
- 0,64 Wsr⁻¹ or 16 Wm⁻² when assessed at 200 mm for accessible emissions with wavelengths of 780 nm ≤ λ < 1 000 nm;
- 0,32 Wsr⁻¹ or 8 Wm⁻² when assessed at 200 mm for accessible emissions with wavelengths of 1 000 nm ≤ λ < 3 000 nm.

LED data sheets

As the technical data sheet is essential for compliance with this standard, it shall be developed following the measurement criteria of condition A or condition B of CIE 127. The technical data sheet shall indicate that it has been created using the CIE 127 measurement methods and as a minimum include:

- the luminous intensity in candela or radiant intensity in Watts per steradian as a function of forward current,
- the angle,
- the peak wavelength,
- the spectral emission bandwidth,
- the date of issue and the revision number.

- ▶ So all LEDs need a LED data sheet in future, which includes the specifications above.

159
PROJECTS

60
PARTS



Table of Contents

Basic Troubleshooting	1	Advanced Troubleshooting	10
Parts List	2, 3	Project Listings	11, 12
How to Use Boffin	4, 5	Projects 1 - 159	13–84
About Your Boffin Parts	6, 7	Going Further	85
Introduction to Electricity	8	Other Boffin Products	86
DOs and DON'Ts of Building Circuits	9		



WARNING: SHOCK HAZARD - Never connect Boffin to the electrical outlets in your home in any way!



WARNING: CHOKING HAZARD - Small parts. Not for children under 3 years.

Conforms to all applicable U.S. government requirements and CAN ICES-3 (B)/NMB-3 (B).

Basic Troubleshooting

1. Most circuit problems are due to incorrect assembly, always double-check that your circuit exactly matches the drawing for it.
2. Be sure that parts with positive/negative markings are positioned as per the drawing.
3. Be sure that all connections are securely snapped.
4. Try replacing the batteries.
5. For circuits using mirrors and the phototransistor (Q4), if the alarm is always activated then it could be getting triggered by other lights in the room; try turning them off or moving to a different room.

ConQuest entertainment is not responsible for parts damaged due to incorrect wiring.

Note: If you suspect you have damaged parts, you can follow the Advanced Troubleshooting procedure on page 8 to determine which ones need replacing.

WARNING: Always check your wiring before turning on a circuit. Never leave a circuit unattended while the batteries are installed. Never connect additional batteries or any other power sources to your circuits. Discard any cracked or broken parts.

Adult Supervision: Because children's abilities vary so much, even with age groups, adults should exercise discretion as to which experiments are suitable and safe (the instructions should enable supervising adults to establish the experiment's suitability for the child).

Make sure your child reads and follows all of the relevant instructions and safety procedures, and keeps them at hand for reference.

This product is intended for use by adults and children who have attained sufficient maturity to read and follow directions and warnings.

Never modify your parts, as doing so may disable important safety features in them, and could put your child at risk of injury.

CAUTION: High intensity light. Do not look directly at the white LED (D6).











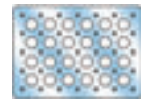

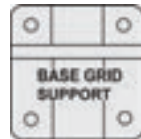

Batteries:

- Do not mix old and new batteries.
- Do not mix alkaline, standard (carbon-zinc), or rechargeable (nickel-cadmium) batteries.
- Remove batteries when they are used up.
- Do not short circuit the battery terminals.
- Never throw batteries in a fire or attempt to open its outer casing.
- Batteries are harmful if swallowed, so keep away from small children.
- Use only 1.5V AA type, alkaline batteries (not included).
- Insert batteries with correct polarity.
- Non-rechargeable batteries should not be recharged. Rechargeable batteries should only be charged under adult supervision, and should not be recharged while in the product.
- Do not connect batteries or battery holders in parallel.

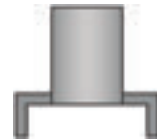



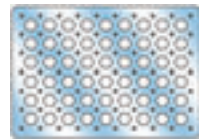
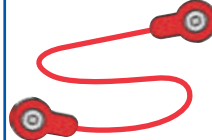





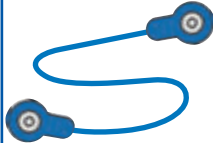

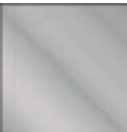

Parts List (Colors and styles may vary) Symbols and Numbers

Important: If any parts are missing or damaged, **DO NOT RETURN TO RETAILER.** Call toll-free +420 284 000 111 or e-mail us at: info@cqe.cz, Customer Service: ConQuest entertainment a. s. Kolbenova 961, 198 00, Praha 9, www.boffin.cz

Qty.	ID	Name	Symbol	Part	Qty.	ID	Name	Symbol	Part
☐3	①	1-Snap Wire		6SC01	☐4		Base Grid Mini (7.7" x 5.5")		6SCBGM
☐6	②	2-Snap Wire		6SC02	☐4		Base Grid Support		6SCBGSUP
☐3	③	3-Snap Wire		6SC03	☐1	Ⓓ6	White LED		6SCD6
☐1	④	4-Snap Wire		6SC04	☐1	Ⓓ8	Color LED		6SCD8
☐1	⑤	5-Snap Wire		6SC05	☐1		Q4 Attachment		6SCFMB
☐1	⑥	6-Snap Wire		6SC06	☐1		3D Color Glasses		6SCG3DC
☐1	Ⓑ3	Battery Holder - uses three (3) 1.5V type "AA" (not Included)		6SCB3	☐1		Jumper Wire (Black)		6SCJ1
☐1		Base Grid (11.0" x 7.7")		6SCBG	☐1		Jumper Wire (Red)		6SCJ2

Parts List (Colors and styles may vary) Symbols and Numbers

Important: If any parts are missing or damaged, **DO NOT RETURN TO RETAILER.** Call toll-free +420 284 000 111 or e-mail us at: info@cqe.cz, Customer Service: ConQuest entertainment a. s. Kolbenova 961, 198 00, Praha 9, www.boffin.cz

Qty.	ID	Name	Symbol	Part	Qty.	ID	Name	Symbol	Part
☐2		Jumper Wire (Blue)		6SCJ4	☐1	ⓂR3	Resistor 5.1K Ohms		6SCR3
☐1		Lined Lens LED Attachment		6SCLENS	☐1	ⓂS1	Slide Switch		6SCS1
☐2		Mirror (2.0" x 2.0" or similar)		6SCMIRROR	☐1	ⓂS2	Press Switch		6SCS2
☐2		Mirror Mounting Base		6SCMBASE	☐6		Stabilizer		6SCSTAB
☐2		Spring for Mirror Mounting Base		6SCMSPRG	☐1	ⓂU30	Light Tunnel		6SCU30
☐1		Projector LED Attachment		6SCPROJ	☐6	ⓂV1	Vertical Snap Wire		6SCV1
☐1	ⓂQ2	NPN Transistor		6SCQ2	☐1	ⓂW1	Horn		6SCW1
☐1	ⓂQ4	Phototransistor		6SCQ4	You may order additional / replacement parts at our website: www.toy.cz				

How to Use Boffin

Boffin uses building blocks with snaps to build the different electrical and electronic circuits in the projects. Each block has a function: there are switch blocks, light blocks, battery blocks, different length wire blocks, etc. These blocks are different colors and have numbers on them so that you can easily identify them. The blocks you will be using are shown as color symbols with level numbers next to them, allowing you to easily snap them together to form a circuit.

For Example:

This is the slide switch, it is green and has the marking **S1** on it. The part symbols in this booklet may not exactly match the appearance of the actual parts, but will clearly identify them.



This is a wire block which is blue and comes in different wire lengths. This one has the number **2**, **3**, **4**, **5**, or **6** on it depending on the length of the wire connection required.

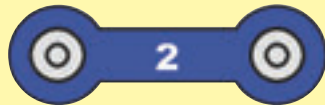

There is also a 1-snap wire that is used as a spacer or for interconnection between different layers.



You need a power source to build each circuit. This is labeled **B3** and requires three (3) 1.5V "AA" batteries (not included).



One large and four smaller clear plastic base grids are included with this kit to help keep the circuit blocks properly spaced. You will see evenly spaced posts that the different blocks snap into. The large base has rows labeled AG and columns labeled 1-10, and the small base has rows labeled A-E and columns labeled 1-7. It should be obvious whether to use a small base grid or a large base grid. For small circuits that only need one grid, either size may be used.

Next to each part in every circuit drawing is a small number in black. This tells you which level the component is placed at. Place all parts on level 1 first, then all of the parts on level 2, then all of the parts on level 3, etc.

Some circuits use the jumper wires to make unusual connections. Just clip them to the metal snaps or as indicated.



When assembling the 3D circuits, the order in which parts are installed is important. In particular, the vertical snap wires (V1) need to be snapped onto the mini base grid first and then the mini base grid is slid into the base grid support as shown below.

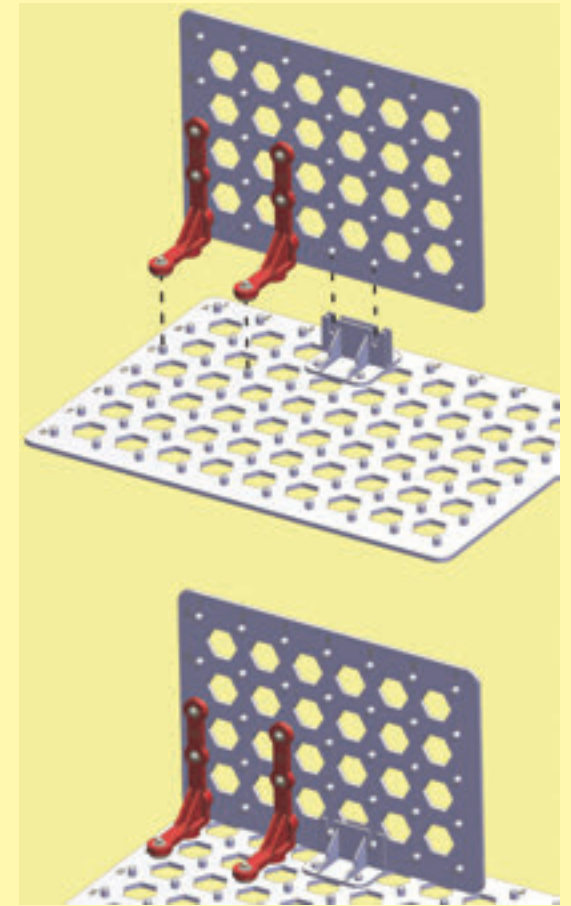

How to Use Boffin

Due to the complex nature of building 3D circuits, the circuit diagrams use special symbols that may need additional clarification. One such example is the symbol for the vertical snap wire (V1). It consists of two parts, the horizontal base and vertical stem. In the illustration below, the base is attached to the large base grid and the stem is attached to the mini base grid. The symbol makes V1 appear as two separate parts, but in reality the symbol is connected at the red circular ends.

Another symbol of note is the base grid support. It is important to pay attention to the orientation of the part in the diagram since it is not symmetrical. The figure below shows the symbol with the narrow channel on top. This corresponds to the 3D rendering showing the base grid support orientation.

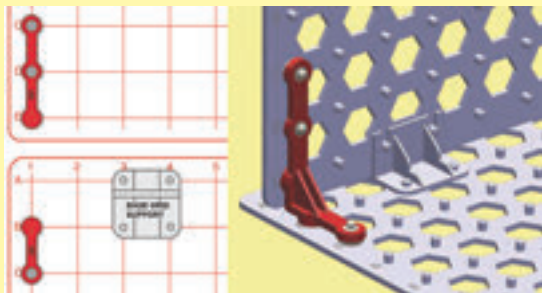

When inserting the base grid into the base grid support, it is a good idea to insert an area on the base grid that doesn't have raised letters or numbers. The raised text can interfere with the insertion or cause a tight fit between the base grid and base grid support.



To install the base grid support onto the base grid, align the holes of the support with the base grid pegs in the desired location on the base grid and press down firmly on the base grid support. Make sure that the base grid support is fully seated on the base grid.

The stabilizer is used to connect base grids on their corners or edges. With eight slots, the stabilizer allows the base grids to be mounted in increments of 45 degrees. To attach the stabilizer to the base grid, simply align the desired grooves in the stabilizer with the edges of the base grids and press down. The figure below shows how the stabilizer symbol is presented in the manual and the 3D rendering of the stabilizer mounted to two base grids.

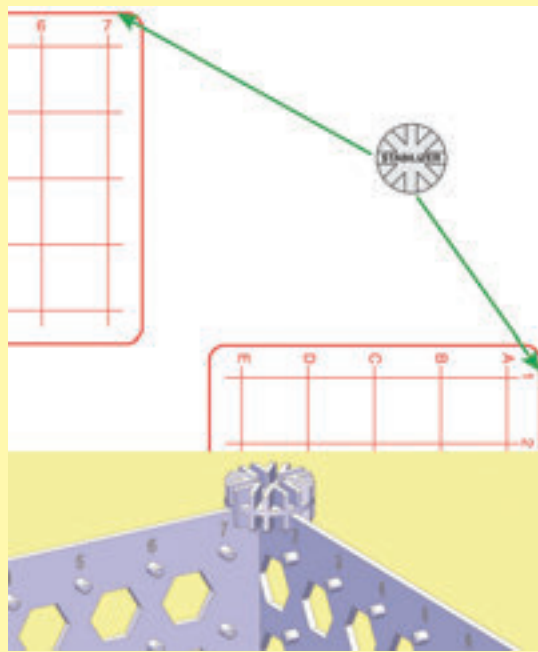

Note: Go to: www.boffin.cz for interactive 3D pictures to help with building the 3D circuits.

The mirror assembly consists of three parts: the mirror, the mirror mounting base, and the spring (sometimes the spring is not used). Begin by connecting the spring to the mirror mounting base. To achieve this, you need to line up the large end of the spring with the post on the bottom of the mounting base. Then, with the mounting base in one hand and the spring in the other, push the two pieces together while turning the mounting base counter-clockwise and the spring clockwise until it is fully seated (see figure below).

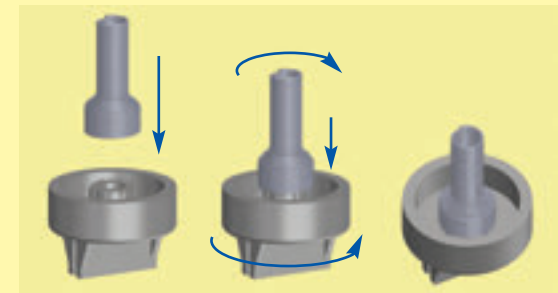

When the time comes to remove the spring, simply twist the spring clockwise while pulling it away from the mounting base.

Next, remove the protective backing off both sides of the mirror and align it with the groove on top of the mirror mounting base. Press the two parts together until the mirror is fully seated and centered on the mounting base.

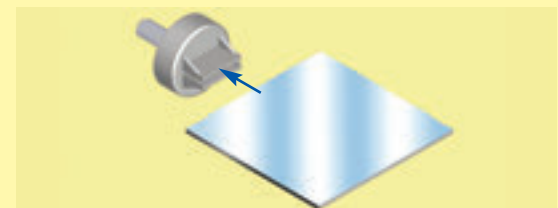

Note: While building the projects, be careful not to accidentally make a direct connection across the battery holder (a "short circuit"), as this may damage and/or quickly drain the batteries.

About Your Boffin Parts

(Part designs are subject to change without notice).

BASE GRID

The **base grids** are platforms for mounting parts and wires. They function like the printed circuit boards used in most electronic products, or like how the walls are used for mounting the electrical wiring in your home. This set has two sizes, which can be placed together to form larger grids.



SLIDE & PRESS SWITCHES

The **slide & press switches (S1 & S2)** connect (pressed or "ON") or disconnect (not pressed or "OFF") the wires in a circuit. When ON they have no effect on circuit performance. Switches turn on electricity just like a faucet turns on water from a pipe.

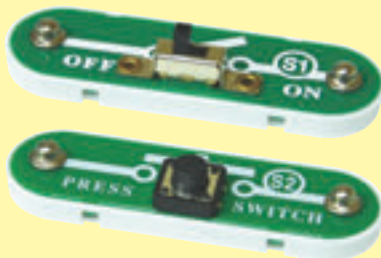

Slide & Press Switches (S1 & S2)

SNAP WIRES, VERTICAL SNAP WIRES, & JUMPER WIRES

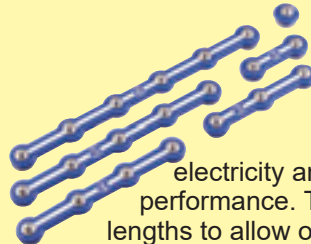

The blue **snap wires** are wires used to connect components. They are used to transport electricity and do not affect circuit performance. They come in different lengths to allow orderly arrangement of connections on the base grid.



The **vertical snap wires (V1)** make connections between two dimensions, allowing electricity to go up a wall.

The **jumper wires** (red, black, & blue) make flexible connections for times when using the snap wires would be difficult. They also are used to make connections off the base grid.

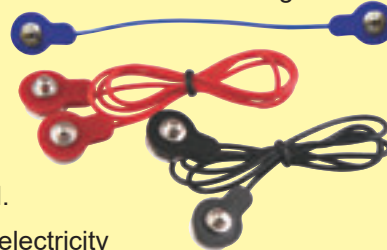

Wires transport electricity just like pipes are used to transport water. The colorful plastic coating protects them and prevents electricity from getting in or out.

BATTERY HOLDER

The **batteries (B3)** produce an electrical voltage using a chemical reaction. This "voltage" can be thought of as electrical pressure, pushing electricity through a circuit just like a pump pushes water through pipes. This voltage is much lower and much safer than that used in your house wiring. Using more batteries increases the "pressure", therefore, more electricity flows.

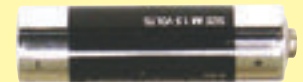

Battery Holder (B3)

HORN

The **horn (W1)** converts electricity into sound by making mechanical vibrations. These vibrations create variations in air pressure, which travel across the room. You "hear" sound when your ears feel these air pressure variations.

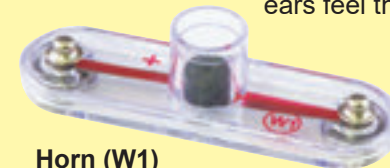

Horn (W1)

About Your Boffin Parts

RESISTORS

Resistors “resist” the flow of electricity and are used to control or limit the current in a circuit. This set includes a **5.1kΩ resistor (R3)** (“k” symbolizes 1,000, so R3 is really 5,100W). Materials like metal have very low resistance (<1W), while materials like paper, plastic, and air have near-infinite resistance. Increasing circuit resistance reduces the flow of electricity.



5.1kΩ Resistor (R3)

LEDs

The **white and color LEDs (D6 & D8)** are light emitting diodes, and may be thought of as a special one-way light bulbs. In the “forward” direction, (indicated by the “arrow” in the symbol) electricity flows if the voltage exceeds a turn-on threshold brightness then increases. The color LED contains red, green, and blue LEDs, with a micro-circuit controlling them. A high current will burn out an LED, so the current must be limited by other components in the circuit (Boffin LEDs have internal resistors added, to protect them in case you make wiring mistakes). LEDs block electricity in the “reverse” direction.

LEDs
(D6 & D8)



TRANSISTORS

The **NPN transistor (Q2)** is a component that uses a small electric current to control a large current, and are used in switching, amplifier, and buffering applications. Transistors are easy to miniaturize, and are the main building blocks of integrated circuits including the microprocessor and memory circuits in computers.



NPN Transistor (Q2)

The **phototransistor (Q4)** is a transistor that uses light to control electric current.



Phototransistor (Q4)

LIGHT TUNNEL

The **light tunnel (U30)** contains 3 red, 3 green, and 3 blue LEDs, arrayed with mirroring effects.

- When voltage is applied across the (+) and R (or RED) snaps, the red LEDs light.
- When voltage is applied across the (+) and G (or GRN) snaps, the green LEDs light.
- When voltage is applied across the (+) and B (or BLU) snaps, the blue LEDs light.
- When voltage is applied across the (+) and (-) snaps, circuitry in it lights the LEDs in a changing pattern.



Light Tunnel (U30)

Introduction to Electricity

What is electricity? Nobody really knows. We only know how to produce it, understand its properties, and how to control it. Electricity is the movement of subatomic charged particles (called **electrons**) through a material due to electrical pressure across the material, such as from a battery.

Power sources, such as batteries, push electricity through a circuit, like a pump pushes water through pipes. Wires carry electricity, like pipes carry water. Devices like LEDs, motors, and speakers use the energy in electricity to do things. Switches and transistors control the flow of electricity like valves and faucets control water. Resistors limit the flow of electricity.

The electrical pressure exerted by a battery or other power source is called **voltage** and is measured in volts (V). Notice the “+” and “-” signs on the battery; these indicate which direction the battery will “pump” the electricity.

The **electric current** is a measure of how fast electricity is flowing in a wire, just as the water current describes how fast water is flowing in a pipe. It is expressed in **amperes** (A) or **milliamps** (mA, 1/1000 of an ampere).

The “**power**” of electricity is a measure of how fast energy is moving through a wire. It is a combination of the voltage and current (Power = Voltage x Current). It is expressed in **watts** (W).

The **resistance** of a component or circuit represents how much it resists the electrical pressure (voltage) and limits the flow of electric current. The relationship is Voltage = Current x Resistance. When the resistance increases, less current flows. Resistance is measured in **ohms** (W), or **kilo ohms** (kW, 1000 ohms).

Nearly all of the electricity used in our world is produced at enormous generators driven by steam or water pressure. Wires are used to efficiently transport this energy to homes and businesses where it is used. Motors convert the electricity back into mechanical form to drive machinery and appliances. The most important aspect of electricity in our society is that it allows energy to be easily transported over distances.

Note that “distances” includes not just large distances but also tiny distances. Try to imagine a plumbing structure of the same complexity as the circuitry inside a portable radio - it would have to be large because we can't make water pipes so small. Electricity allows complex designs to be made very small.

There are two ways of arranging parts in a circuit, in series or in parallel. Here are examples:

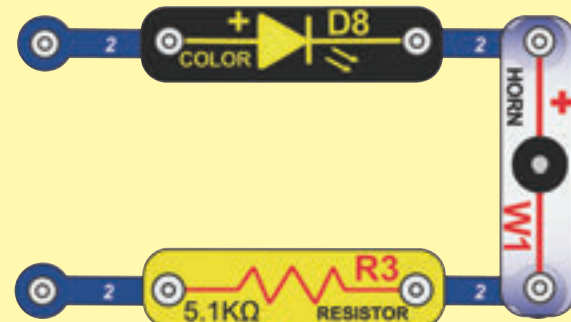

Series Circuit

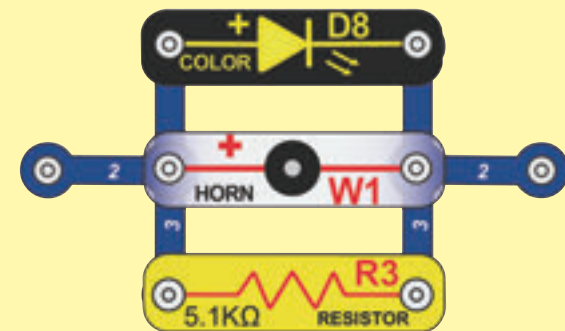

Parallel Circuit

Placing components in series increases the resistance; highest value dominates. Placing components in parallel decreases the resistance; lowest value dominates.

The parts within these series and parallel sub-circuits may be arranged in different ways without changing what the circuit does. Large circuits are made of combinations of smaller series and parallel circuits.

DOs and DON'Ts of Building Circuits

After building the circuits given in this booklet, you may wish to experiment on your own. Use the projects in this booklet as a guide, as many important design concepts are introduced throughout them. Every circuit will include a power source (the batteries), a resistance (which might be a resistor, horn, LED (which has an internal protection resistor), light tunnel, etc.), and wiring paths between them and back. **You must be careful not to create "short circuits" (very low resistance paths across the batteries, see examples below) as this will damage components and/or quickly drain your batteries.** Only connect the light tunnel (U30) using configurations given in the projects, incorrectly doing so may damage it. **ConQuest entertainment is not responsible for parts damaged due to incorrect wiring.**

Here are some important guidelines:

ALWAYS USE EYE PROTECTION WHEN EXPERIMENTING ON YOUR OWN.

ALWAYS include at least one component that will limit the current through a circuit, such as a resistor, horn, an LED (which has an internal protection resistor), light tunnel (which must be connected properly).

ALWAYS use switches in conjunction with other components that will limit the current through them. Failure to do so will create a short circuit and/or damage those parts.

ALWAYS disconnect your batteries immediately and check your wiring if something appears to be getting hot.

ALWAYS check your wiring before turning on a circuit.

ALWAYS connect the light tunnel (U30) using configurations given in the projects or as per the connection descriptions for the parts.

NEVER connect to an electrical outlet in your home in any way.

NEVER leave a circuit unattended when it is turned on.

For all of the projects given in this book, the parts may be arranged in different ways without changing the circuit. For example, the order of parts connected in series or in parallel does not matter — what matters is how combinations of these sub-circuits are arranged together.

3D Construction: Motors or other parts that produce motion (which you may have from other Boffin sets) should not be mounted overhead or on walls, as the vibrations they produce could cause them to fall.



Warning to Boffin owners: Do not connect the additional voltage sources from other sets, or you may damage your parts. Contact ConQuest entertainment if you have questions or need guidance.

Examples of SHORT CIRCUITS: NEVER DO THESE!!!

Placing a 3-snap wire directly across the batteries is a **SHORT CIRCUIT**.



NEVER DO

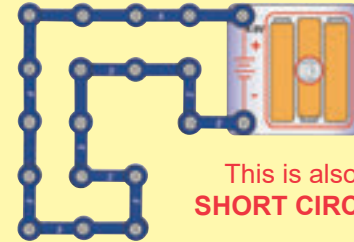
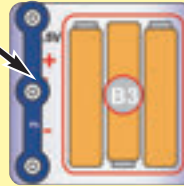

NEVER DO

This is also a **SHORT CIRCUIT**.

When the slide switch (S1) is turned on, this large circuit has a **SHORT CIRCUIT** path (as shown by the arrows). The short circuit prevents any other portions of the circuit from ever working.

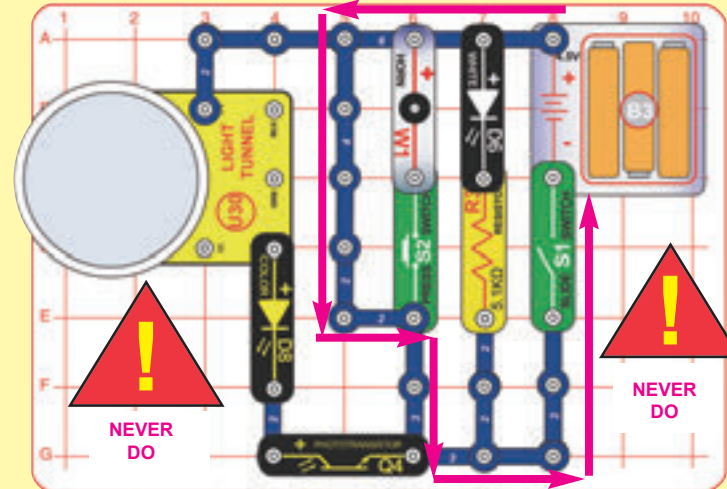

NEVER DO



NEVER DO

You are encouraged to tell us about new programs and circuits you create.

If they are unique, we will post them with your name and state on our website at: www.toy.cz. Send your suggestions to ConQuest entertainment: info@toy.cz.



WARNING: SHOCK HAZARD - Never connect Boffin to the electrical outlets in your home in any way!

Advanced Troubleshooting (Adult supervision recommended)

ConQuest entertainment is not responsible for parts damaged due to incorrect wiring.

If you suspect you have damaged parts, you can follow this procedure to systematically determine which ones need replacing:

1. **White LED (D6), color LED (D8), horn (W1), and battery holder (B3):** Place batteries in holder. Place the white LED, and color LED directly across the battery holder (LED + to battery +), the LED should light. Similarly, place the horn directly across the battery holder (+ to +), it should make sound. If none work, then replace your batteries and repeat, if still bad then the battery holder is damaged.

2. **Jumper wires:** Use this minicircuit to test each jumper wire, the LED should light.

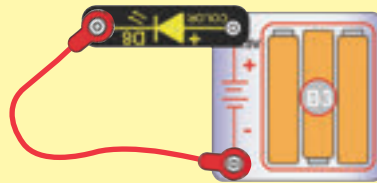

3. **Snap wires:** Use this minicircuit to test each of the snap wires, one at a time. The LED should light.

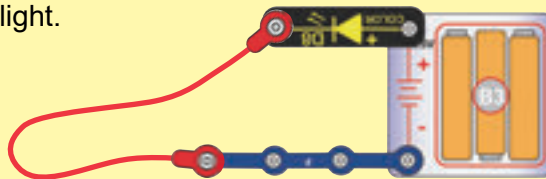

4. **Vertical snap wires (V1):** Use this mini-circuit to test each of the vertical snap wires, one at a time. The LED should light.

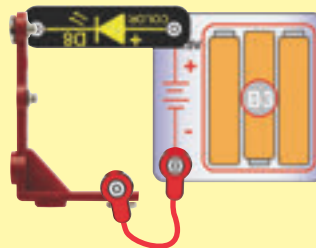

5. **Slide switch (S1) and press switch (S2):** Build project 1; if the color LED (D8) doesn't light then the slide switch is bad. Replace the slide switch with the press switch to test it.

6. **Phototransistor (Q4) and 5.1kW resistor (R3):** Build project 54 and vary the amount of light shining on the phototransistor. The brighter the light on the phototransistor, the brighter the color LED (D8) should be. Then replace the phototransistor with the 5.1kW resistor; the color LED should light dimly.

7. **NPN transistor (Q2):** Use project 98; the white LED (D6) should be on only if the press switch (S2) is pushed. If otherwise then Q2 is damaged.

8. **Light tunnel (U30):** Use project 136 to test it.

ConQuest entertainment a.s.
Kolbenova 961, Praha 9

Tel: 284 000 111

www.boffin.cz

www.toy.cz

You may order additional / replacement parts at:
www.toy.cz

Project Listings

Project	Description	Page	Project	Description	Page	Project	Description	Page
1.	Color Light	13	29.	Break the Beam	35	57.	Dim Red Light Tunnel	49
2.	White Light	13	30.	Block the Sound	36	58.	Dim Blue Light Tunnel	49
3.	Horn	13	31.	Light & Sound	37	59.	Bright Light Tunnel	49
4.	Simple Light Tunnel	14	32.	A New Light & Sound	37	60.	Blinking Blue Light Tunnel	50
5.	Fireworks	14	33.	Light Tunnel	37	61.	Blinking Red Light Tunnel	50
6.	White Light Display	14	34.	3D Color	38	62.	Blinking Green Light Tunnel	50
7.	Projector	15	35.	3D Color Mess	39	63.	Blinking Red & Blue Light Tunnel	50
8.	Ceiling Projector	15	36.	3D Color LEDs	39	64.	Blinking Green & Blue Light Tunnel	50
9.	Color Projector	15	37.	Your 3D Color	39	65.	Blinking Red & Green Light Tunnel	50
10.	Tri-Color Light Tunnel	16	38.	3D Color Splat	40	66.	Front & Back Circuit	51
11.	Red Light Tunnel	16	39.	3D Color Fun	40	67.	Another Front & Back Circuit	51
12.	Green Light Tunnel	16	40.	3D Color Tech	41	68.	Break the Reflection Beam	52
13.	Blue Light Tunnel	16	41.	3D Color T-Rex	42	69.	Bouncy Reflection Beam	52
14.	Red & Green Light Tunnel	16	42.	Automatic Light	42	70.	Break the 2-Reflection Beam	53
15.	Red & Blue Light Tunnel	16	43.	Elevated Automatic Light	43	71.	Bouncy Blur	54
16.	Green & Blue Light Tunnel	16	44.	Automatic Lights	44	72.	Light-Controlled Light Tunnel	54
17.	3D Illumination	17	45.	Super Automatic Lights	45	73.	2-Front Circuit	55
18.	3Di Fun	19	46.	Vertical Light Tunnel	45	74.	Another 2-Front Circuit	55
19.	Overhead Light	21	47.	Vertical Tri-Color Light Tunnel	46	75.	Series of LEDs	56
20.	Overhead Lights	22	48.	Vertical Dual-Color Light Tunnel	46	76.	Horn & Color Light	56
21.	Security House	23	49.	Vertical Single-Color Light Tunnel	46	77.	Horn & White Light	56
22.	Security House w/ 2 Outer Lights	25	50.	Wall Light Show	47	78.	Parallel LEDs	56
23.	One-Mirror Circuit	27	51.	Wall Projector	47	79.	Horn & Color Light (II)	56
24.	One-Mirror Blinking Circuit	29	52.	Dim Color Light	48	80.	Horn & White Light (II)	56
25.	3-Wall House	31	53.	Dim White Light	48	81.	Triple Series?	57
26.	Two-Mirror Circuit	32	54.	Light-Controlled Light	48	82.	Triple Parallel	57
27.	Simple Two Mirror Circuit	32	55.	Light-Controlled White Light	48	83.	Four Fun	58
28.	Angled Roof House	33	56.	Dim Green Light Tunnel	49	84.	4 - 1 = 3 Fun	58

Project Listings

Project	Description	Page	Project	Description	Page	Project	Description	Page
85.	Four Fun Red	58	113.	IR Control	64	141.	Box Circuit	73
86.	Four Fun Green	58	114.	Color IR Control	64	142.	Burglar Alarm Box	74
87.	Four Fun Blue	58	115.	Audio IR Control	64	143.	Outer Lights House	75
88.	Four Fun Red & Green	58	116.	Photo Control Four	65	144.	Light Tunnel Tower	76
89.	Four Fun Red & Blue	58	117.	Light Up the Night	65	145.	Morse Code	77
90.	Four Fun Green & Blue	58	118.	Infrared Control Four	65	146.	Tower of Lights	77
91.	Vertical Four Fun	58	119.	Double Blinker	66	147.	Light-Controlled Light Tunnel	78
92.	Lights & Mirrors	59	120.	Green Double Blinker	66	148.	IR-Controlled Light Tunnel	78
93.	Noisy Lights & Mirrors	60	121.	Blue Double Blinker	66	149.	Liquid Conductor	79
94.	Lights & Blinkless Mirrors	60	122.	Multi Double Blinker	66	150.	Human Conductor	79
95.	Red Lights & Mirrors	60	123.	White Double Blinker	66	151.	Water Completes the Circuit	79
96.	Green Lights & Mirrors	60	124.	Alternating Lights	67	152.	You Complete the Circuit	79
97.	Blue Lights & Mirrors	60	125.	Loud Multi-Color Sound	67	153.	Mirrors on a Wall	80
98.	Transistor Control	60	126.	Loud Multi-Multi-Color Sound	67	154.	Color Light Box	81
99.	Transistor Amplifier	61	127.	Blue Blinking Fun	68	155.	Color Light Box Lens	81
100.	Another Transistor Amplifier	61	128.	Green Blinking Fun	68	156.	Projector Box	82
101.	Transistor Amplifier w/ Horn	61	129.	Red Blinking Fun	68	157.	Mini Overhead Light	83
102.	Alternating Lights Sound	61	130.	Red-Green Blinking Fun	68	158.	Mini Overhead Lights	83
103.	Photo Control	62	131.	Red-Blue Blinking Fun	68	159.	Floor-to-Ceiling Break the Beam	84
104.	Photo Control (II)	62	132.	Green-Blue Blinking Fun	68			
105.	Photo Control (III)	62	133.	Button Ball	69			
106.	Photo Control (IV)	62	134.	Hole Ball	69			
107.	High Sensitivity Photo Control	62	135.	Hole Ball with Light Tunnel	70			
108.	Reverse Photo Control	63	136.	Check the Light Tunnel	70			
109.	Reverse Photo Control (II)	63	137.	High Wind Alarm	71			
110.	Reverse Photo Control (III)	63	138.	Hit the 2-Snap	71			
111.	Infrared-Controlled Light	63	139.	Free Mirror Circuit	72			
112.	Infrared-Controlled Color Light	63	140.	Floor Mirror Circuit	72			



Project 1

Color Light

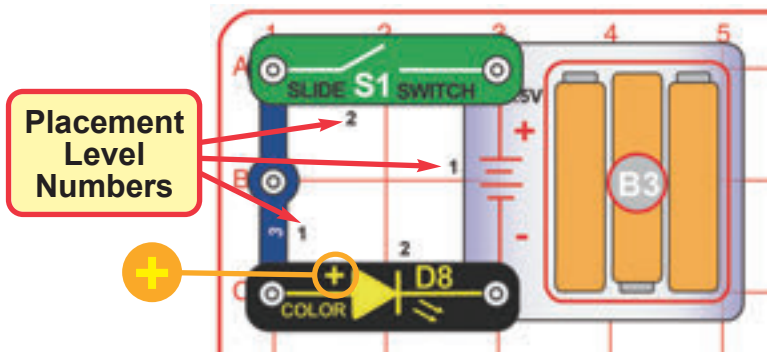

Boffin uses electronic blocks that snap onto a clear plastic base grid to build different circuits. These blocks have different colors and numbers on them so you can easily identify them. This set contains both large (11" x 7.7") and small (7.7" x 5.5") base grids; you may use either size for this small circuit.

Build the circuit shown on the left by placing all the parts with a black 1 next to them on the base grid first. Then, assemble parts marked with a 2. Install three (3) "AA" batteries (not included) into the battery holder (B3) if you have not done so already.

Turn on the slide switch (S1), and enjoy the light show from the color LED (D8). For best effects, dim the room lights.

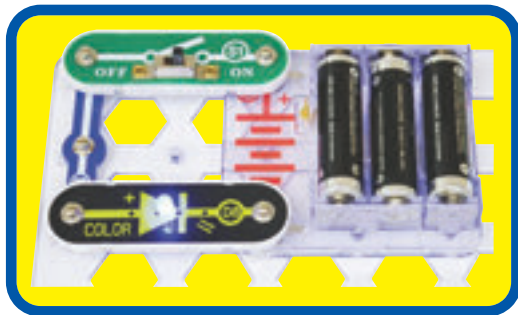

Snappy says when you turn on the slide switch, electricity flows from the batteries, through the color LED and back to the battery through the switch. If the switch is off, the flow of electricity is blocked, and the color LED won't light.

LEDs are light emitting diodes, which convert electrical energy into light. The color of the light depends on the characteristics of the material used in them. The color LED actually contains separate red, green, and blue lights, with a micro-circuit controlling them.



NOTE: this circuit (and many others in this book) have an LED being used without a resistor or other component to limit the electric current through it. Normally this could damage an LED but your Boffin LEDs include internal protection resistors, and will not be damaged. Be careful if you later use other electrical sets with unprotected LEDs.



Project 2 White Light



Project 3 Horn

Modify the preceding circuit by replacing the color LED (D8) with the white LED (D6), as shown. The white LED is brighter, but does not change colors.

The white LED produces very bright light. LEDs like this one are increasingly being used for home lighting and flashlights. They are more efficient than normal light bulbs.

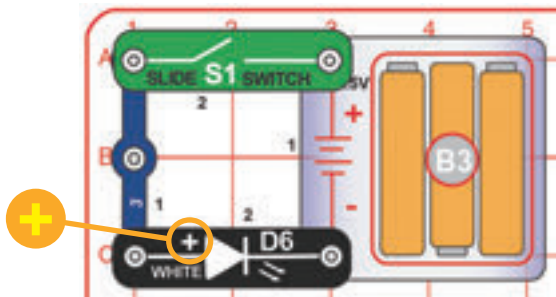

Modify the preceding circuit by replacing the white LED (D6) with the horn (W1), as shown. This circuit makes noise instead of light.

The horn converts electricity into sound by making mechanical vibrations. These vibrations create variations in air pressure which travel across the room. You "hear" when your ears feel these air pressure variations.

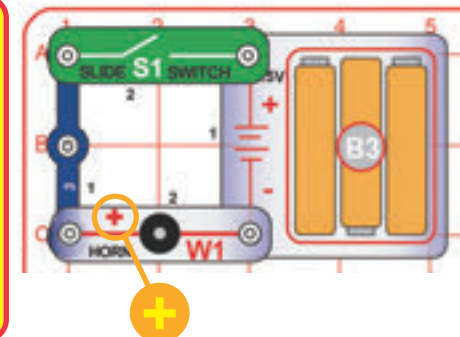



Project 4

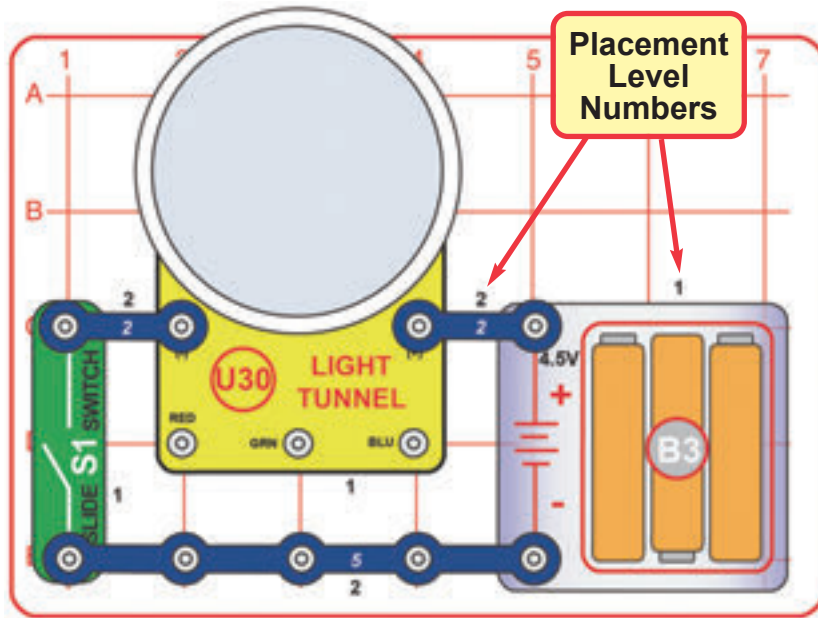

Simple Light Tunnel

Build the circuit shown on the left by placing all the parts with a black 1 next to them on the board first. Then, place parts marked with a 2. Install three (3) "AA" batteries (not included) into the battery holder (B3) if you have not done so already. Turn on the slide switch (S1). The light tunnel (U30) puts on a show. For best effects, dim the room lights. Try GENTLY pressing on the center of the mirror in the light tunnel, and notice how the light patterns bend inward a little.



The light tunnel has 3 red, 3 green, and 3 blue LEDs. There is a mirror behind them, and a semi-transparent mirror above them; the combination of these produces the effects you see.



Project 5

Fireworks

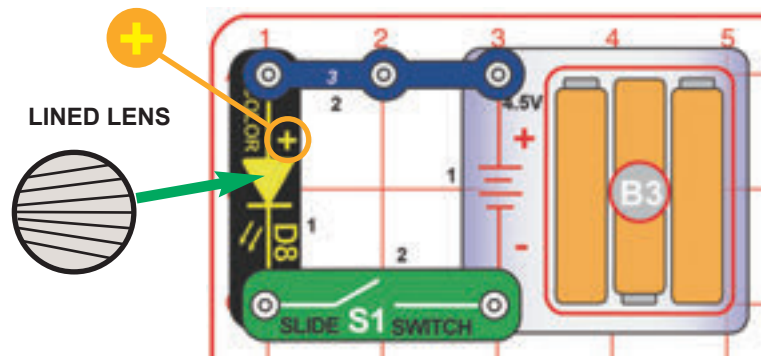

Place the lined lens attachment on the color LED (D8) and turn the clear part so that the lines on it converge towards the left, as shown. Turn on the slide switch (S1) and place the circuit so that the color LED is right next to a wall or box. The color LED and lined lens make a display of light that resembles a fireworks show. For best effects make the room very dark. Try rotating the lined lens and see how the light display changes.



Project 6 White Light Display

Use the preceding circuit but replace the color LED (D8) with the white LED (D6).



Project 7

These red pieces are the same vertical snap wire (V1), mounted so it stands up.

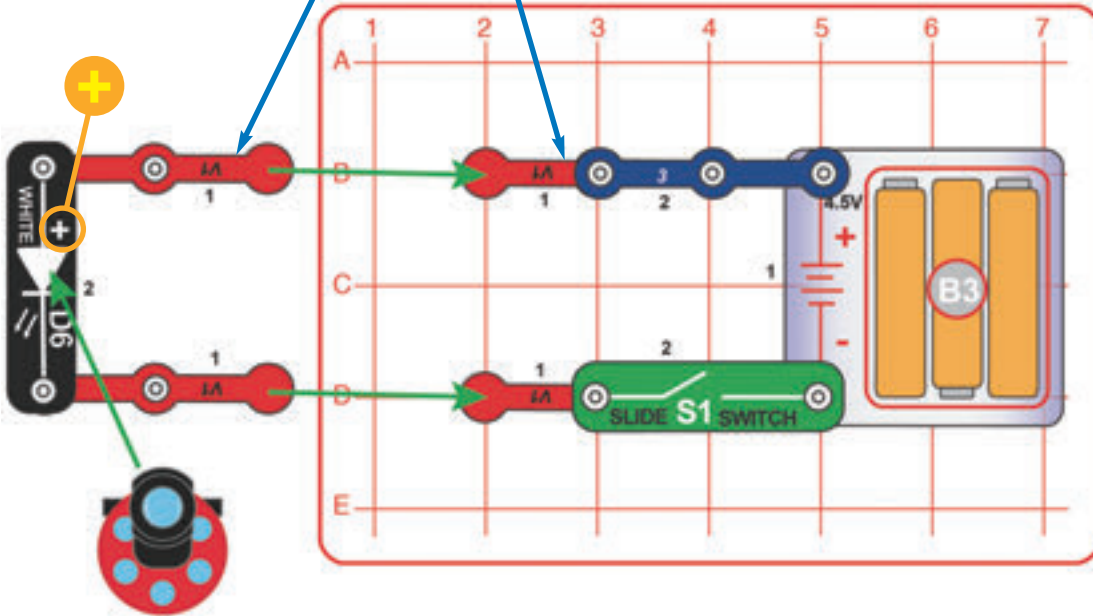

Projector

Use two vertical snap wires (V1) and mount the white LED (D6) on them so it will shine towards a wall, then place the projector on the white LED. Place the circuit in a dark room and point it towards a wall, white walls give best effects. Turn on the slide switch (S1) and adjust the knob on the projector to show the 6 images on the wall. The room should be very dark for best effects. You can also get good results by projecting the images on a white box a few feet away.



Project 8 Ceiling Projector

Use the project 2 circuit, but place the projector on the white LED (D6). Place the circuit in a dark room, preferably with a flat white ceiling. Turn on the slide switch (S1) and adjust the knob on the projector to show the 6 images on the ceiling. The room should be very dark for best effects.

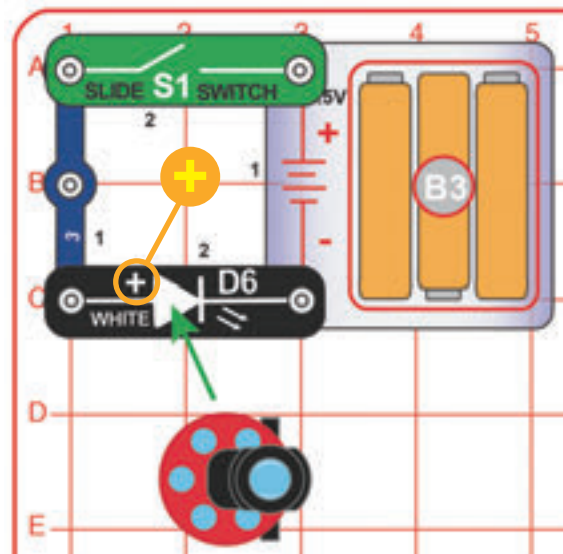

Project 9 Color Projector

Use either of the two preceding circuits but replace the white LED (D6) with the color LED (D8). The color LED is not as bright as the white LED, but the images look different for each color produced by the color LED. The effects are best seen in a very dark room.



Project 10

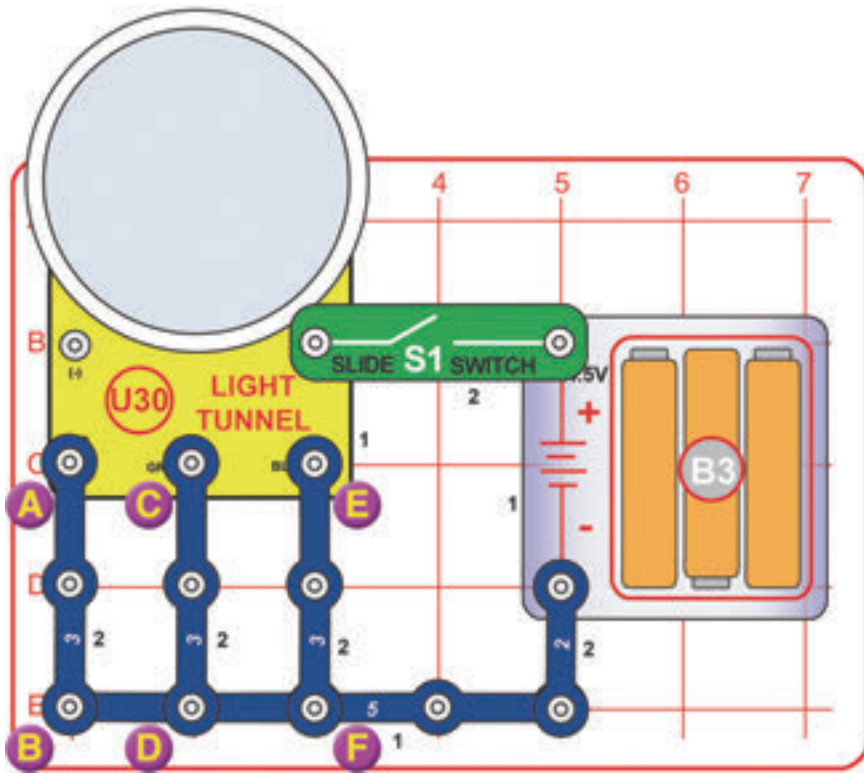

Tri-Color Light Tunnel

Turn on the slide switch (S1). The light tunnel (U30) lights up with red, green, and blue LEDs. For best effects, dim the room lights. Try GENTLY pressing on the center of the mirror in the light tunnel, and notice how the light patterns bend inward a little.



Project 11

Red Light Tunnel

Use the project 10 circuit, but remove the 3-snaps connected between the points marked C & D and E & F.



Project 12

Green Light Tunnel

Use the project 10 circuit, but remove the 3-snaps connected between the points marked A & B and E & F.



Project 13

Blue Light Tunnel

Use the project 10 circuit, but remove the 3-snaps connected between the points marked A & B and C & D.



Project 14

Red & Green Light Tunnel

Use the project 10 circuit, but remove the 3-snap connected between the points marked E & F.



Project 15

Red & Blue Light Tunnel

Use the project 10 circuit, but remove the 3-snap connected between the points marked C & D.



Project 16

Green & Blue Light Tunnel

Use the project 10 circuit, but remove the 3-snap connected between the points marked A & B.



Project 17

3D Illumination

This drawing looks complex, because it shows assembly of a 3-dimensional structure.



The grids fit into the supports easier if the column marking (1-7) is on this side.

These red pieces are the same vertical snap wire (V1), mounted so it stands up.

remove any protective backing

A

B

C

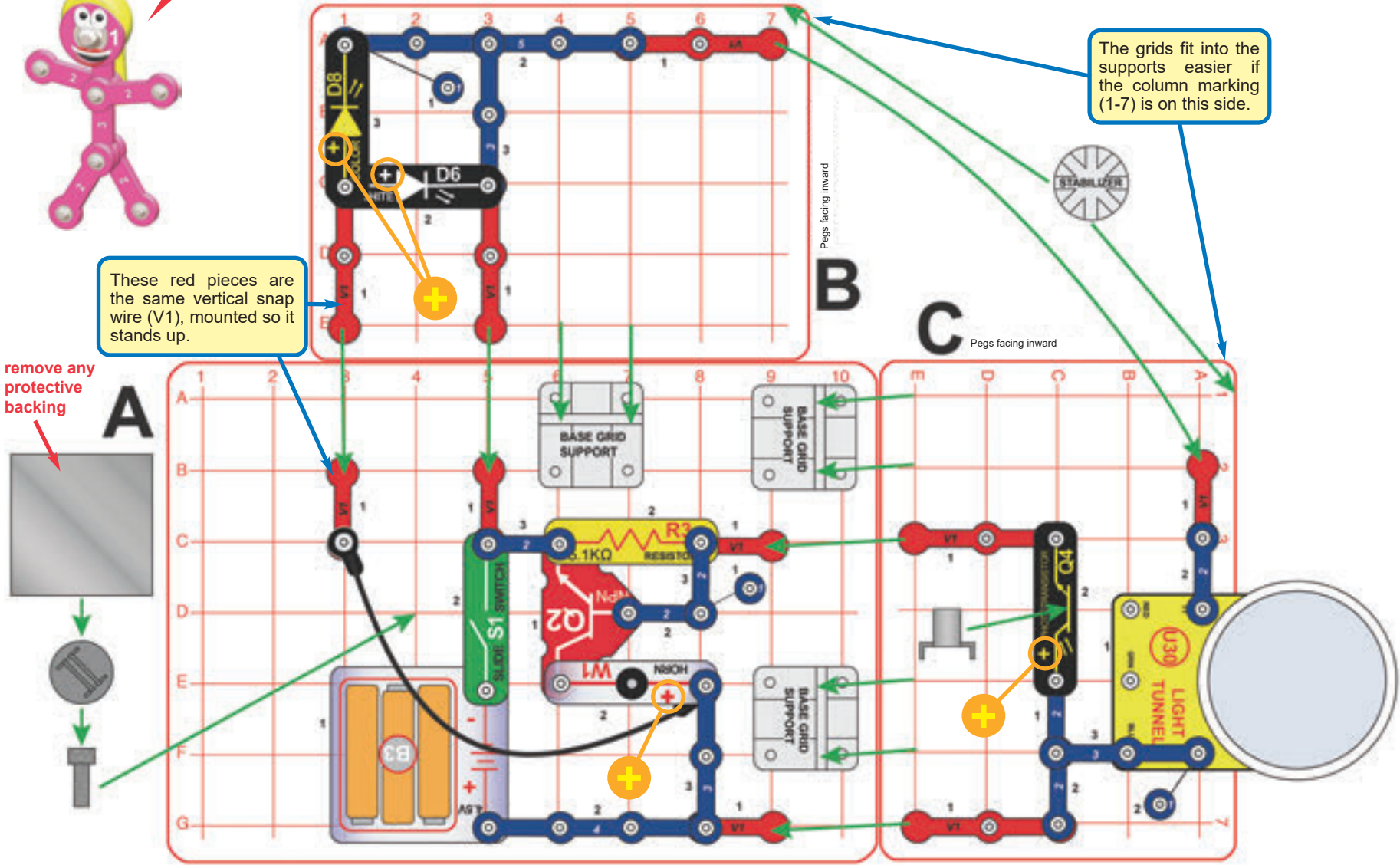

Assembly (adult supervision recommended). Follow these assembly instructions in order:

1. Place base grid supports on the base grid labeled A in the drawing.
2. Place parts on grid B, and install into base grid support on grid A.

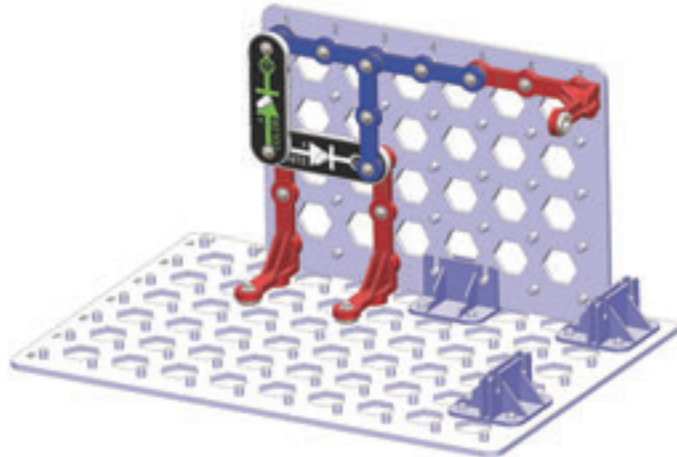

3. Place parts on grid C (except the vertical snap wire (V1) that connects to grid B, and the 2-snap wire that attaches to it), and install into base grid supports on grid A. Finish connection of the V1 connecting between grids B-C, add the 2-snap wire that attaches to it, and add the stabilizer between grids B & C.

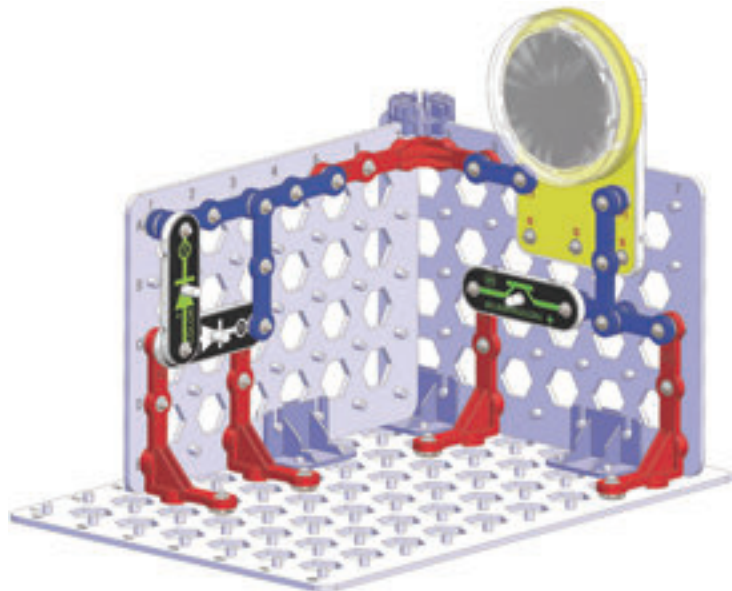

4. Install remaining parts on grid A.

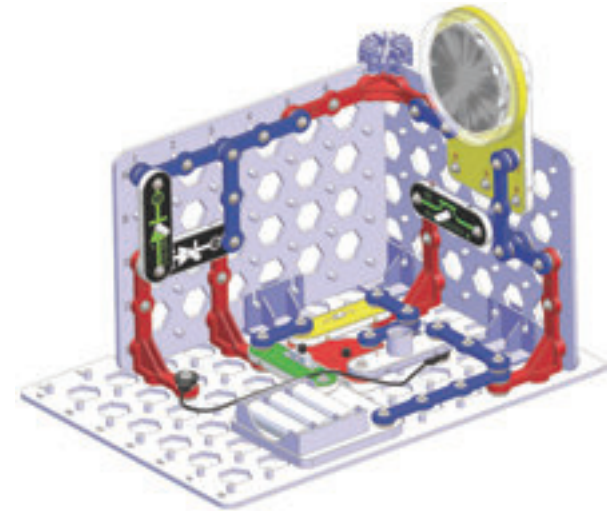

5. Add the mirror and Q4 attachment.

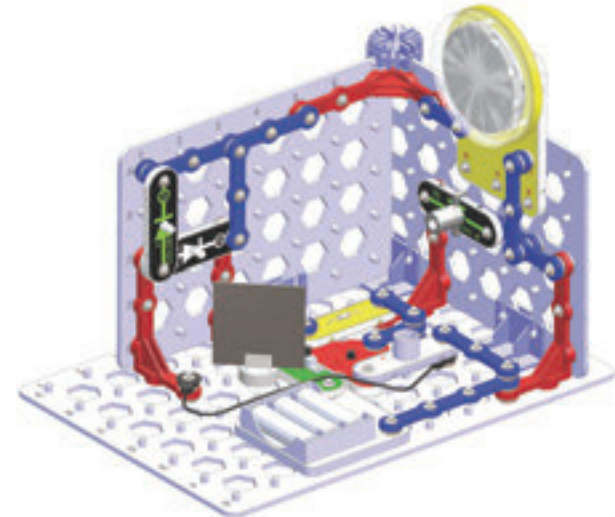

Turn on the slide switch (S1). The light tunnel (U30) and color LED (D8) put on a show. To trigger an alarm, align the mirror so light from the white LED (D6) reaches the phototransistor (Q4); remove and re-install it in the spring if needed. Try giving the mirror a push so it bounces back and forth on the spring. You can swap the locations of the white and color LEDs (D6 & D8), but in some cases the color LED may not activate the alarm. Go to www.boffin.cz for an interactive 3D picture to help with constructing this circuit.



Project 18

3Di Fun

This circuit is shown on the cover of the Boffin 3D Illumination box and manual. Use that picture to help with building it.



These red pieces are the same vertical snap wire (V1), mounted so it stands up.

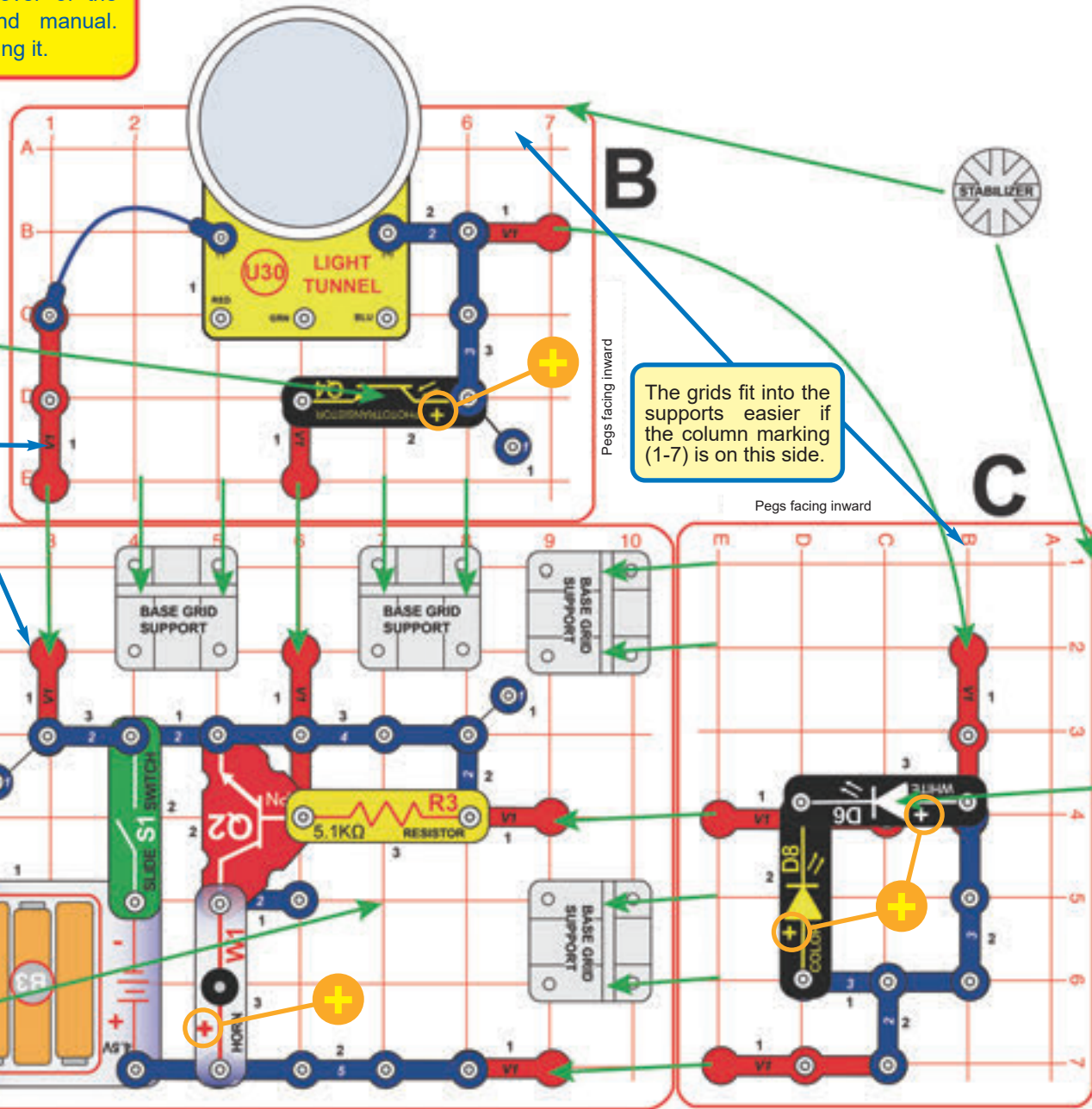

Pegs facing inward

The grids fit into the supports easier if the column marking (1-7) is on this side.

Pegs facing inward

Follow these assembly instructions, in order, using the photo on the box cover (and the cover of this booklet) as a guide:

1. Place base grid supports on the base grid labeled A in the drawing.
2. Place parts on grid C, and install into base grid support on grid A. Note that part of a vertical snap wire (V1) is under the white LED (D6).
3. Place parts on grid B (except the vertical snap wire that connects to grid C, and the 2-snap and 3-snap wires that attach to it), and install into base grid supports on grid A.

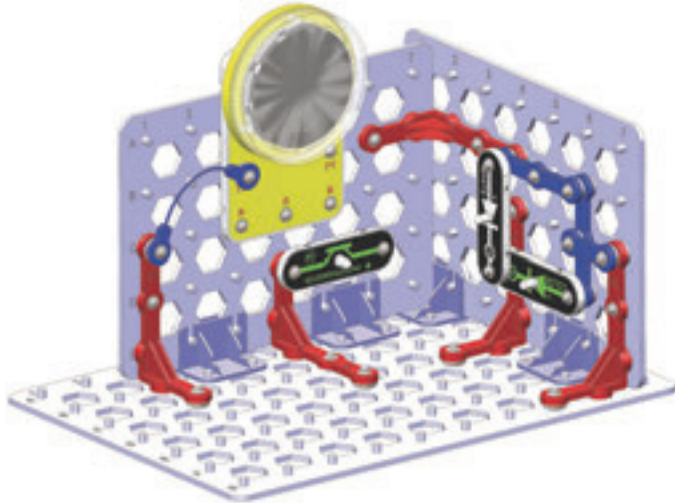

4. Finish connection of the V1 connecting between grids B-C, add the snap wires that attach to it, and add the stabilizer between grids B & C.

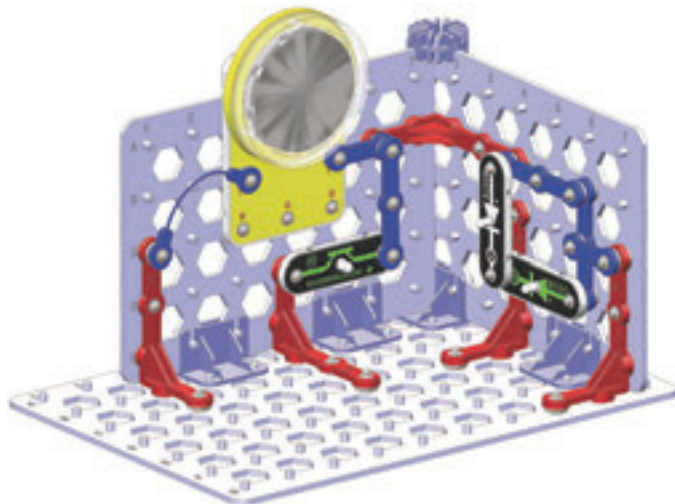

5. Install remaining parts on grid A.

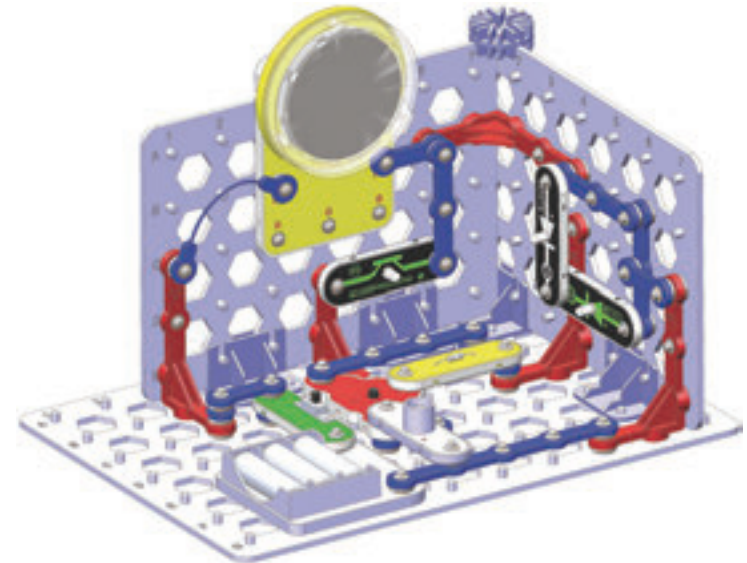

6. Add the projector, mirror, and Q4 attachment.

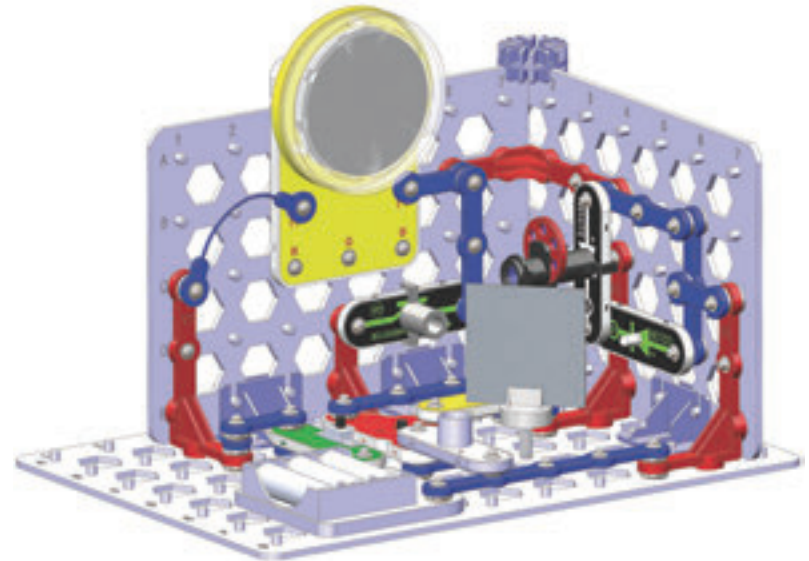

Turn on the slide switch (S1). The projector projects an image across the room (it is best viewed in a dark room), turn its knob to select different images. To trigger an alarm, align the mirror so light from the color LED (D8) reaches the phototransistor (Q4); remove and re-install it in the spring if needed. The images from the projector are rotated.



Project 19

Overhead Light



Think of this circuit as a room with an overhead light. LEDs are increasingly being used for room lighting.

Side view:

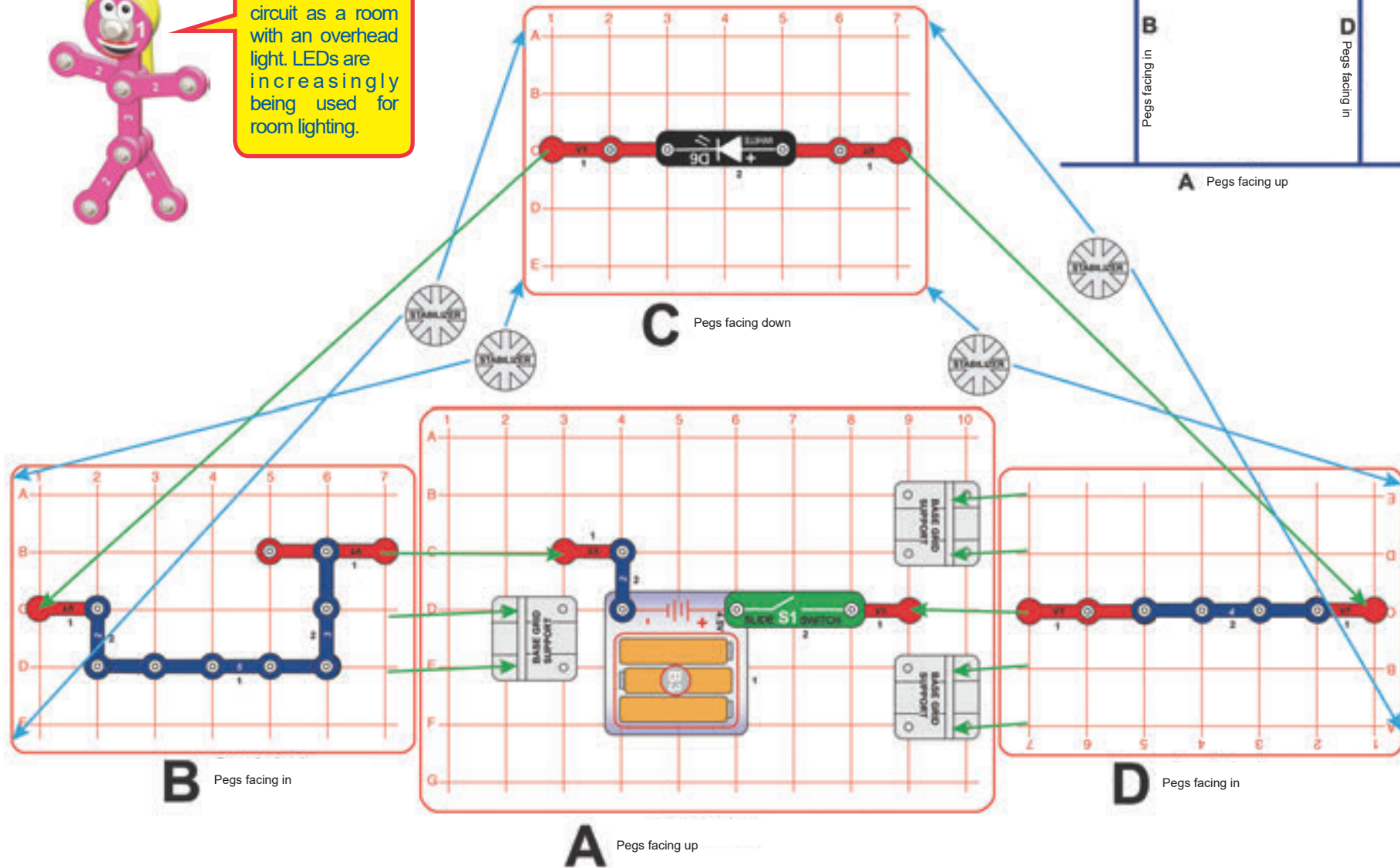
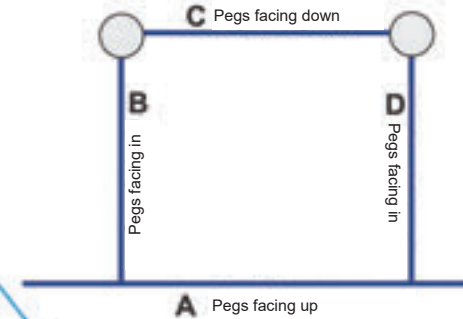

Assembly (adult supervision recommended):

1. Place base grid supports on base grid A.
2. Place parts on base grids B, & D, and install into base grid supports on grid A. The pegs should be facing inward.

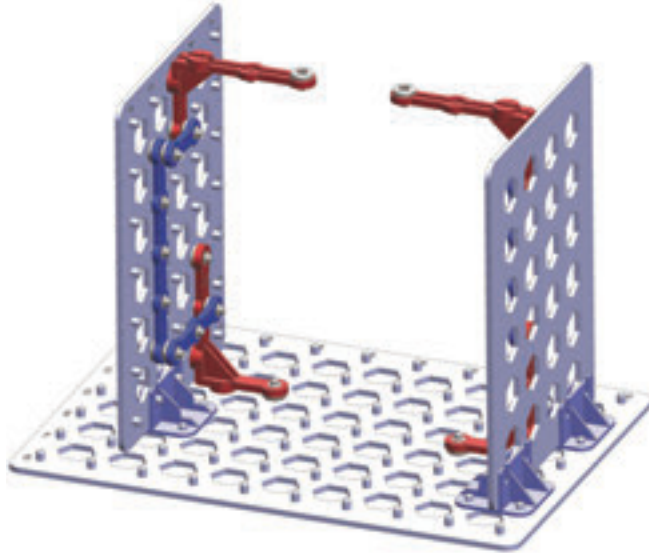

3. Mount grid C on top of grids B & D using 4 stabilizers, attaching the 2 vertical snap wires (V1) as you do it.

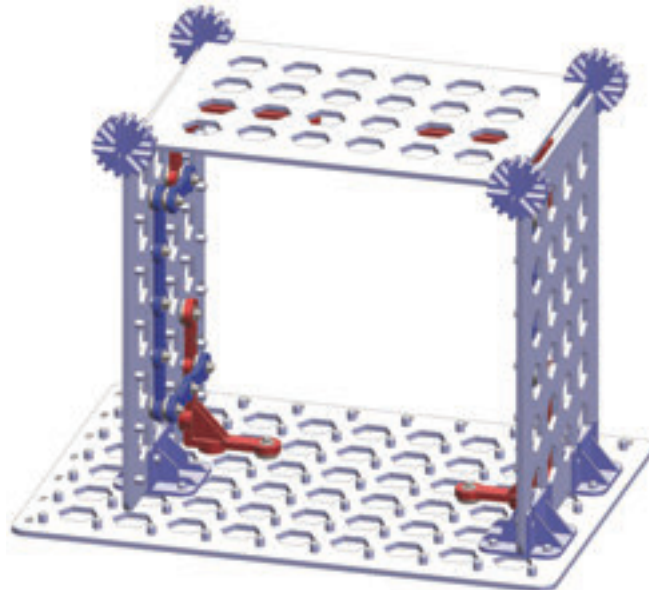

4. Place the remaining parts on grids A & C.

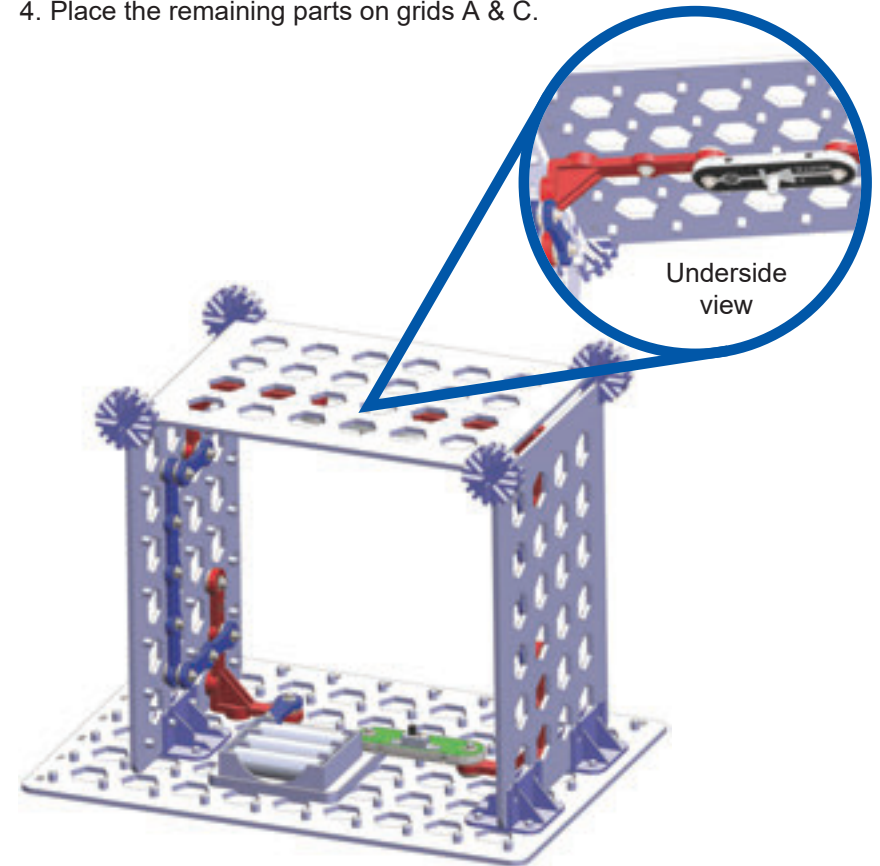

Turn on the slide switch (S1) to light the white LED (D6).



Project 20 Overhead Lights

Use the preceding circuit, but carefully replace the white LED (D6) with the color LED (D8), or carefully add the color LED next to the white LED as shown here.

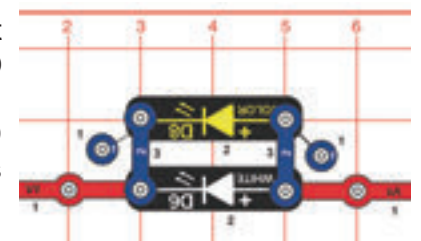



Project 21

Security House

Front-Side view:
Stabilizers are identified as F1-F3 and B1-B3 (Front 1-3 and Back 1-3), as shown on this drawing.

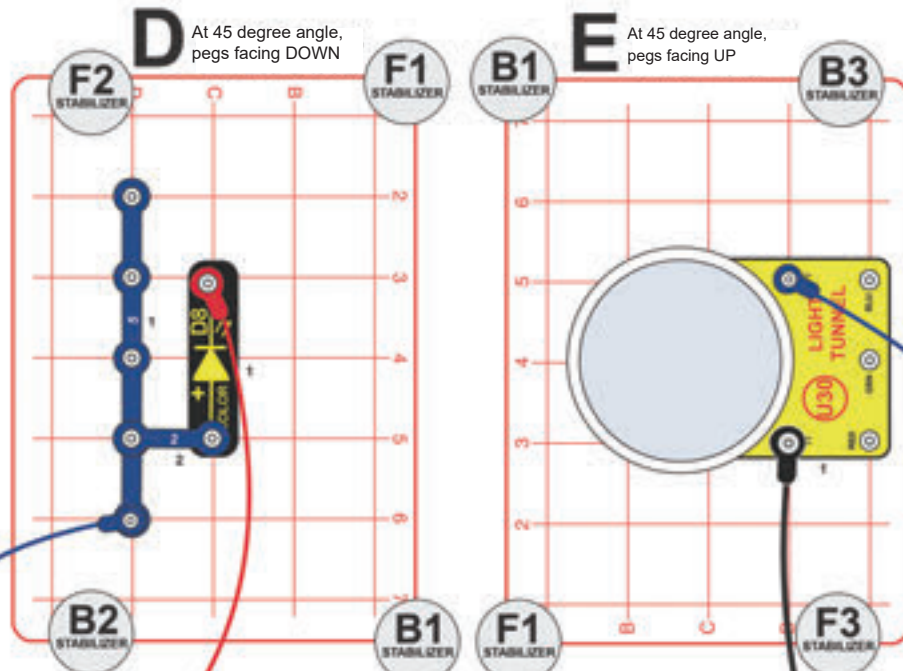
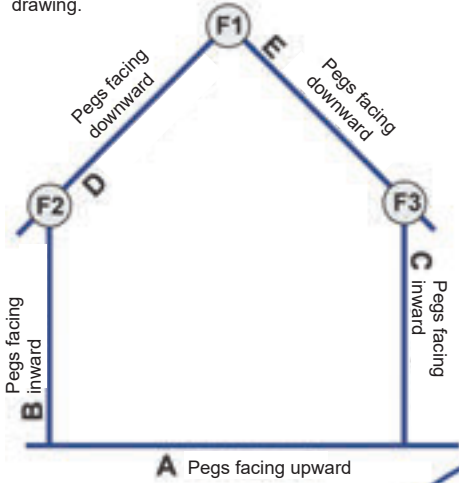

You can place an object inside this house, If an intruder tries to reach in and grab it, then the alarm sounds and color LED flashes to scare the intruder away.

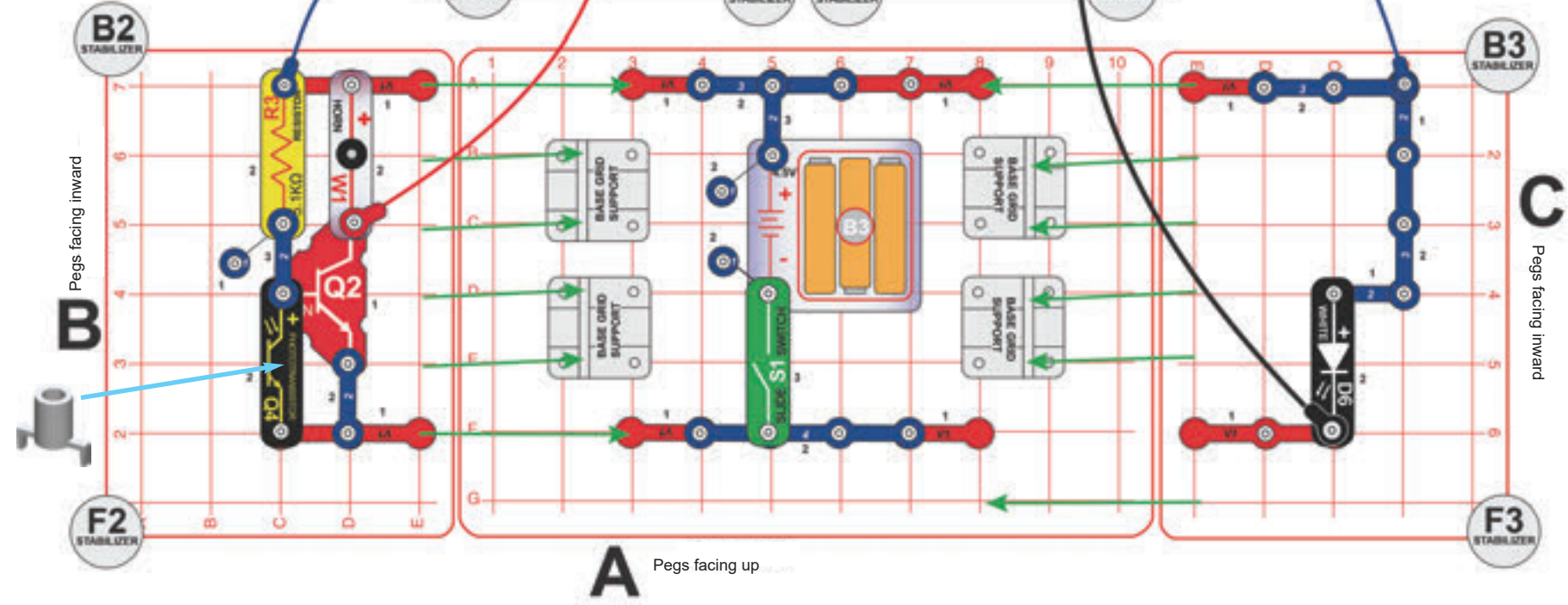

Assembly (adult supervision highly recommended):

1. Place base grid supports on base grid A.
2. Place parts (except for the jumper wires) on base grids B & C, and install into base grid supports on grid A. The pegs should be facing inward.

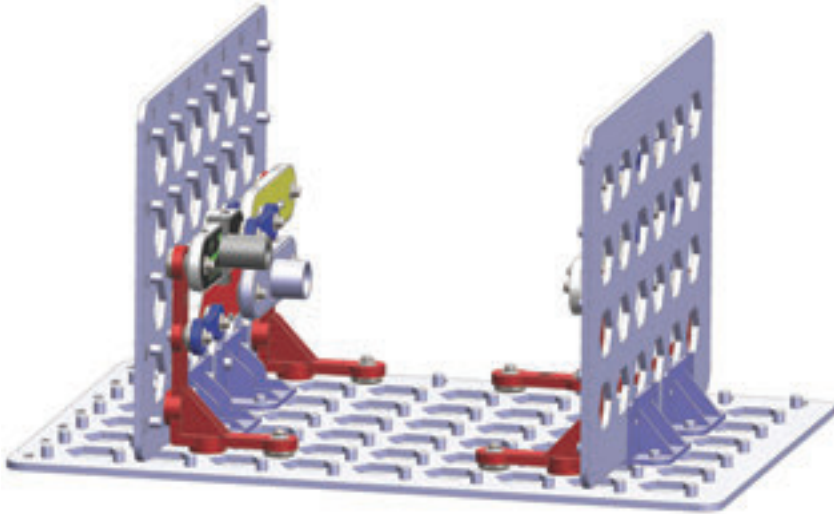

3. Place remaining parts on grid A.
4. Place parts (except jumper wires) on grid D.

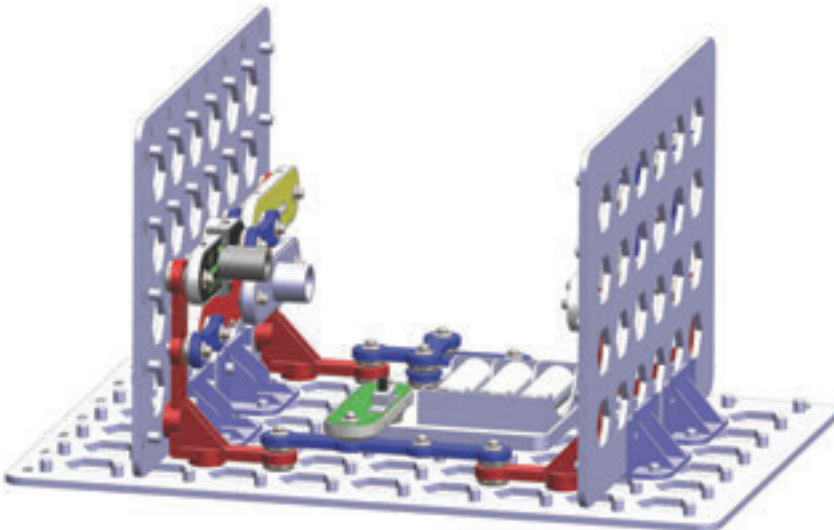

5. Mount grids D & E, at 45 degree angles and with pegs oriented as shown (down for grid D, up for grid E), on top of grids B & C using 6 stabilizers. Adjust the positions of the stabilizers as needed.

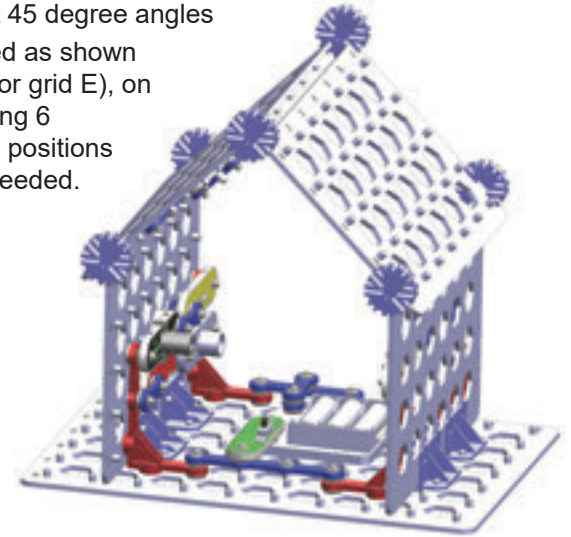

6. Gently place the light tunnel (U30) on grid E.
7. Add the Q4 attachment and jumper wires (2 blue, 1 red, and 1 black).

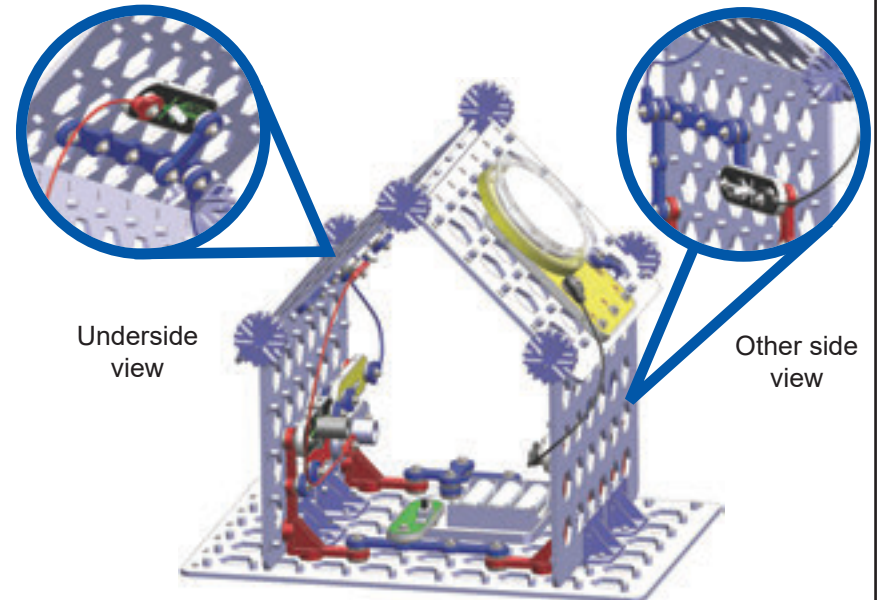

Turn on the slide switch (S1); the white LED (D6) and light tunnel should be on, but there should not be any sound. Now place your hand between the white LED and the phototransistor (Q4); an alarm sounds and the color LED (D8) turns on.



Project 22

Security House with 2 Outer Lights

Front-Side view:
Stabilizers are identified as F1-F3 and B1-B3
(Front 1-3 and Back 1-3), as shown on this drawing.

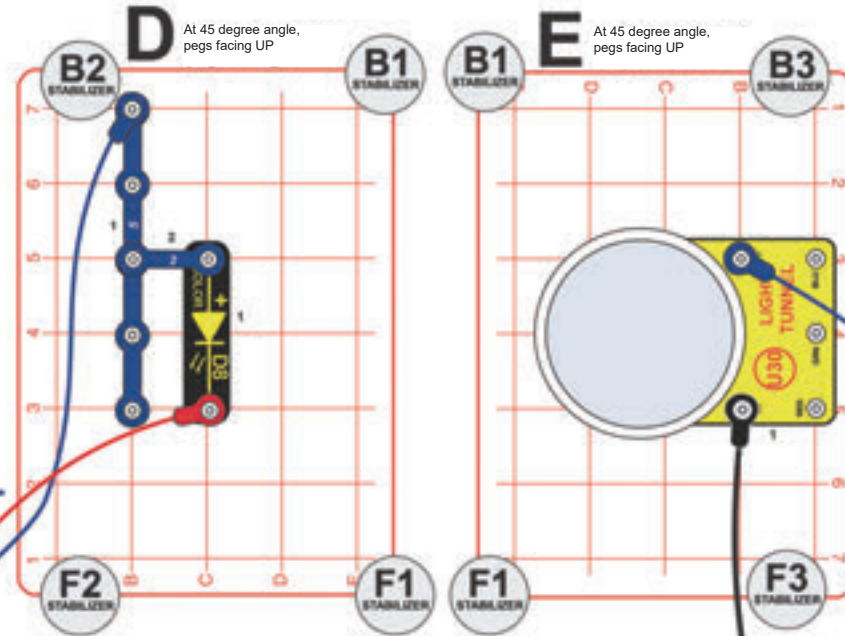
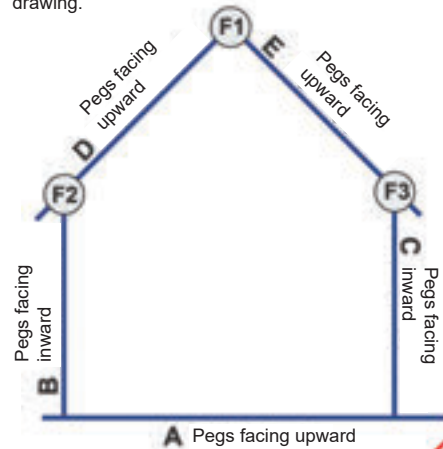

If desired, you can move the black the jumper wire from the (-) snap on the light tunnel to the R, G, or B snap on it.

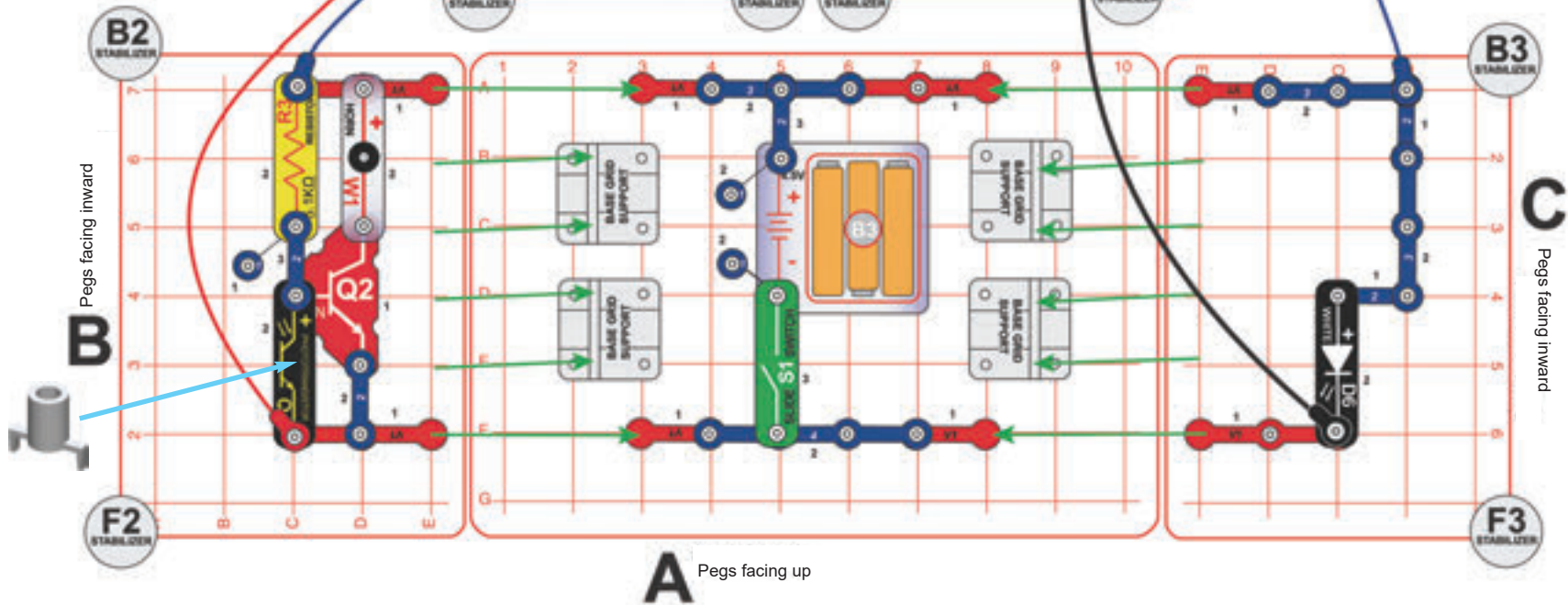

Modify the preceding circuit so the color LED (D8) shines up instead of down.

Assembly (adult supervision highly recommended):

1. Place base grid supports on base grid A.
2. Place parts (except for the jumper wires) on base grids B & C, and install into base grid supports on grid A. The pegs should be facing inward.

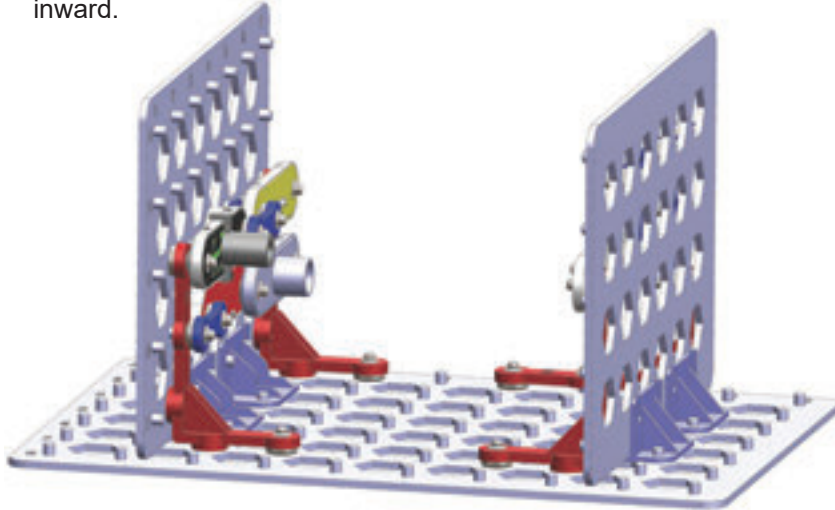

3. Place remaining parts on grid A.
4. Place parts (except jumper wires) on grid D.

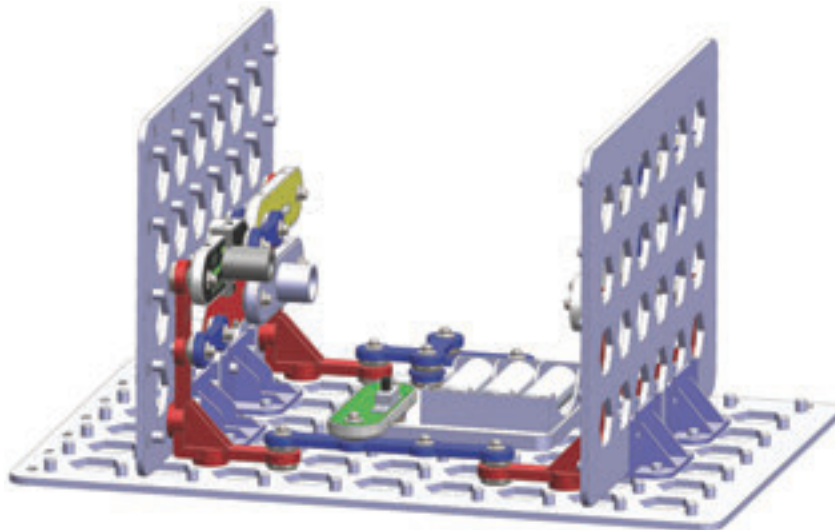

5. Mount grids D & E, at 45 degree angles and with pegs oriented as shown (down for grid D, up for grid E), on top of grids B & C using 6 stabilizers. Adjust the positions of the stabilizers as needed.

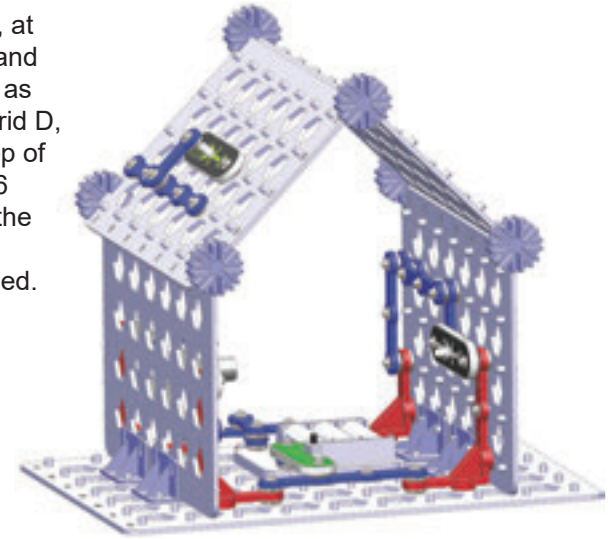

6. Gently place the light tunnel (U30) on grid E.
7. Add the Q4 attachment and jumper wires (2 blue, 1 red, and 1 black).

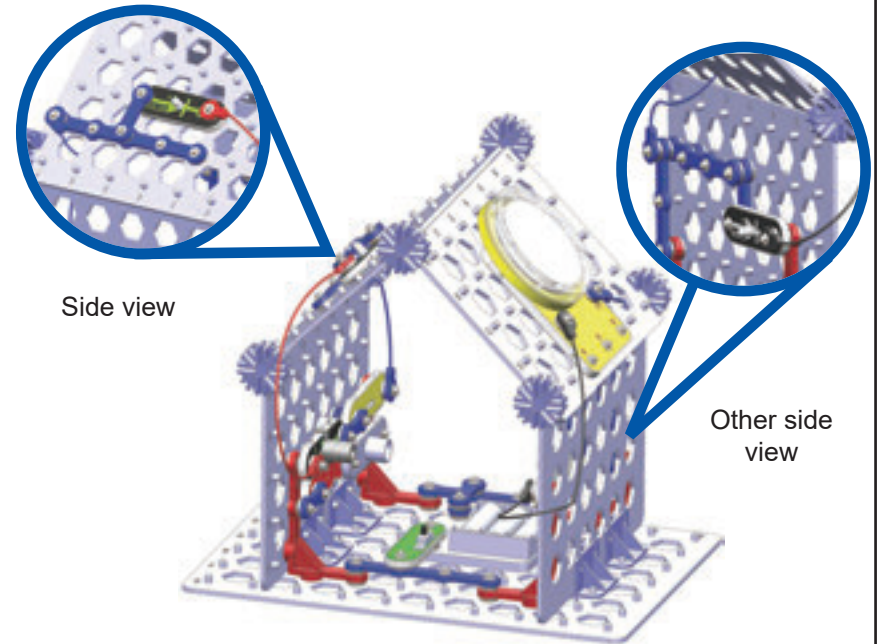

Turn on the slide switch (S1); the LEDs (D6 & D8) and light tunnel should be on, but there should not be any sound. Now place your hand between the white LED and the phototransistor (Q4); an alarm sounds.



Project 23

One-Mirror Circuit

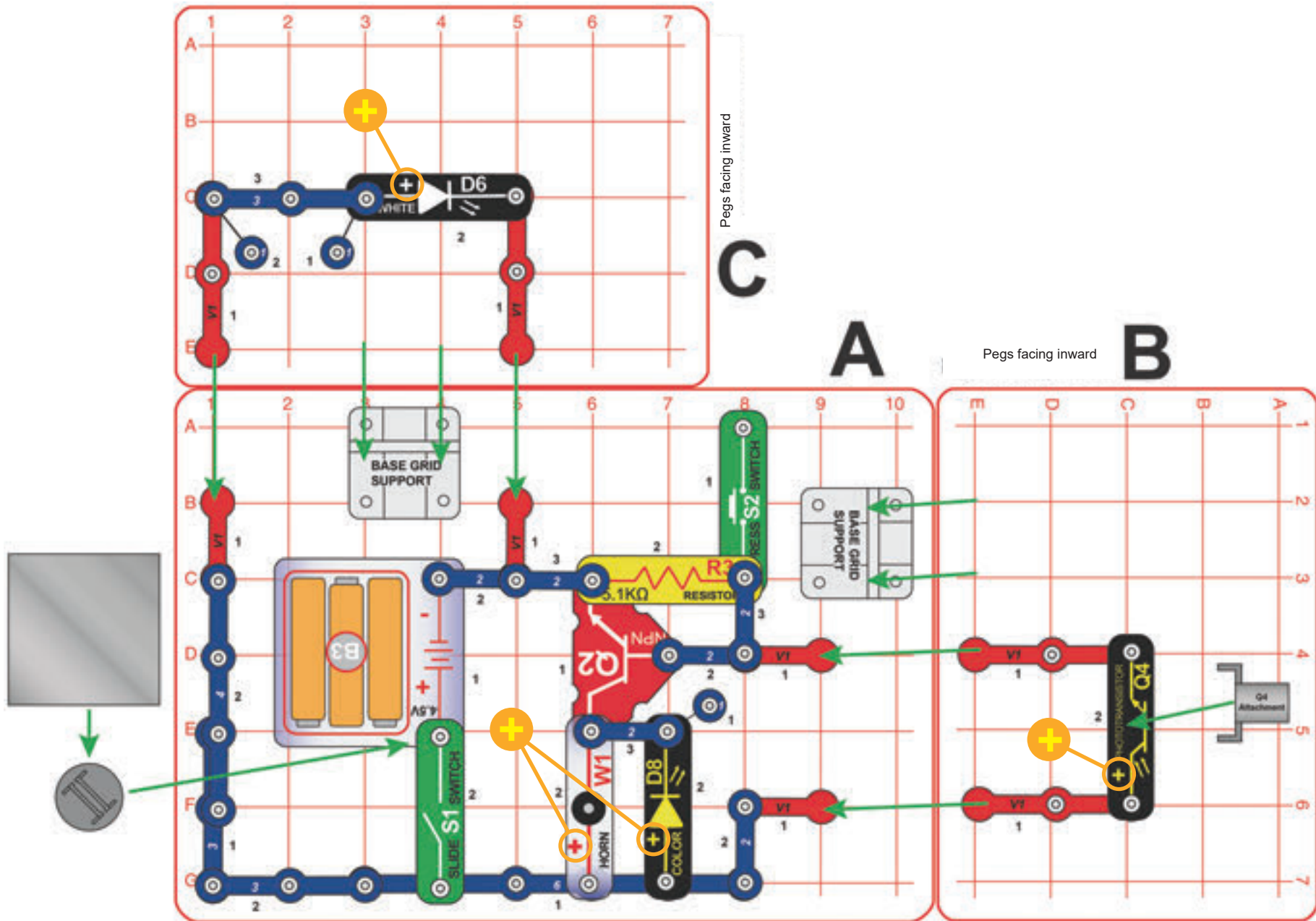

Assembly (adult supervision recommended):

1. Place base grid supports on the base grid labeled A in the drawing.
2. Place parts on grids B & C, and install into base grid supports on grid A.

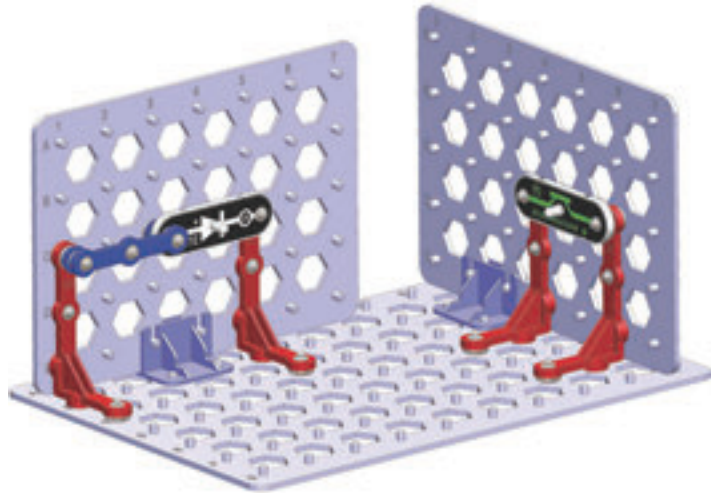

3. Install remaining parts on grid A.

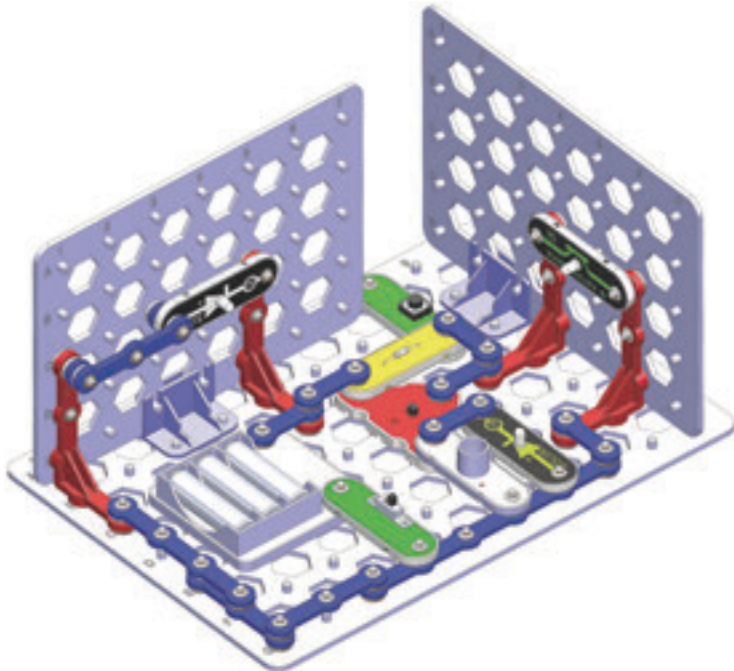

4. Add the mirror and Q4 attachment.

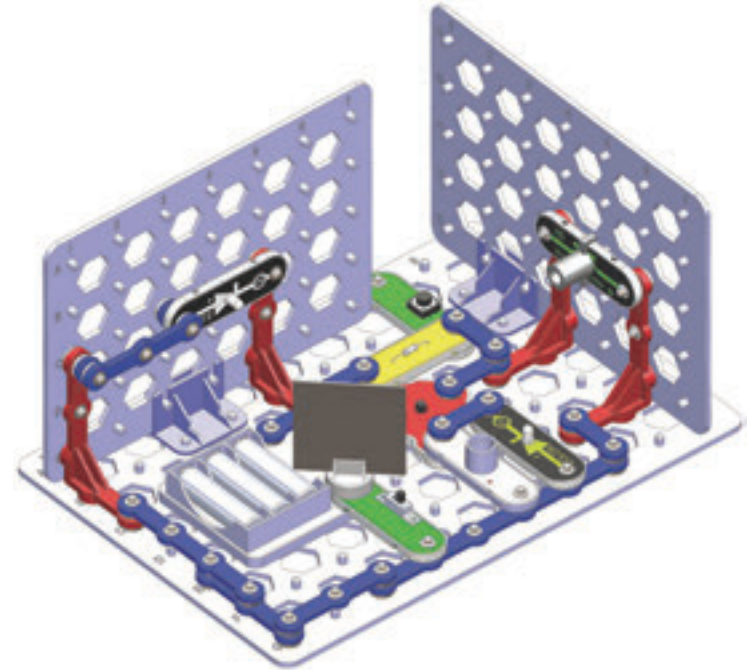

Turn on the slide switch (S1), and carefully align the mirror so light from the white LED (D6) reaches the phototransistor (Q4); an alarm will sound when you succeed. The press switch (S2) is used as a 1-snap wire, so pressing it has no effect.



The Q4 attachment helps prevent other lights in the room from triggering the phototransistor (Q4), so that the phototransistor is only activated by the color LED.



Project 24

One-Mirror Blinking Circuit

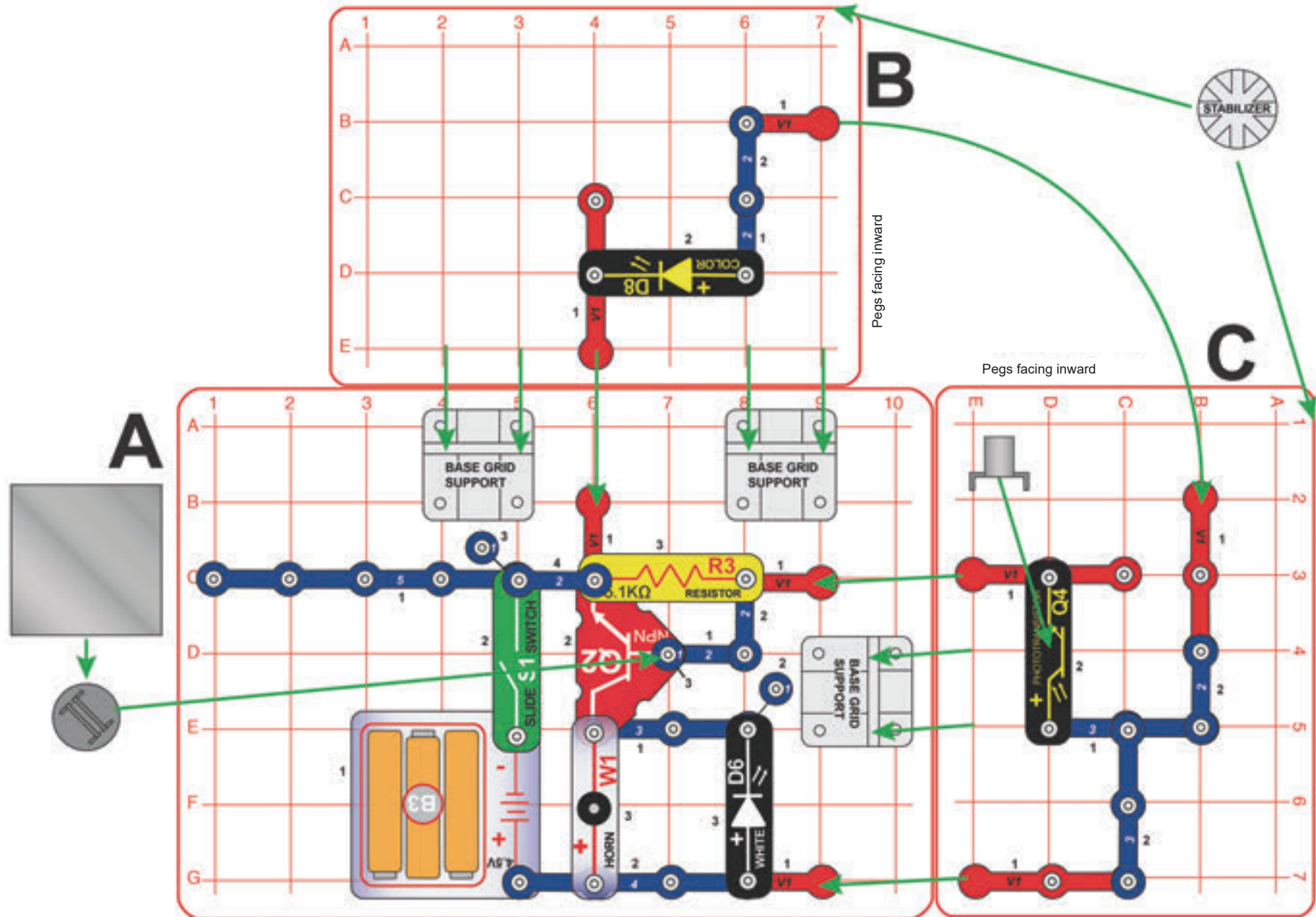

Follow these assembly instructions, in order, using the photo on the box cover (and the cover of this booklet) as a guide:

1. Place base grid supports on the base grid A.
2. Place parts on grid B, and install into base grid supports on grid A.
3. Place parts on grid C (except the vertical snap wire (V1) that connects to grid B), and install into base grid support on grid A.

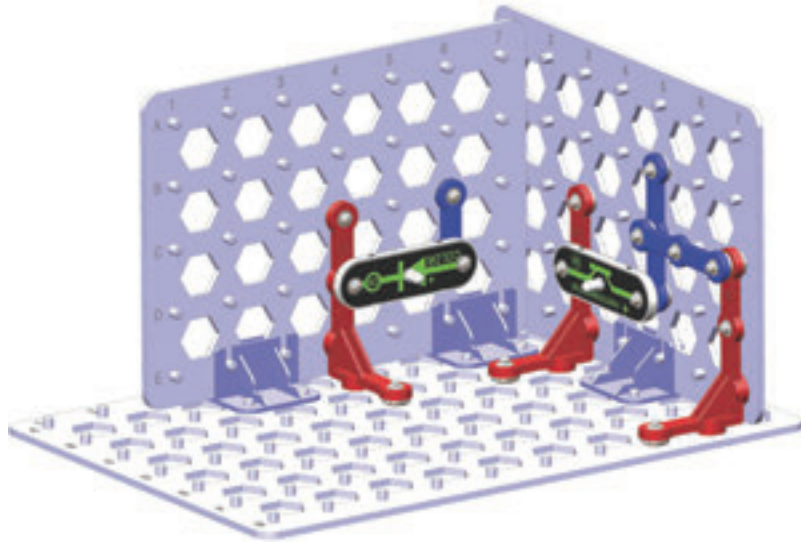

4. Finish connection of the V1 connecting between grids B-C, and add the stabilizer between grids B & C.

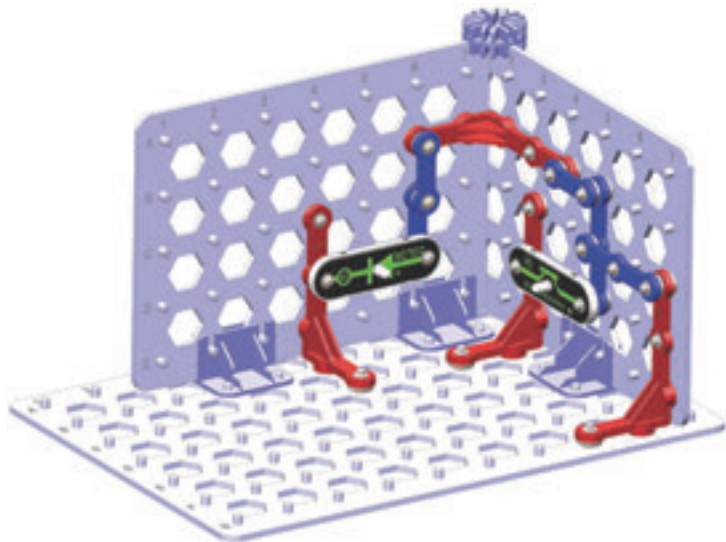

5. Install remaining parts on grid A, note that there is a 1-snap wire on top of the NPN transistor (Q2), on level 3.

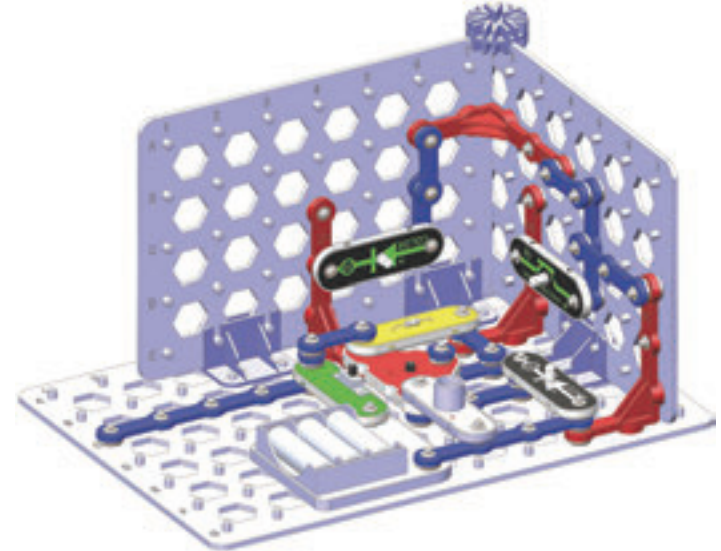

6. Add the mirror and Q4 attachment.

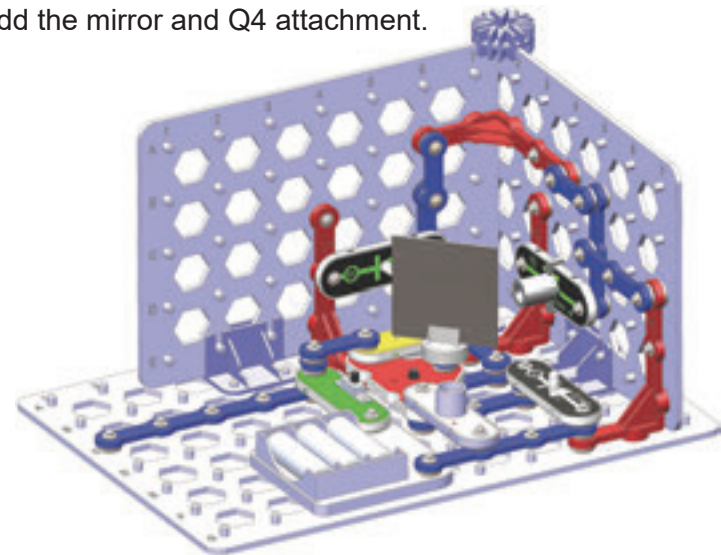

Turn on the slide switch (S1), and carefully align the mirror so light from the color LED (D8) reaches the phototransistor (Q4); an alarm will sound when you succeed. If desired, place the projector on the white LED to shine an image on the ceiling when the alarm sounds; it is best viewed in a dark room.



Project 25

3-Wall House

This circuit expands on the preceding one.
 Assembly (adult supervision recommended):

1. Place base grid supports on base grid A.
2. Place parts on base grids B, C, & D, and install into base grid supports on grid A. The pegs should be facing inward.
3. Mount grid E on top of grids B & C using 4 stabilizers, attaching the 3 vertical snap wires (V1) as you do it.
4. Place the remaining parts on grids A & E.

Turn on the slide switch (S1) to light the light tunnel (U30 and LEDs (D6 & D8)).



You can imagine this as a house, with the light tunnel as a TV, the white LED as an overhead light, and the color LED as a desk computer.

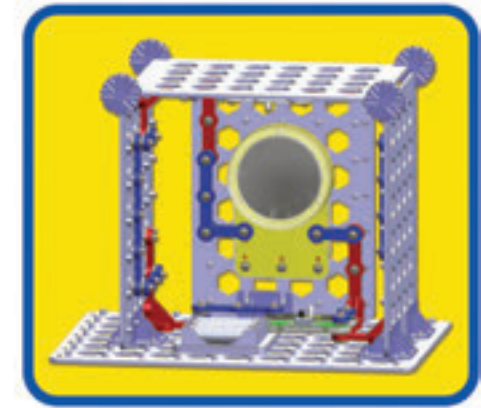
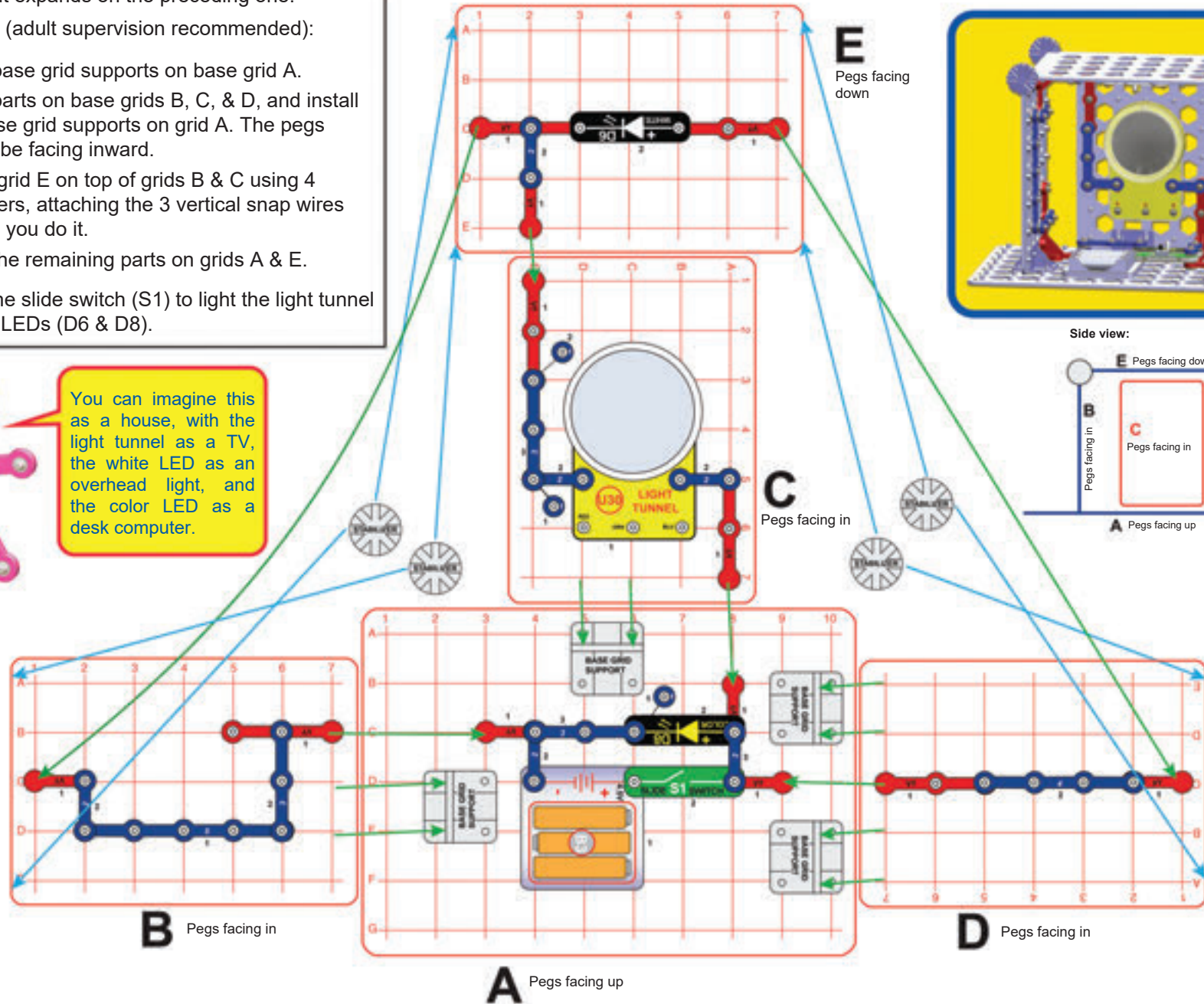

Side view:

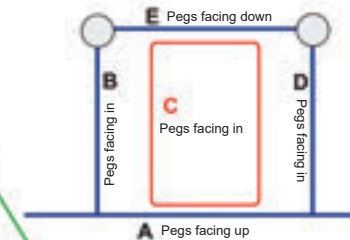

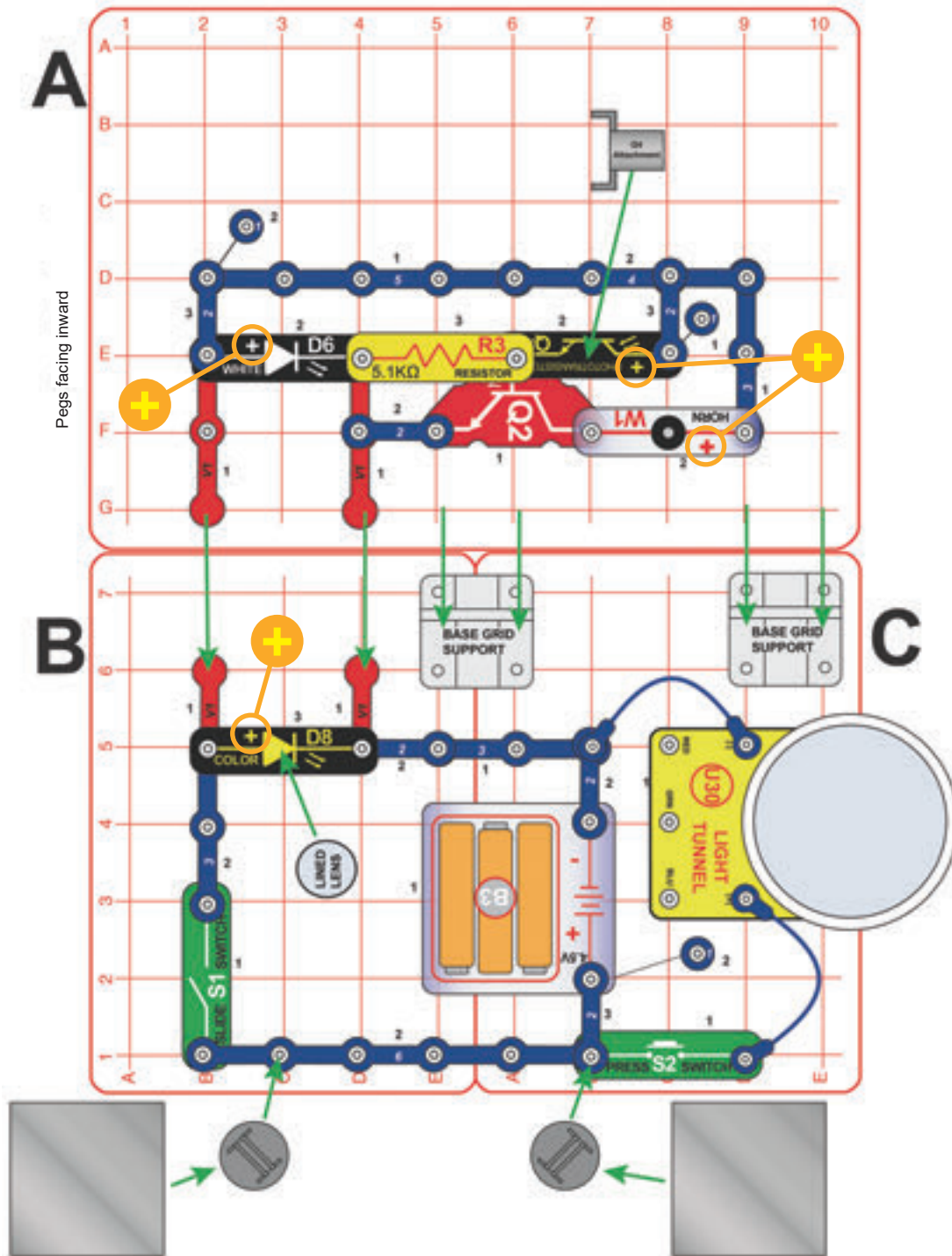

Project 26 Two-Mirror Circuit

Assembly:

1. Place base grid supports on base grids B & C. (Grids B & C are placed adjacent to make a full-size grid.)
2. Place parts on grid A, and install into base grid supports on grids B & C.
3. Install remaining parts on grids B & C.
4. Add the mirrors, lined lens, and Q4 attachment.

Turn on the slide switch (S1), and carefully align the mirrors so light from the white LED (D6) reaches the phototransistor (Q4); an alarm will sound when you succeed. Push the press switch (S2) to add light tunnel (U30) effects.

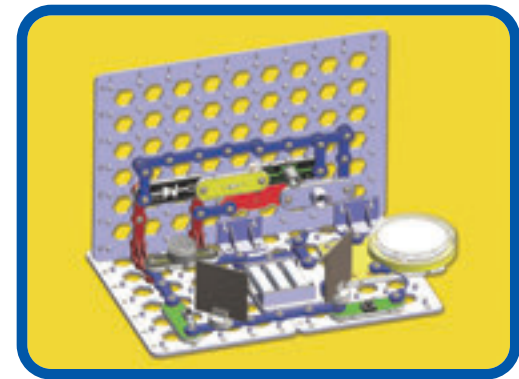

Project 27 Simple Two-Mirror Circuit

Use the preceding circuit but remove the color LED (D8) and the light tunnel (U30, and the blue jumper wires connecting it). D8 and U30 do not affect the mirror-alarm part of the circuit.



Project 28

Angled Roof House

Front-Side view:
Stabilizers are identified as F1-F3 and B1-B3
(Front 1-3 and Back 1-3), as shown on this
drawing.

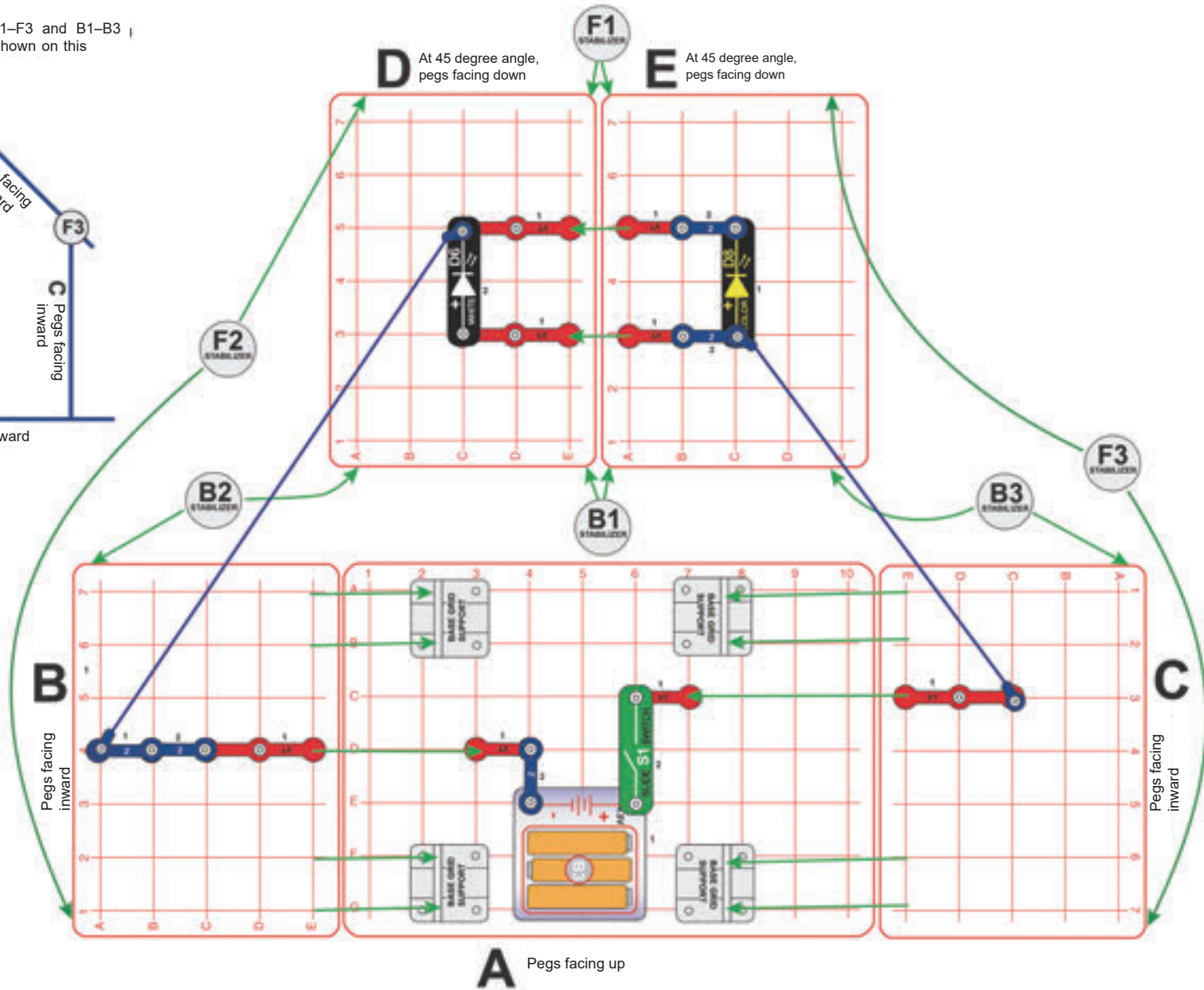
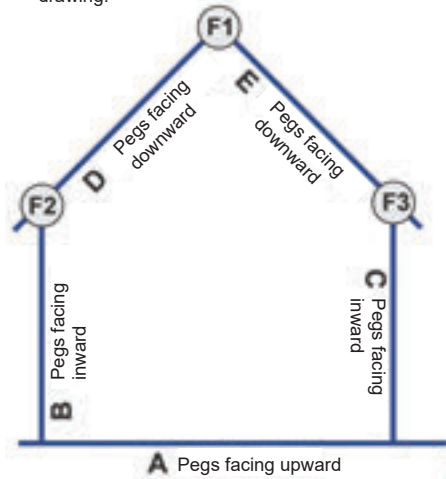

Assembly (adult supervision highly recommended):

1. Place base grid supports on base grid A.
2. Place parts (except for the blue jumper wires) on base grids B & C, and install into base grid supports on grid A. The pegs should be facing inward.

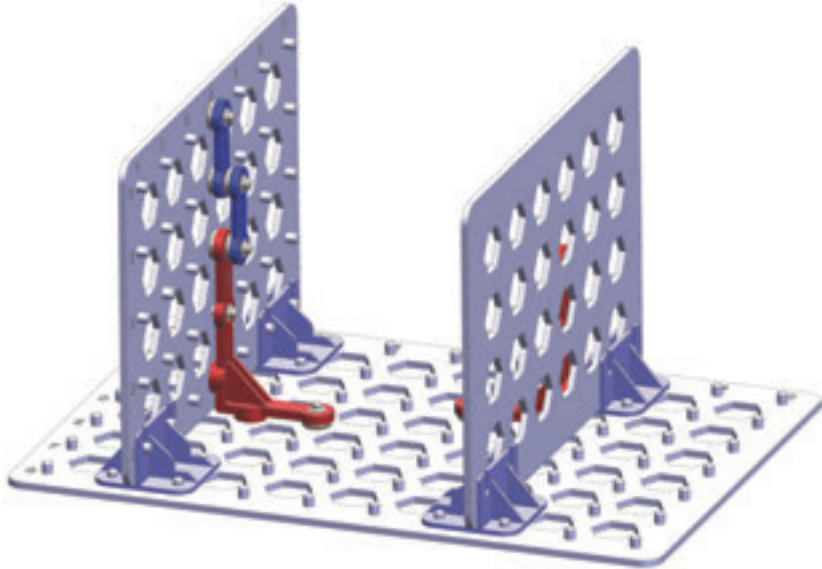

3. Place remaining parts on grid A.

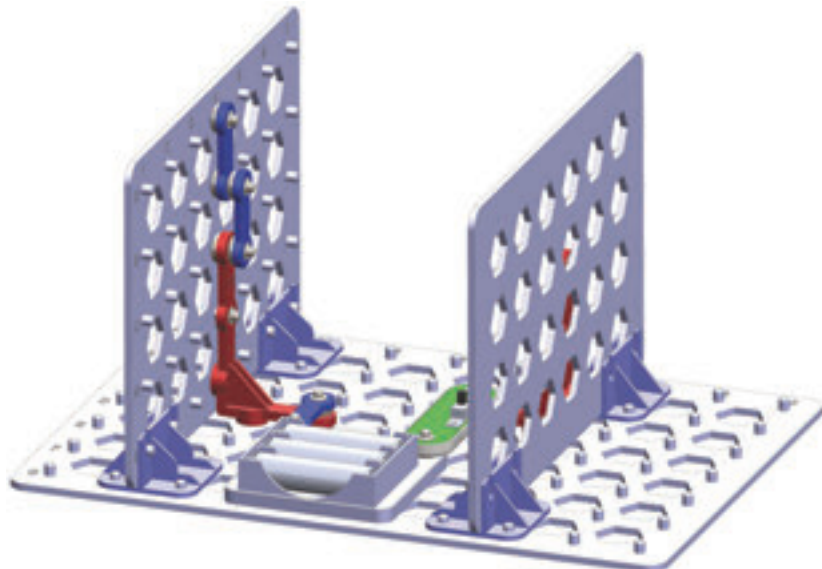

4. Mount grids D & E, at the angles shown and with pegs facing down, on top of grids B & C using 6 stabilizers, and attaching 2 vertical snap wires (V1) as you do it. Adjust the positions of the stabilizers as needed.
5. Add the remaining parts on grids D & E.

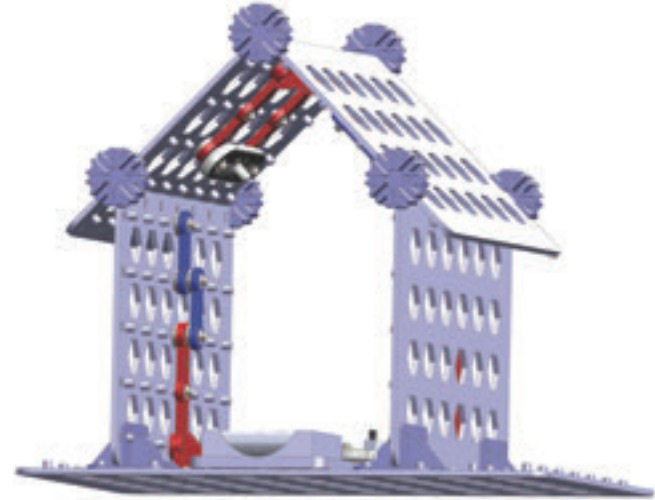

6. Add the 2 blue jumper wires.

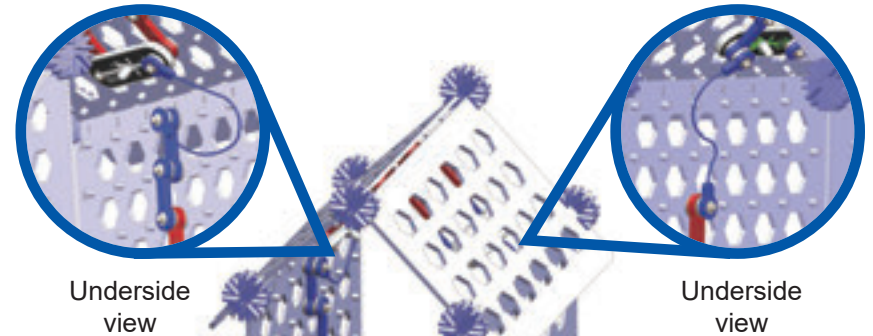

Turn on the slide switch (S1) to light the LEDs (D6 & D8).



Project 29

Break the Beam

Assembly:

1. Place base grid supports on base grid A.
2. Place parts on grids B & C, and install into base grid supports on grid A.
3. Install remaining parts on grid A.
4. Add the Q4 attachment.

Turn on the slide switch (S1); the white LED (D6) should be on. Now place your hand between the white LED and the phototransistor (Q4) and an alarm should sound.

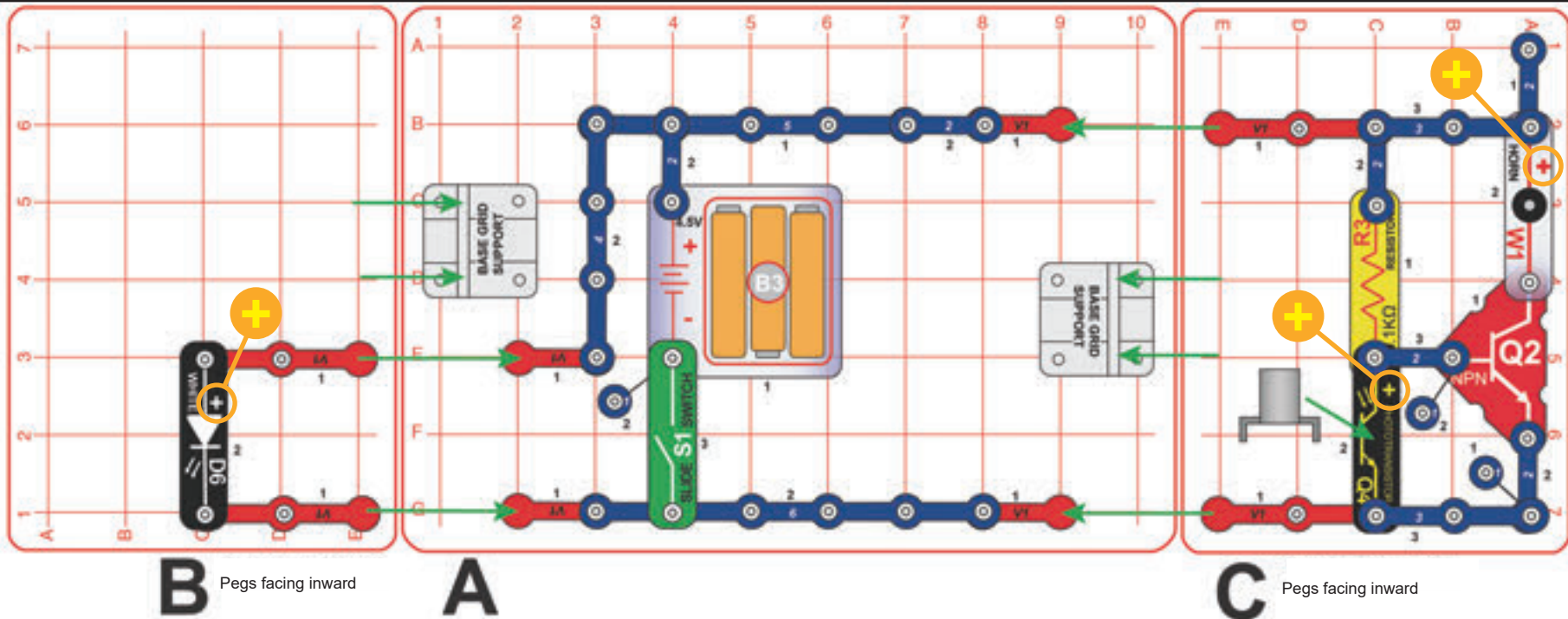

This circuit monitors the beam of light between the white LED and phototransistor. When you block the beam, it triggers an alarm. You could use a circuit like this to help guard your home from robbers.

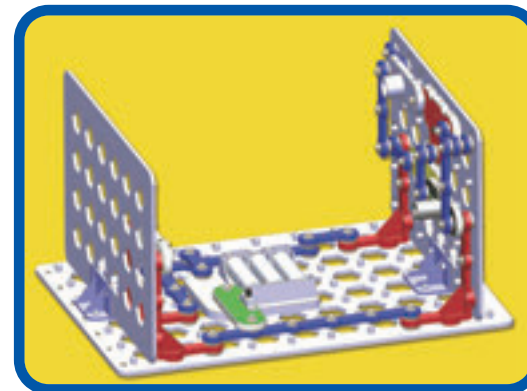



Project 30

Block the Sound

Assembly:

1. Place base grid supports on base grid A.
2. Place parts on grids B&C, and install into base grid supports on grid A.
3. Install remaining parts on grid A.

Turn on the slide switch (S1); the white LED (D6) and horn (W1) are on. Place your hand to block the light between the white LED and phototransistor (Q4); the sound stops. If the sound is on even if you block the light from the white LED then room light may be keeping it on, try pointing the phototransistor away from room light.

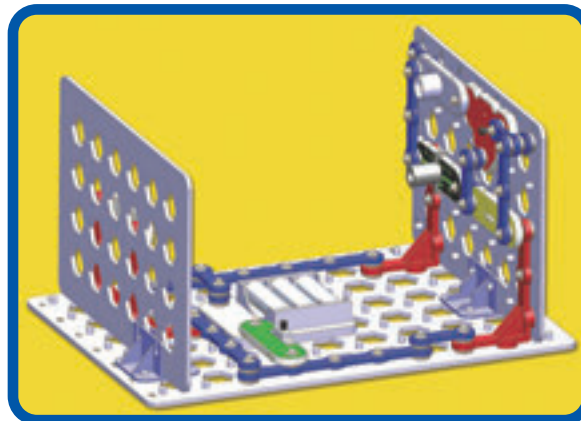
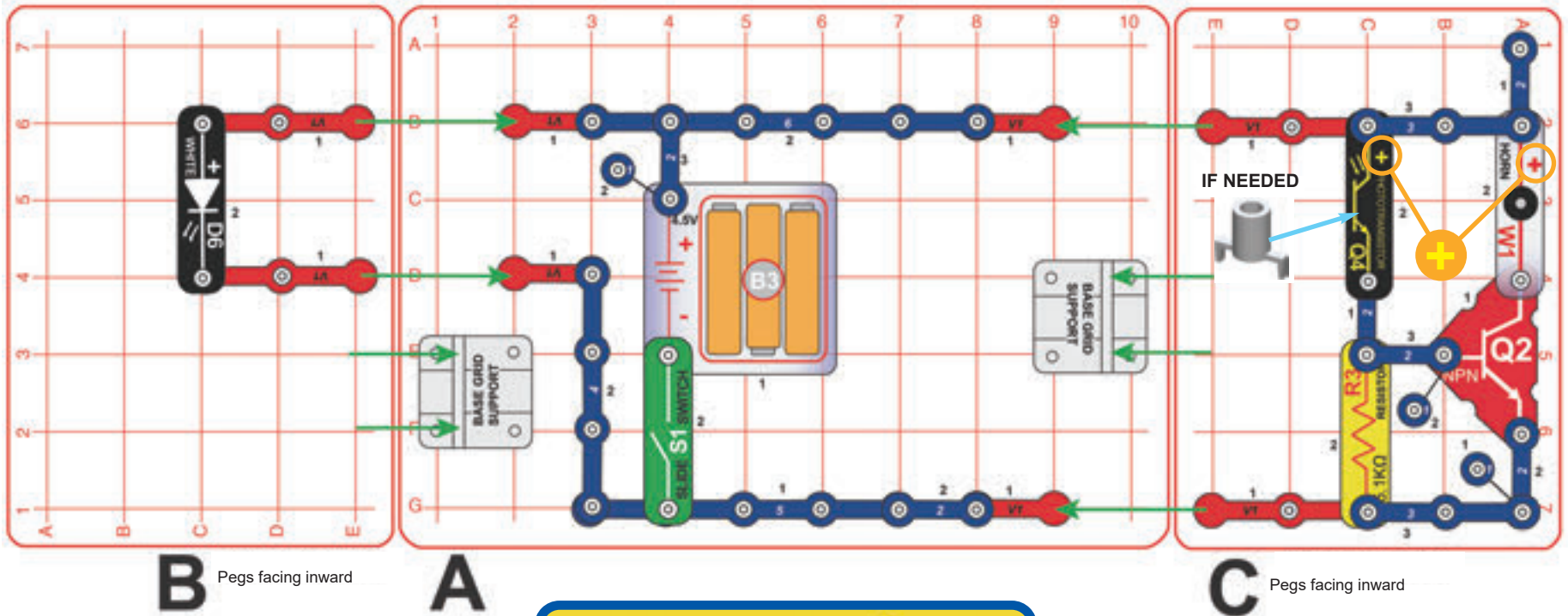



Project 31

Light & Sound

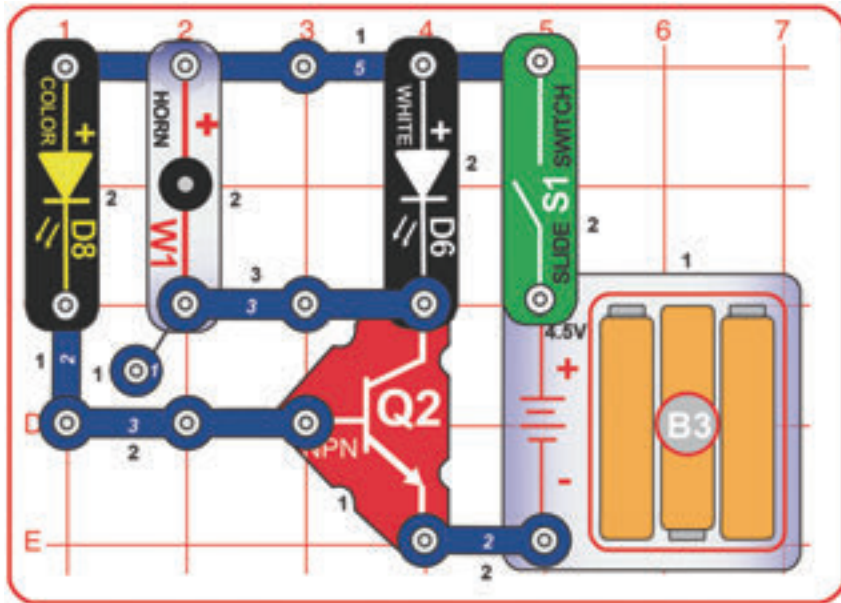

Turn on the slide switch (S1) to get a light display with funky sounds. For added effects, place the lined lens attachment on the color LED (D8), place the circuit so that the color LED is next to a wall or box, and dim the room lights. For best effects turn the clear part of the lined lens so that the lines on it converge towards the left.



Project 32 A New Light & Sound

Use the project 31 circuit but swap the locations of the white LED (D6) and color LED (D8).

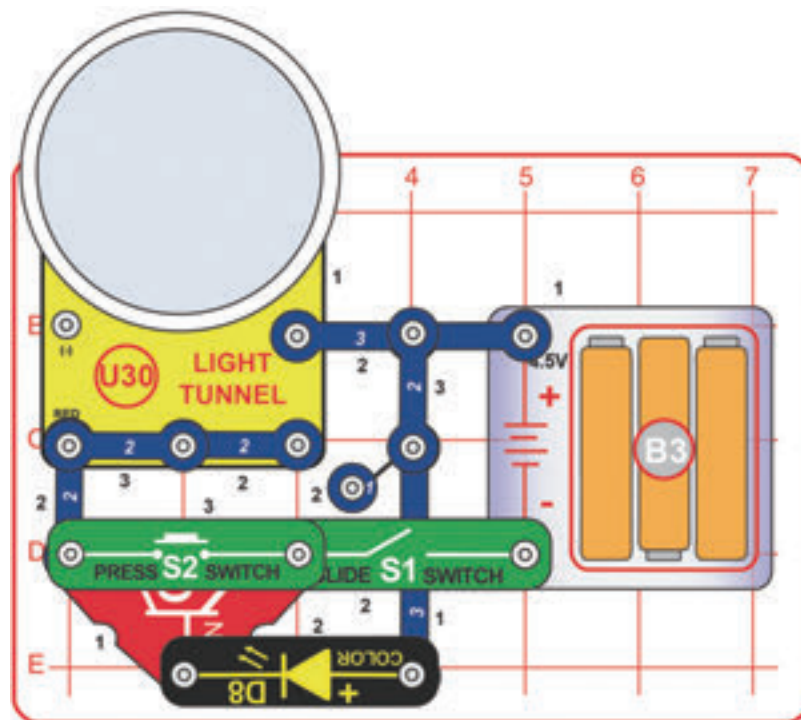

Project 33 Light Tunnel

Turn on the slide switch (S1). The light tunnel (U30) is blinking. For best effects, dim the room lights. Try GENTLY pressing on the center of the mirror in the light tunnel, and notice how the light patterns bend inward a little. Push the press switch (S2) to stop the blinking effect.

Project 34

3D Color

Put on the 3D color glasses and look at the ConQuest entertainment text on the right (with black background). Notice how the red printing seems to come to the front, while the blue printing seems to go to the back.



These are not normal 3D glasses like those in movie theaters. They have a special film that diffracts colors differently, making an image appear to have visual depth. Colors like red appear closer, and colors like blue appear farther away. Sharp color contrasts produce better effects than smooth color transitions, so artificial images work better than natural images.



Project 35

3D Color Mess

Put on the 3D color glasses and look at the text mess at right (with black background). Notice how the red printing seems to come to the front, while the blue printing seems to go to the back.

Project 36

3D Color LEDs

Build projects 1-2 and view the color and white LEDs through the 3D color glasses. You see some interesting effects.

Project 37

Your 3D Color

View stuff around your home through the 3D color glasses, including your computer or TV. Sharp contrasts between red, blue, green and yellow give the most interesting effects. Try making your own drawings. Have a contest with your friends to see who can make the most interesting image.



Project 38
3D Color Splat

Put on the 3D color glasses and look at this picture. Notice how the red seems to come to the front, while the blue seems to go to the back.

Project 39
3D Color Fun

Put on the 3D color glasses and look at this picture. Notice how the red seems to come to the front, while the blue seems to go to the back.

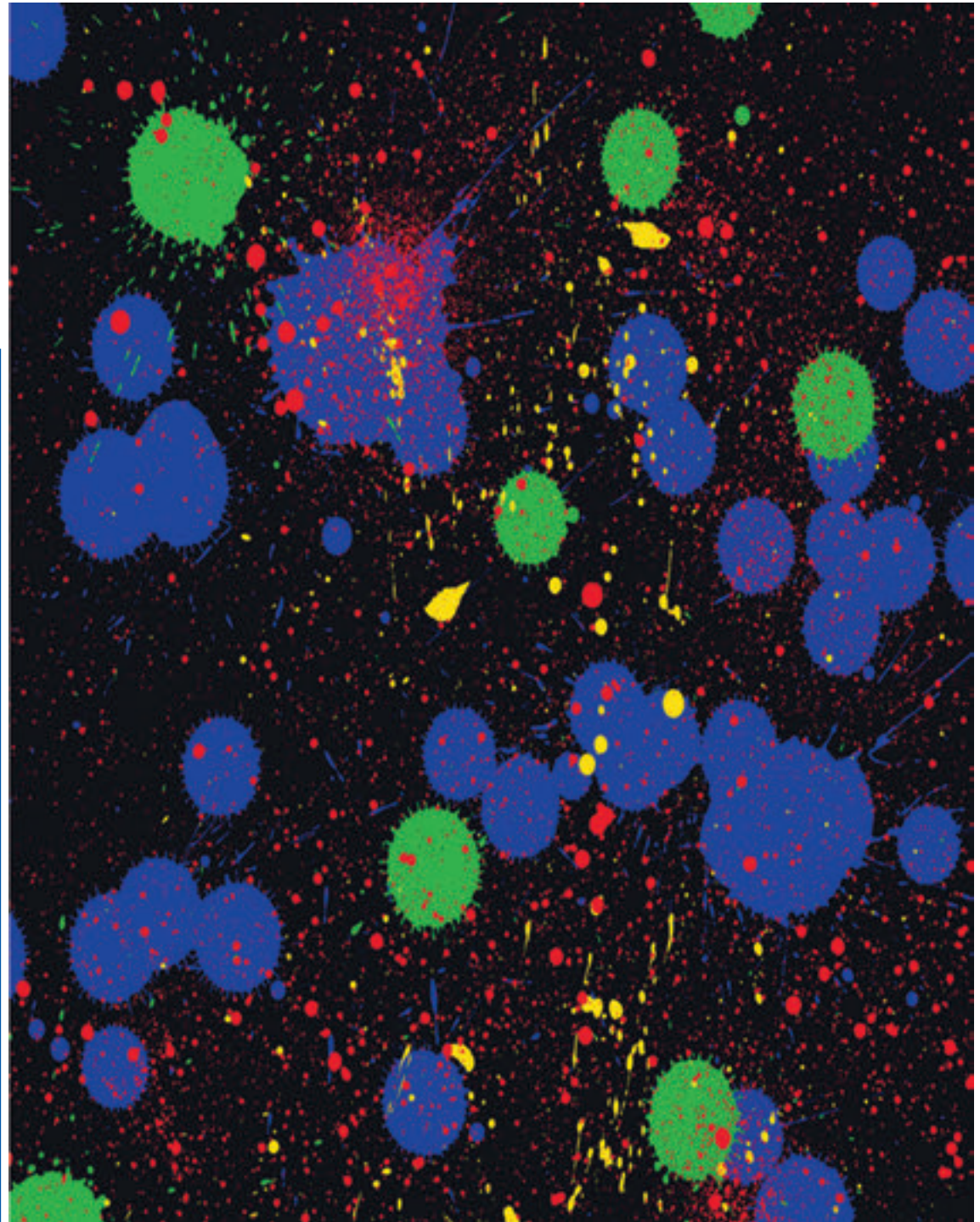



Project 40

3D Color Tech

Put on the 3D color glasses and look at these pictures. Notice how the red seems to come to the front, while the blue seems to go to the back.

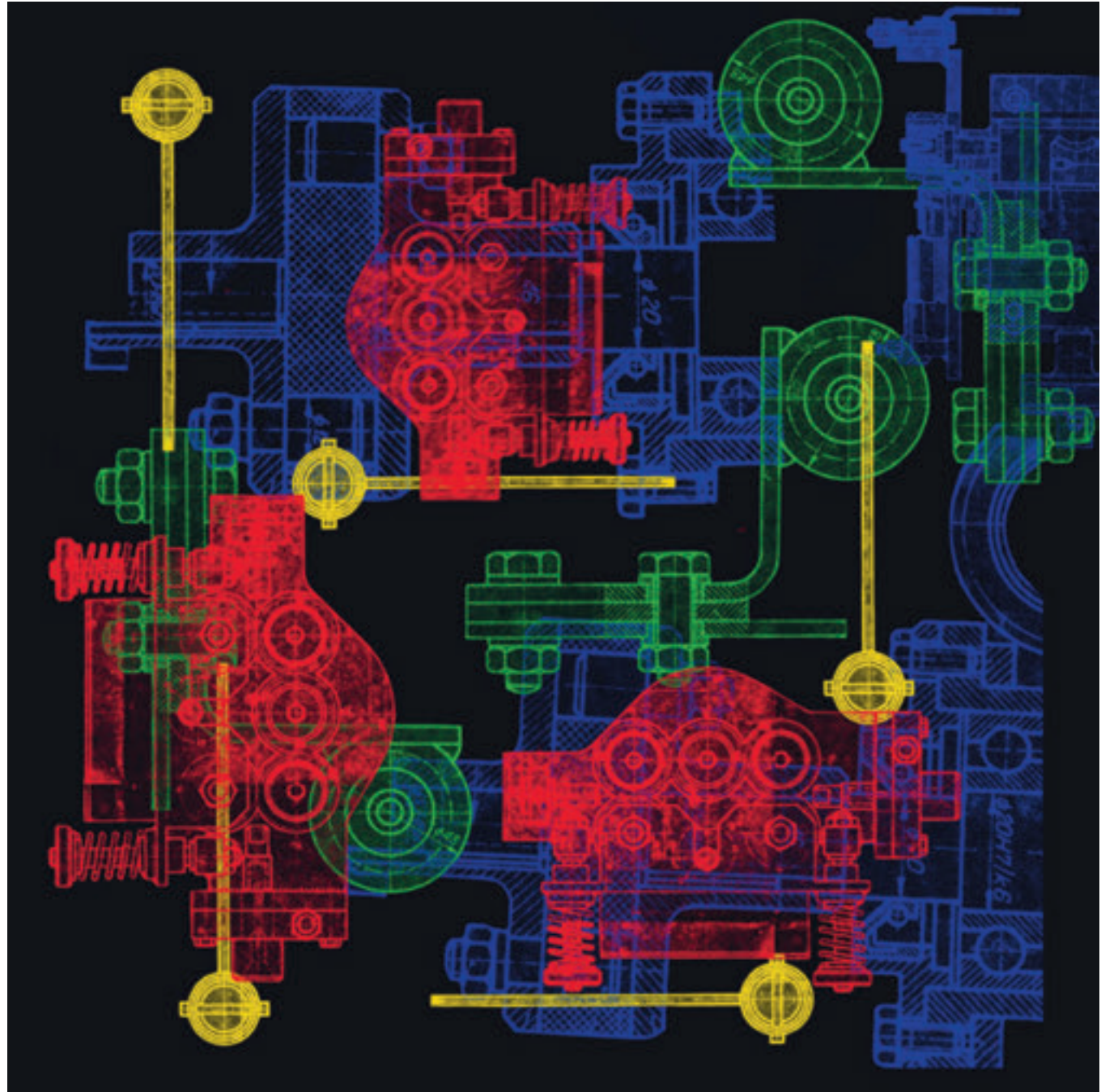



Project 41

3D Color T-Rex

Put on the 3D color glasses and look at these pictures. Notice how the red seems to come to the front, while the blue seems to go to the back.



Project 42

Automatic Light

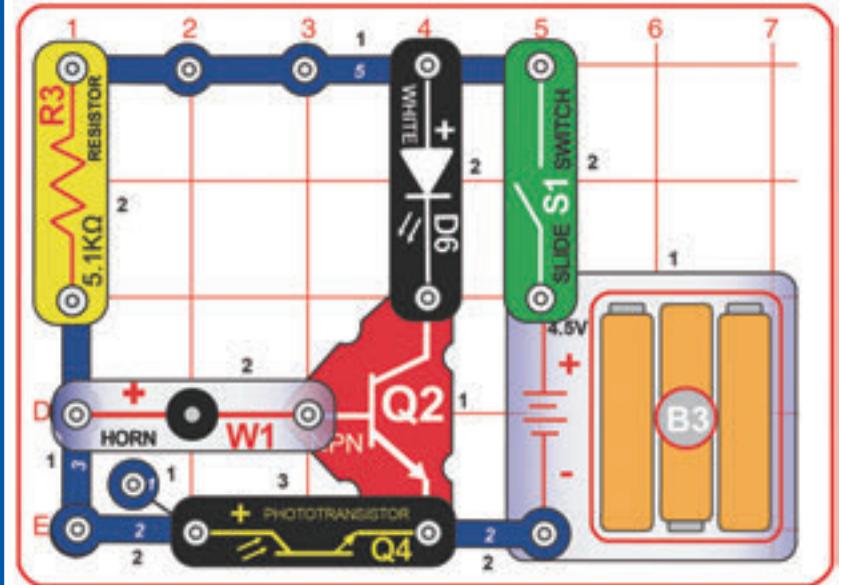

Build the circuit and turn on the slide switch (S1). The white LED (D6) will be on unless there is bright light on the phototransistor (Q4), so vary the amount of light shining on the phototransistor. The horn (W1) will not make any sound (it is used here to help control the phototransistor current).

This circuit automatically turns on the light when the room starts getting dark.





Project 43

Elevated Automatic Light

Use the preceding circuit, but mount it up high so it so the phototransistor (Q4) can better measure the room light to see if the white LED (D6) needs to come on.

Assembly (adult supervision recommended):

1. Place base grid supports on base grid A.

2. Install grids B & C into base grid supports on grid A. The pegs on grids B & C should be facing outward.

3. Place parts on grids D as shown in project 42.

4. Mount grid D on top of grids B & C using 4 stabilizers.

The circuit works the same as in project 42.

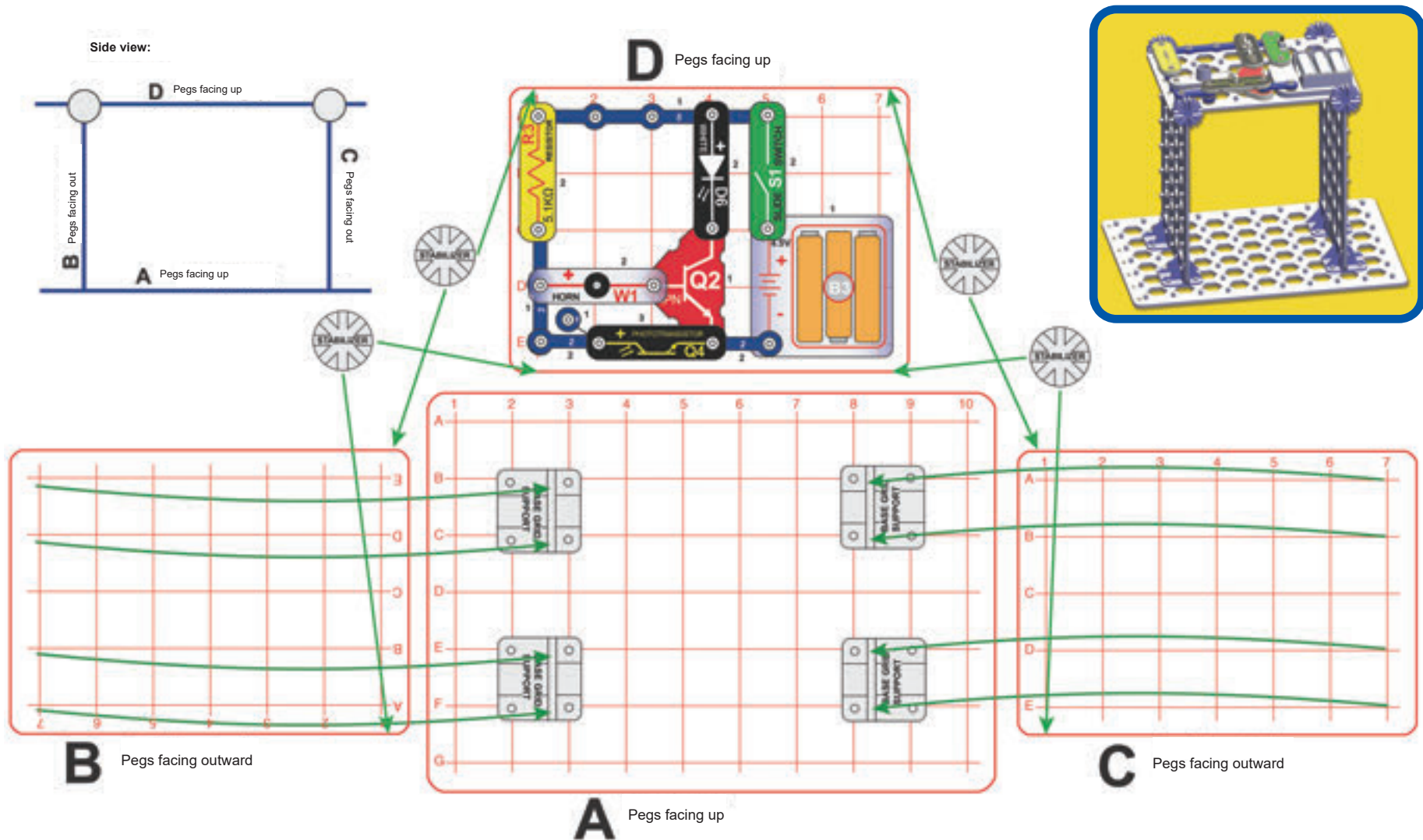



Project 44

Automatic Lights

Use the preceding circuit, but add some lights on the sides, as shown.

Assembly (adult supervision recommended):

1. Place base grid supports on base grid A.
2. Place parts on grids B & C (except jumper wires), and install into base grid supports on grid A. The pegs on grids B & C should be facing outward.
3. Place parts (except jumper wires) on grids A & D. There are only a few changes to the parts on grid D compared to project 43.

4. Mount grid D on top of grids B & C using 4 stabilizers.
5. Add the jumper wires (2 blue, 1 red, and 1 black).

Turn on the slide switch (S1). The LEDs (D6 & D8) and the light tunnel (U30) will be on unless there is bright light on the phototransistor (Q4), so vary the amount of light shining on the phototransistor.

The horn (W1) will not make any sound (it is used here to help control the phototransistor current).

Side view:

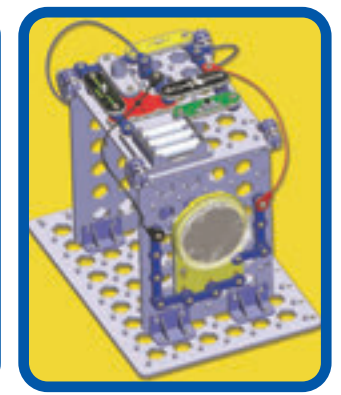
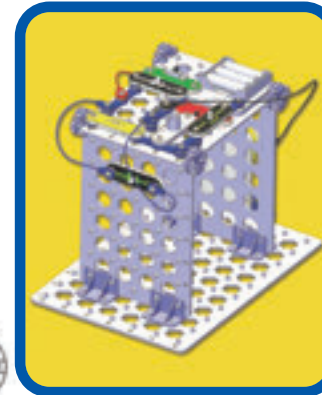
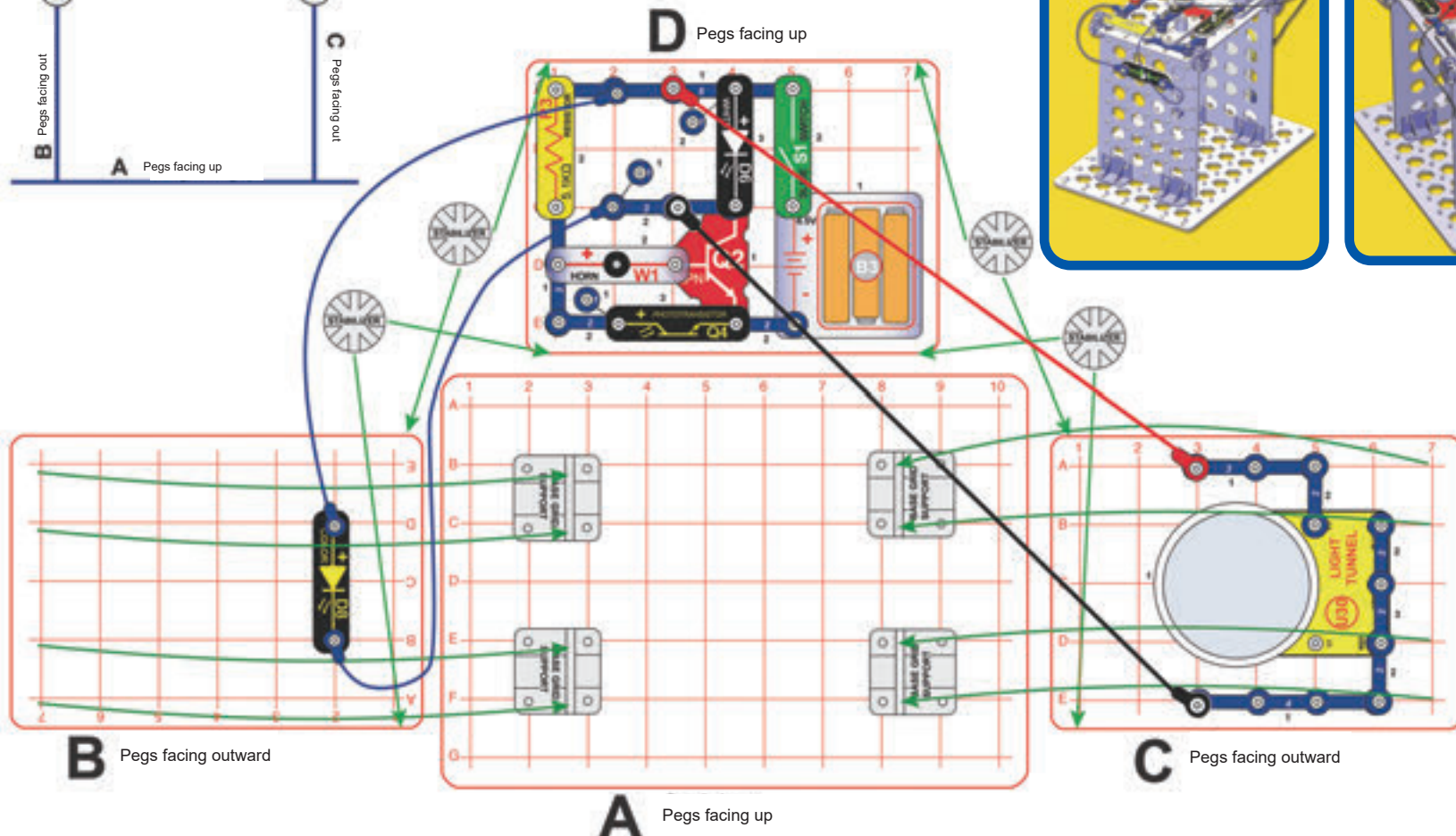
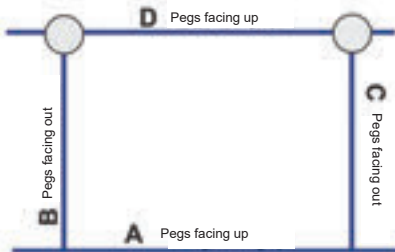

Project 45

Super Automatic Lights

Use the preceding circuit, but change the connections to the light tunnel (U30), as shown. Now the light tunnel changes its pattern.

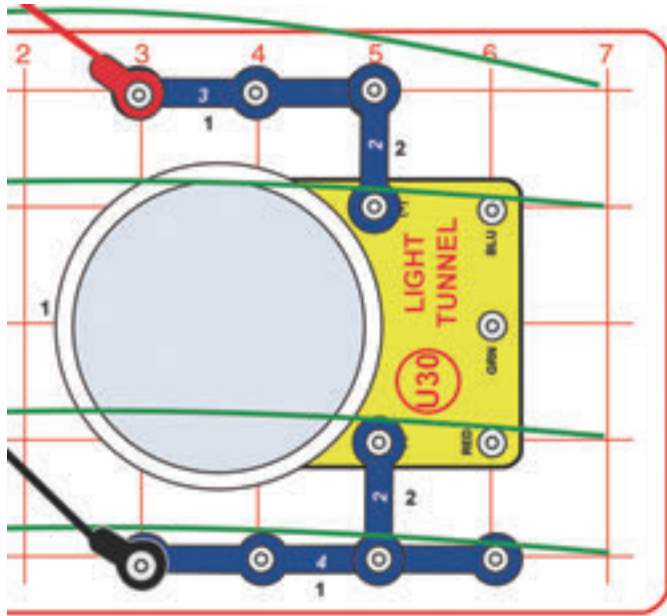

Assembly:

1. Place base grid supports on base grid B.
2. Place parts on grid A, and install into base grid supports on grid B.
3. Install remaining parts on grid B.

Turn on the slide switch (S1), and enjoy the show from the light tunnel (U30). For best effects, position the circuit to shine across a dimly lit room.

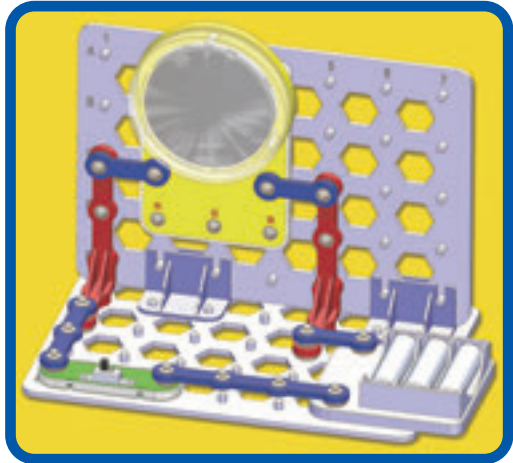

Project 46

Vertical Light Tunnel

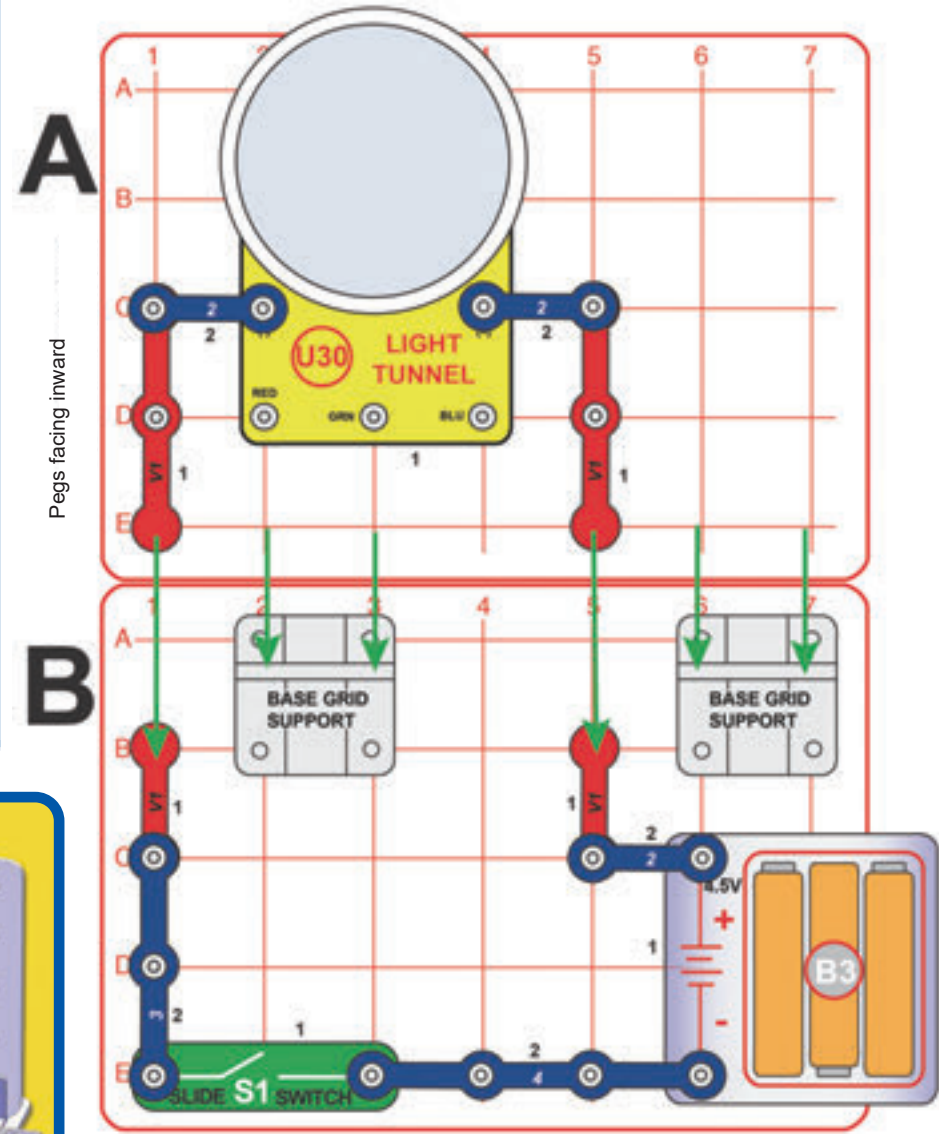



Project 47

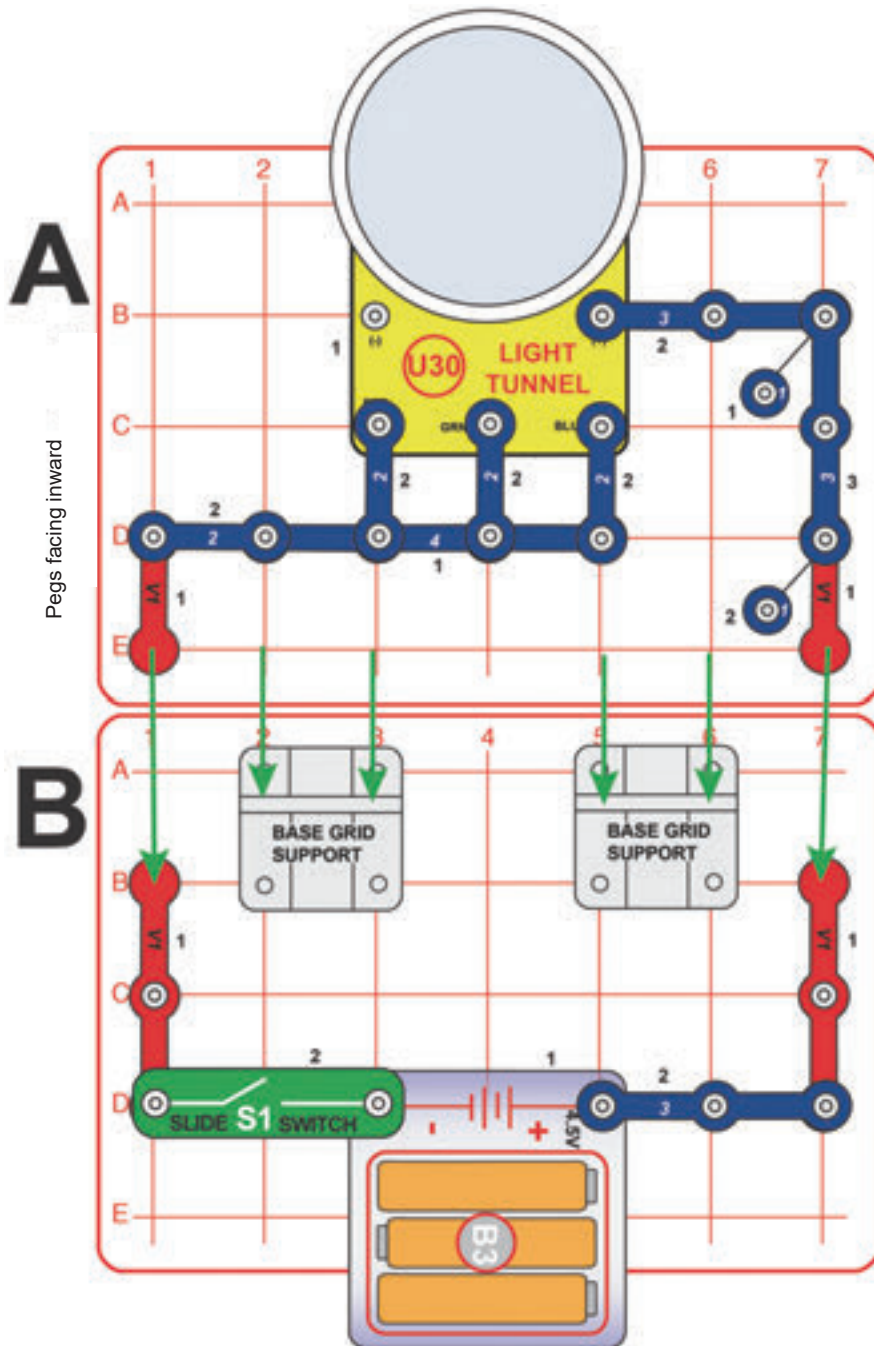

Vertical Tri-Color Light Tunnel

Assembly:

1. Place base grid supports on base grid B.
2. Place parts on grid A, and install into base grid supports on grid B.
3. Install remaining parts on grid B.

Turn on the slide switch (S1), all the lights in the light tunnel (U30) are on. For best effects, position the circuit to shine across a dimly lit room.

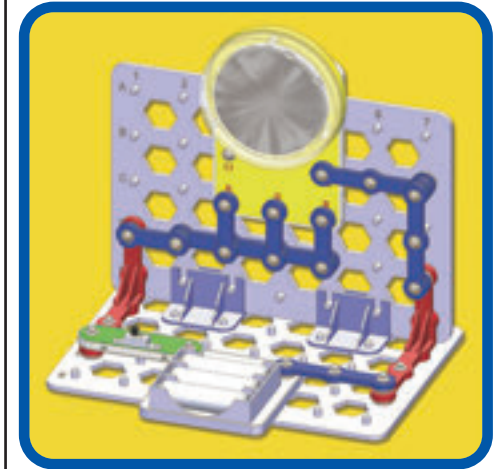

Project 48 Vertical Dual-Color Light Tunnel

Use the preceding circuit but remove one of the 2-snap wires connecting to the light tunnel (U30).



Project 49 Vertical Single-Color Light Tunnel

Use the project 47 circuit but remove two of the 2-snap wires connecting to the light tunnel (U30).



Project 50

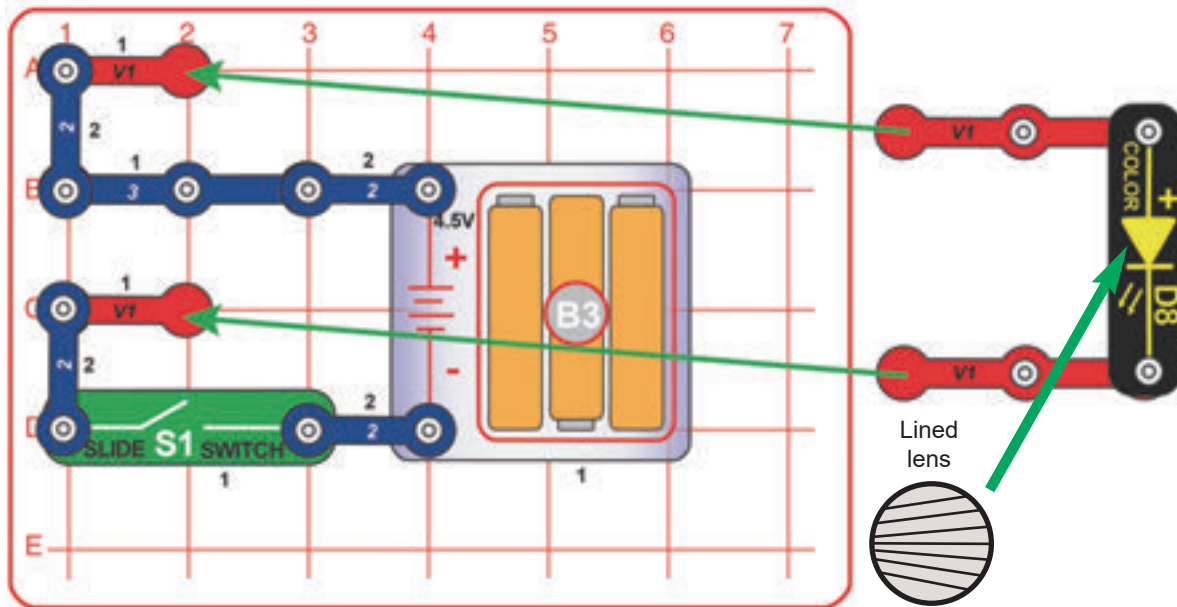

Wall Light Show

Use two vertical snap wires (V1) and mount the color LED (D8) on them so it will shine towards a wall, then place the lined lens on the color LED. Place the circuit in a dark room and point it towards a wall, white walls give best effects. Turn on the slide switch (S1) and rotate the clear part of the lined lens to see how the light show changes. The room should be very dark for best effects. You can also get good results by projecting the light on a white box a few feet away.

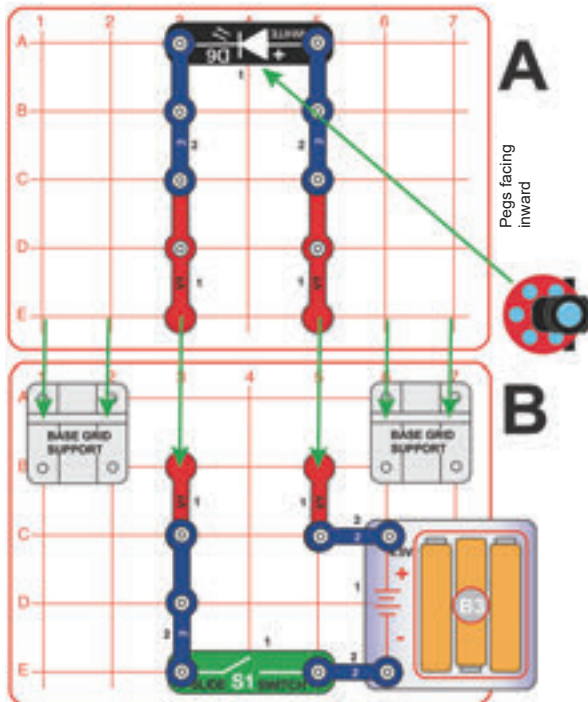

Project 51 Wall Projector



Assembly:

1. Place base grid supports on base grid B.
2. Place parts on grid A, and install into base grid supports on grid B. Note that the pairs of red pieces marked "V1" on both grids are the same parts (vertical snap wires), mounted in different dimensions.
3. Install remaining parts on grid B.
4. Place the projector on the white LED (D6), with the red knob facing up.

Place the circuit in a dark room and point it towards a wall, white walls give best effects. Turn on the slide switch (S1) and turn the knob on the projector to show the 6 images on the wall. The room should be very dark for best effects. You can also get good results by projecting the images on a white box a few feet away.



Project 52

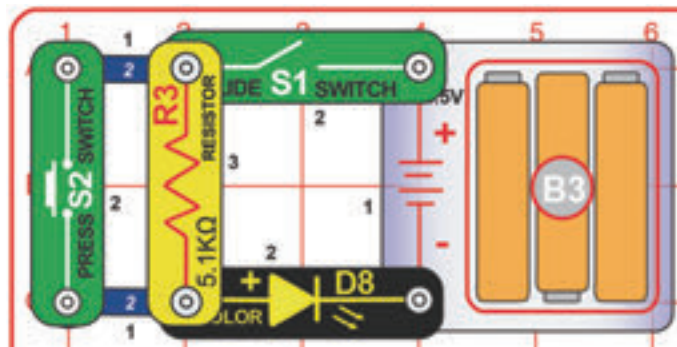

Resistors are used to control or limit the flow of electricity in a circuit. In this circuit, the 5.1kΩ resistor (R3) reduces the LED brightness, making the batteries last longer. What is Resistance? Take your hands and rub them together very fast. Your hands should feel warm. The friction between your hands converts your effort into heat. Resistance is the electrical friction between an electric current and the material it is flowing through.



Dim Color Light

Build the circuit as shown and turn on the slide switch (S1); the color LED (D8) will be dim. Push the press switch (S2) to make the LED much brighter.



Project 53

Dim White Light

Replace the color LED (D8) with the white LED (D6).



Project 54

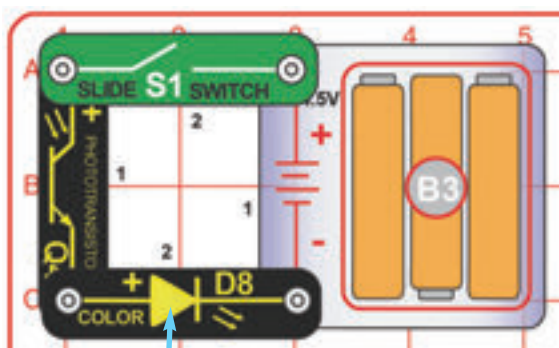

The phototransistor uses light to control electric current. As more light shines on the phototransistor, the current through it increases, making the LED brighter.



Light-Controlled Light

Turn on the slide switch (S1) and vary the amount of light shining on the phototransistor (Q4). The brighter the light on the phototransistor, the brighter the color LED (D8) should be. The Q4 attachment is placed on D8, to make it easier to see if it is dim.



Project 55

Light-Controlled White Light

Replace the color LED (D8) with the white LED (D6). Compared to the color LED, the white LED requires more light on Q4 to turn on, but gets brighter when there is a lot of light on Q4.



Project 56

Dim Green Light Tunnel

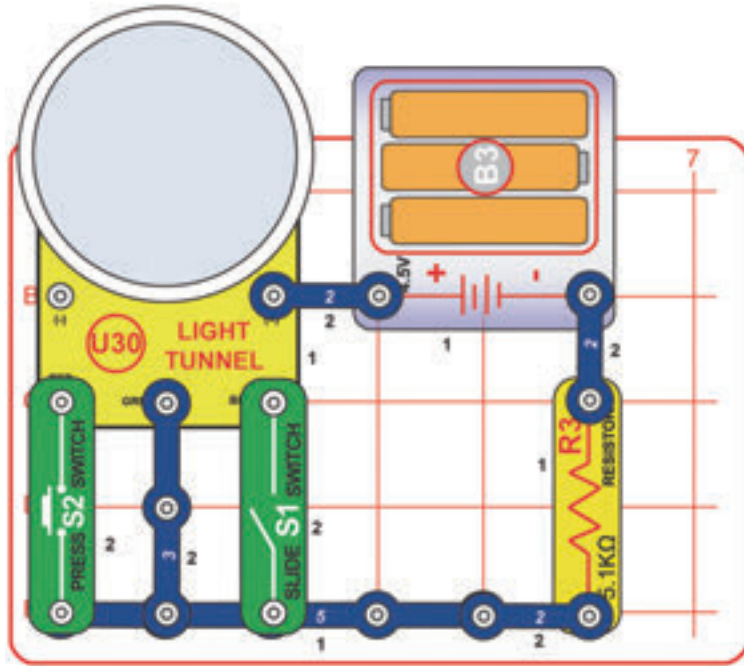

Build the circuit as shown; the green lights in the light tunnel (U30) should be on but dim.
 Push the press switch (S2); the red lights are on dimly but the green lights are off.
 Turn on the slide switch (S1); nothing changes (the green lights are still on dimly). Do you know what is happening here?
 This circuit does not have an on/off switch, so disconnect it when you are finished to avoid draining your batteries.

The 5.1kW resistor (R3) is limiting the flow of electricity through the light tunnel LEDs, making them dim. Electricity from the batteries splits up among the light tunnel LEDs (initially the three green ones), then recombines and flows through the resistor and back to the batteries.
 Pushing the press switch adds the red LEDs to the circuit. Red LEDs turn on more easily than green ones, so all the electricity flows through the red ones instead of the green ones.
 Turning on the slide switch adds the blue LEDs to the circuit. Blue LEDs do not turn on as easily as the green ones, so almost all the electricity keeps flowing through the green ones (and the blue ones are ignored).



Project 57 Dim Red Light Tunnel

Use the preceding circuit, but swap the locations of the 3-snap wire and press switch (S2). The red LEDs in the light tunnel (U30) should be on but dim.
 Push the press switch (S2) to add the green LEDs to the circuit, or turn on the slide switch (S1) to add the blue LEDs to the circuit; nothing happens (the green & blue LEDs stay off).

Red LEDs turn on more easily than green or blue ones, so almost all the electricity keeps flowing through the red ones if you turn on the press or slide switches (the green & blue LEDs are ignored).



Project 58 Dim Blue Light Tunnel

Use the project 56 circuit, but swap the locations of the 3-snap wire and slide switch (S1). The blue LEDs in the light tunnel (U30) should be on but dim.
 Push the press switch (S2) to add the red LEDs to the circuit, or turn on the slide switch (S1) to add the green LEDs to the circuit. The blue LEDs go off when you do this.

Red or green LEDs turn on more easily than blue ones, so almost the electricity flows through the red or green ones if you turn on the press or slide switches, and the blue LEDs are ignored.



Project 59 Bright Light Tunnel

Use the project 56 circuit, but replace the 5.1kW resistor (R3) with a 3-snap wire. The green LEDs in the light tunnel (U30) should be on brightly.
 Push the press switch (S2) to add the red LEDs to the circuit, or turn on the slide switch (S1) to add the blue LEDs to the circuit.

The 5.1kW resistor is no longer limiting the flow of electricity, so all the LEDs are able to shine brightly.





Project 60 **Blinking Blue Light Tunnel**

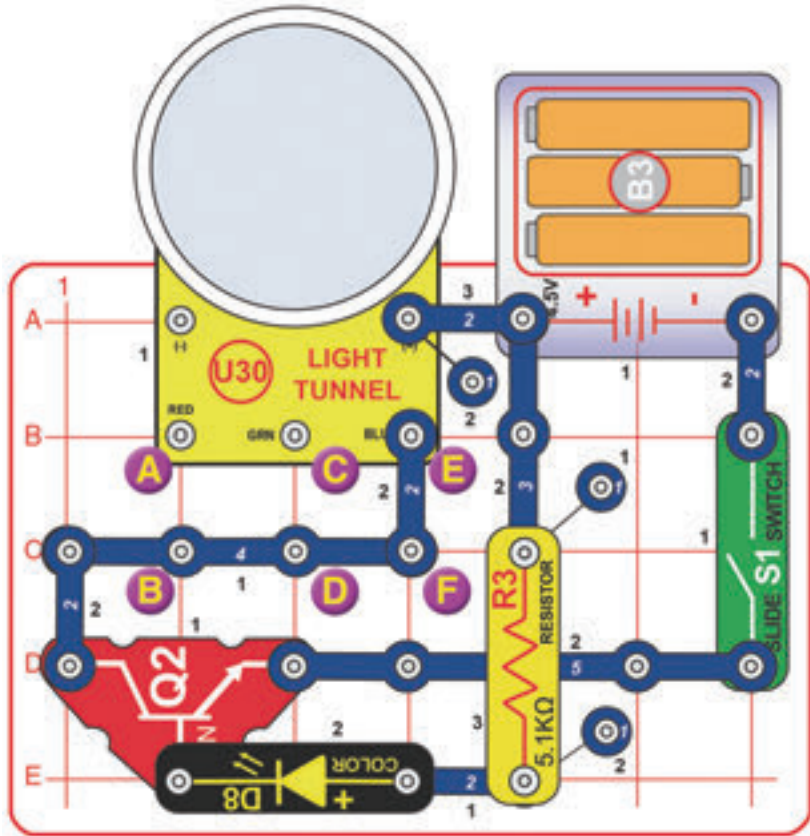

Turn on the slide switch (S1). The blue LEDs in the light tunnel (U30) are blinking, and are in sync with the color LED (D8). For best effects, dim the room lights.



Project 61 **Blinking Red Light Tunnel**

Use the project 60 circuit, but move the 2-snap wire from the points marked E & F to points A & B.



Project 62 **Blinking Green Light Tunnel**

Use the project 60 circuit, but move the 2-snap wire from the points marked E & F to points C & D.



Project 63 **Blinking Red & Blue Light Tunnel**

Use the project 60 circuit, but add a 2-snap wire across points A & B.



Project 64 **Blinking Green & Blue Light Tunnel**

Use the project 60 circuit, but add a 2-snap wire across points C & D.



Project 65 **Blinking Red & Green Light Tunnel**

Use the project 60 circuit, but remove the 2-snap wire across points E & F, and add 2-snap wires across points A & B, and C & D.



Project 66

Front & Back Circuit

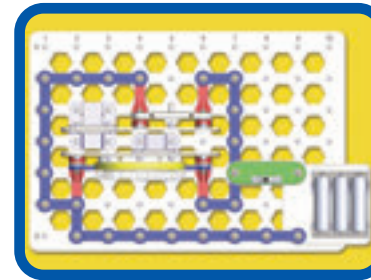

Top view



Rear view

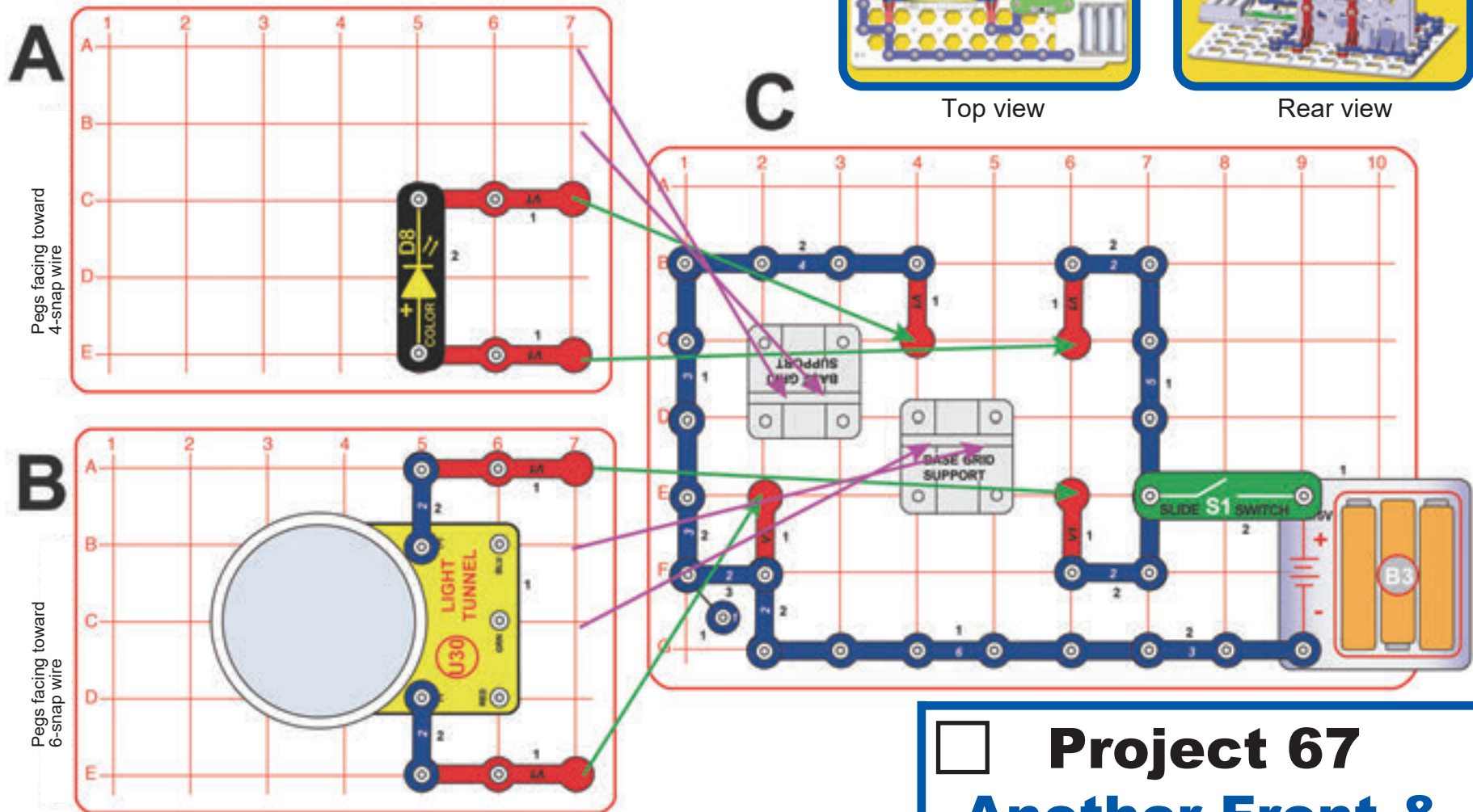

- Assembly:
1. Place base grid supports on base grid C.
 2. Place parts on grids A&B, and install into base grid supports on grid C. Pegs on grid A should face toward the 4-snap wire (which on grid C), while the pegs on grid B should face toward the 6-snap wire, so that grids A&B are facing in opposite directions.
 3. Install remaining parts on grid C.
- Turn on the slide switch (S1). The color LED (D8) shines in one direction, and the light tunnel (U30) shines in the opposite direction.

Project 67

Another Front & Back Circuit

Use the preceding circuit but replace either the color LED (D8) or light tunnel (U30) with the white LED (D6). You may add the projector to the white LED if desired.

Project 68

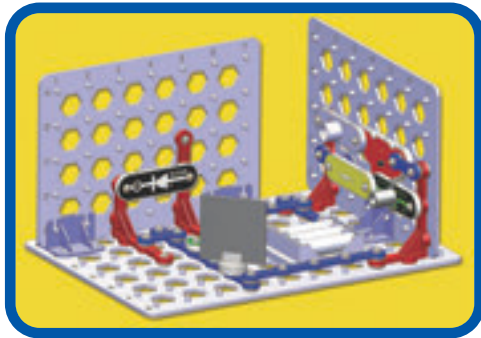

Break the Reflection Beam

Assembly:

1. Place base grid supports on base grid A.
2. Place parts on grids B&C, and install into base grid supports on grid A.
3. Install remaining parts on grid A.
4. Add the Q4 attachment and mirror.

Turn on the slide switch (S1); and align the mirror so that light from the white LED (D6) is reflected to shine directly on the phototransistor (Q4), to shut off the alarm. Now place your hand to block the reflected beam and turn on the alarm.

Note: If too much room light shines on the phototransistor then the alarm may never activate (because the circuit doesn't notice that the beam was broken), so try dimming the room lights or repositioning the circuit.

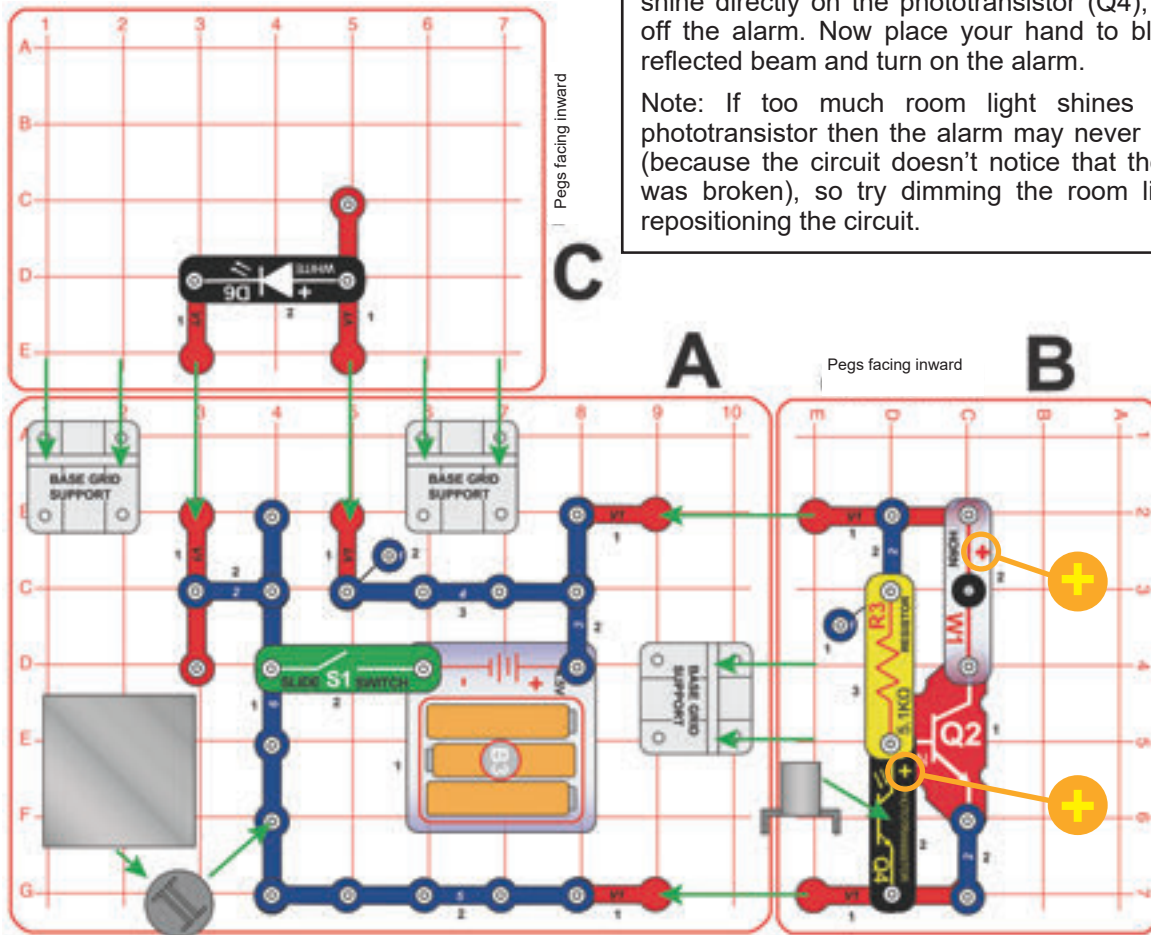

Project 69

Bouncy Reflection Beam

Modify the lower-left of the preceding circuit to mount the mirror on a spring, as shown. Turn on the slide switch (S1), and align the mirror so that light from the white LED (D6) is reflected to shine directly on the phototransistor (Q4), to shut off the alarm. Now push the mirror so that the spring bounces it back and forth, turning the alarm on and off as it bounces.

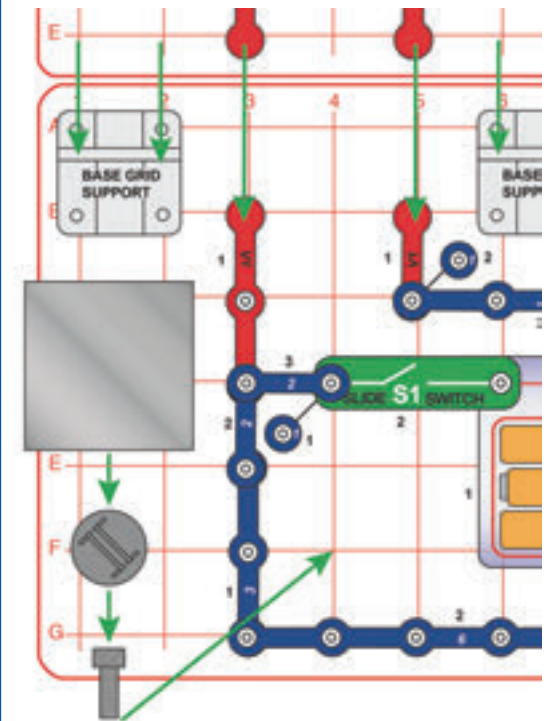



Project 70

Break the 2-Reflection Beam

If too much room light shines on the phototransistor then the alarm may never activate (because the circuit doesn't notice that the beam was broken), but having some room light may make it easier to align the mirrors (because less light is needed from the white LED).

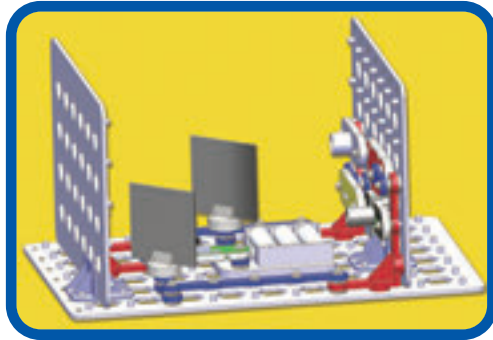

Assembly:

1. Place base grid supports on base grid A.
2. Place parts on grids B&C, and install into base grid supports on grid A.
3. Install remaining parts on grid A.
4. Add the Q4 attachment and mirrors.

Turn on the slide switch (S1); and carefully align the two mirrors so that light from the white LED (D6) is reflected to shine directly on the phototransistor (Q4), to shut off the alarm. Now place your hand to block the reflected beam and turn on the alarm.

Note: The mirrors must be precisely aligned for this to work. To help with this alignment, do this in a dimly lit room, watch where the reflected light is shining, and try to get it centered on Q4. Depending on the brightness of your room lights, you may get better results without using the Q4 attachment, or by having brighter room lighting.

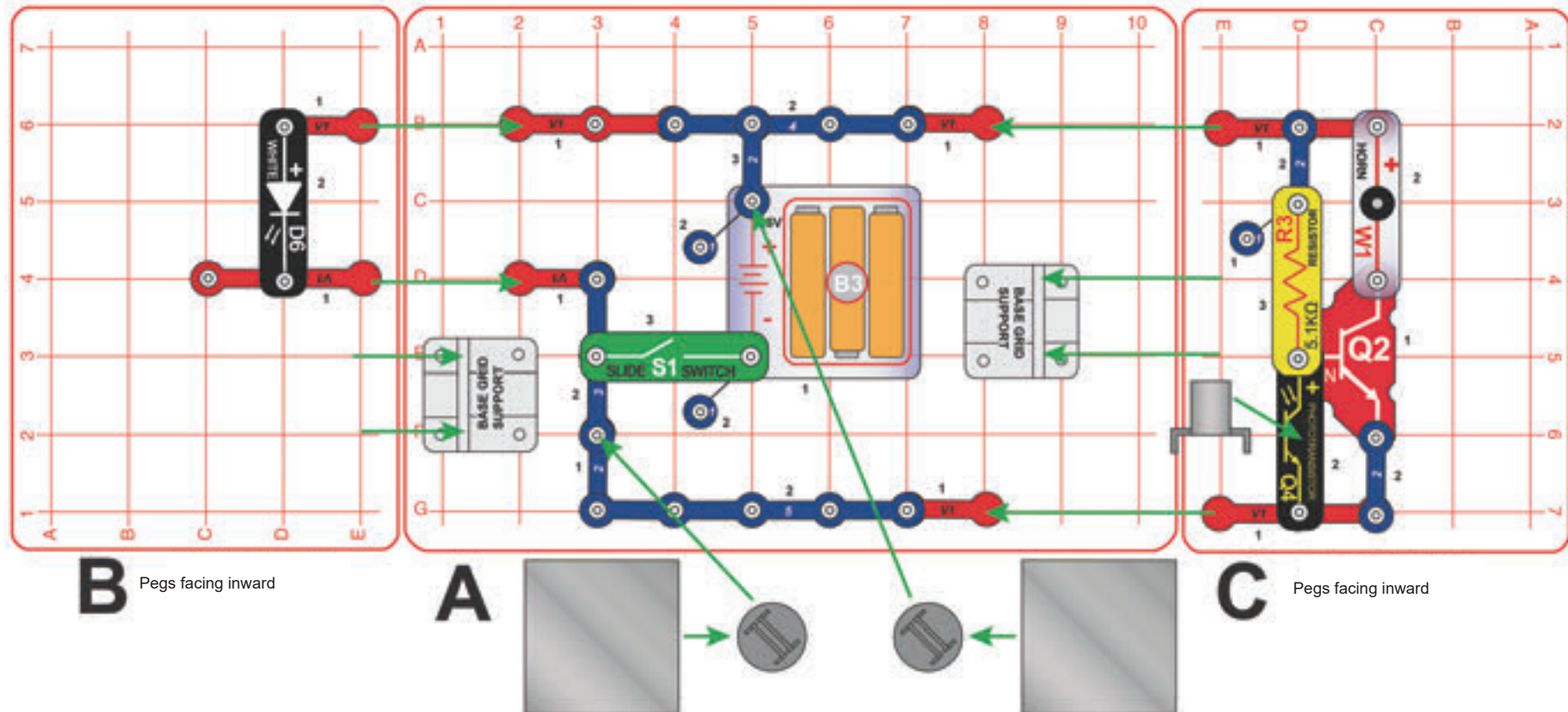



Project 71

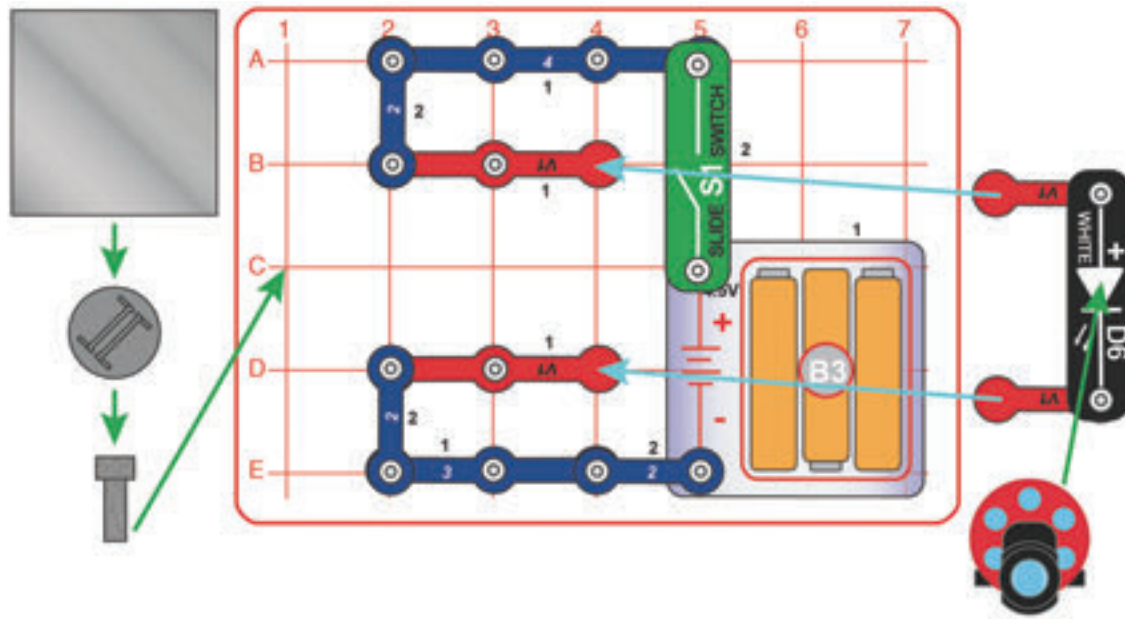

Bouncy Blur

Use two vertical snap wires (V1) and mount the white LED (D6) on them so it will shine towards a wall, then place the projector on the white LED. Mount the mirror and its base on a spring, and orient the mirror so the reflected image will shine towards a wall. Turn on the slide switch (S1) and adjust the knob on the projector to show an image on the wall. Give the mirror a push so it bounces back and forth on the spring, making the image bounce around on the wall. The room should be very dark for best effects.



Project 72

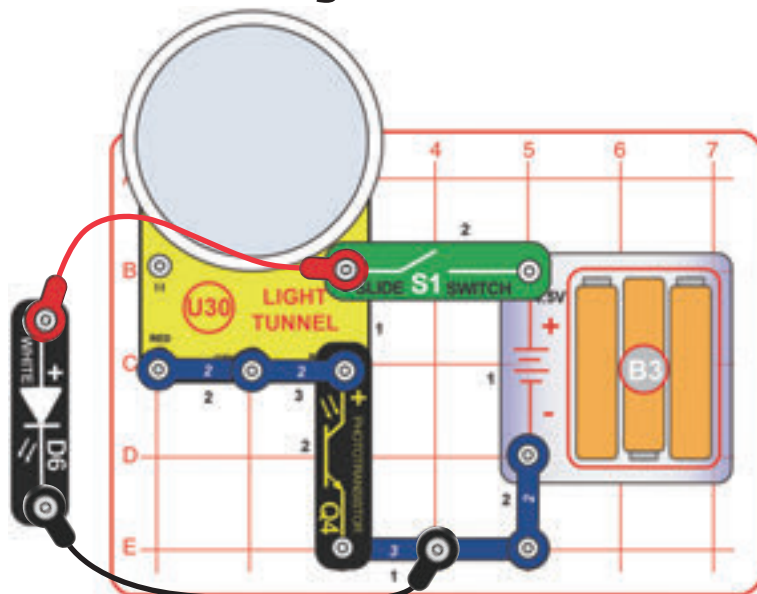

Light-Controlled Light Tunnel

Turn on the slide switch (S1) and vary the amount of room light shining on the phototransistor (Q4). If the light on the phototransistor is bright enough then some of the LEDs in the light tunnel (U30) may be on. Now hold the white LED (D6) so it shines on the phototransistor. If you hold D6 directly above Q4 and touch it then all the lights in the light tunnel should be on.

The phototransistor uses light to control electric current. There are a lot of LEDs in the light tunnel, so the phototransistor needs very bright light on it to let through enough current through to light up the light tunnel.





Project 73

2-Front Circuit

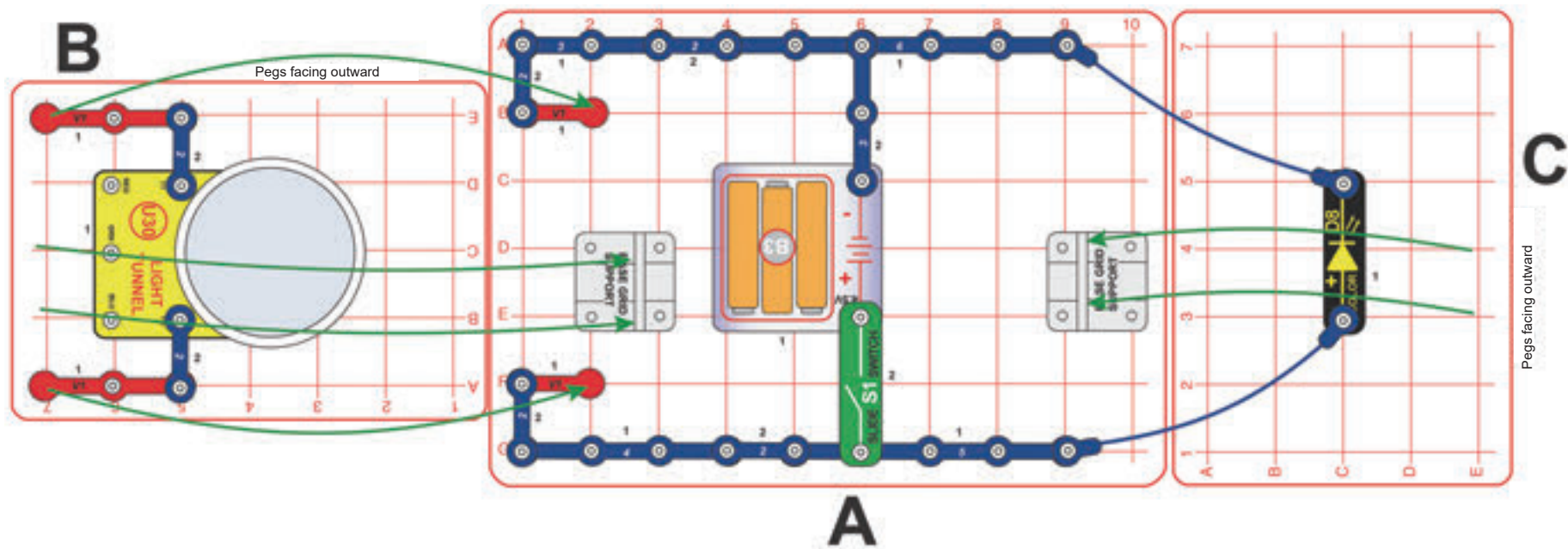

Assembly:

1. Place base grid supports on base grid A.
2. Place parts on grids B&C, and install into base grid supports on grid A. Pegs on grids B&C should be facing outward.
3. Install remaining parts on grid A.
4. Add the two blue jumper wires. Since they are short, be sure to put them through the holes in grid C, as shown in the picture on the right.

Turn on the slide switch (S1) to see light displays on the light tunnel (U30) and the color LED (D8).

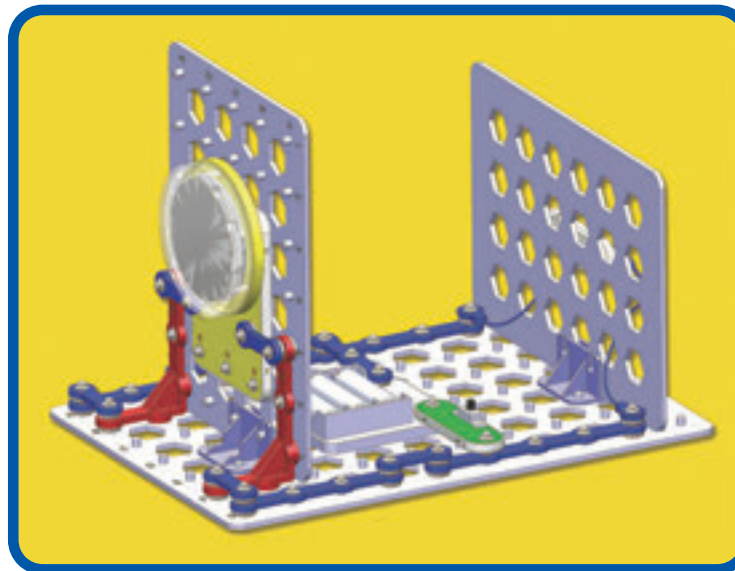

Project 74

Another 2-Front Circuit

Use the preceding circuit but replace either the color LED (D8) or light tunnel (U30) with the white LED (D6). You may add the projector to the white LED if desired.

Project 75 Series of LEDs

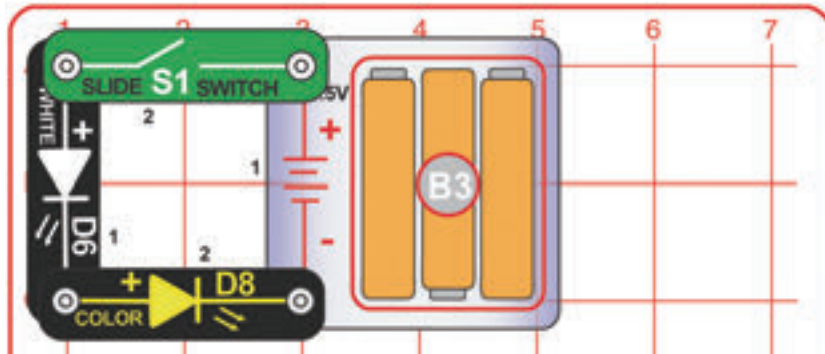

Build the circuit and turn on the slide switch (S1). The white and color LEDs (D6 & D8) should be blinking but may be dim. If neither lights at all then replace your batteries.

This circuit has both LEDs connected in SERIES. Series circuits are simple to connect, and allow one component to easily control another (here the white LED blinking is controlled by the color LED's blinking). The LEDs may be dim because the battery voltage may not be high enough to make both bright. If one LED breaks, then the circuit is broken and neither will work.

The slide switch (S1) is also connected in series with the LEDs, so it can turn them on and off.



Project 76 Horn & Color Light

Use the preceding circuit but replace the white LED (D6) with the horn (W1, "+" side towards S1). The color LED lights but may not be blinking, and the horn may not be very loud. (Electrical noise generated by the horn can disrupt the color-changing circuitry in the color LED.)

Project 77 Horn & White Light

Use the preceding circuit but replace the color LED (D8) with the white LED (D6).

Project 78 Parallel LEDs

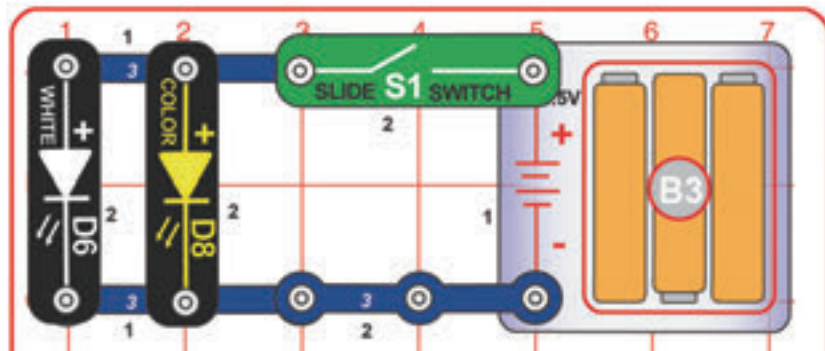

Build the circuit and turn on the slide switch (S1). The white and color LEDs (D6 & D8) are bright now and only the color LED is blinking.

Compare this circuit to the project 75 circuit. This circuit has both LEDs connected in PARALLEL. Parallel circuits make components independent of each other but require more complex wiring (notice how this circuit requires more parts than the project 75 circuit). Both LEDs are bright because each gets the full battery voltage, but they will drain the batteries faster. If one LED breaks then the other will still work.



Project 79 Horn & Color Light (II)

Use the preceding circuit but replace the white LED (D6) with the horn (W1). The color LED is bright and blinking, and the horn is loud. Compare this circuit's performance to project 76.

Project 80 Horn & White Light (II)

Use the preceding circuit but replace the color LED (D8) with the white LED (D6). Compare this circuit's performance to project 77; the white LED is brighter, and the horn is louder.



Project 81

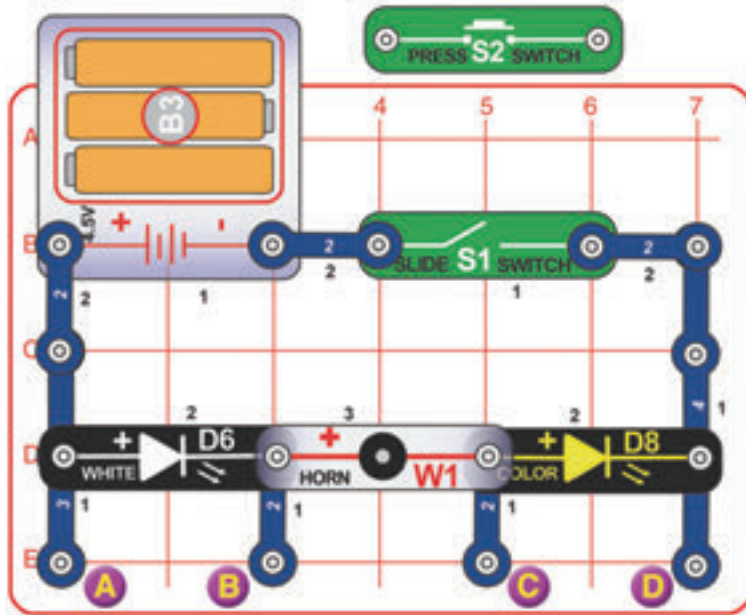

Triple Series?

Build the circuit as shown, leaving the press switch (S2) out of the circuit for now. Turn on the slide switch (S1); most likely nothing will happen. Now add the press switch between the points labeled A&B, B&C, or C&D, and push it. Try it at all 3 locations.

Most likely the battery voltage (4.5V) will not be strong enough to turn on any of the LEDs (D6 & D8) or the horn (W1) when all are connected together in series. Adding the press switch (S2) bypasses one of them, and should allow the remaining ones to operate, though probably not at their best.



Project 82

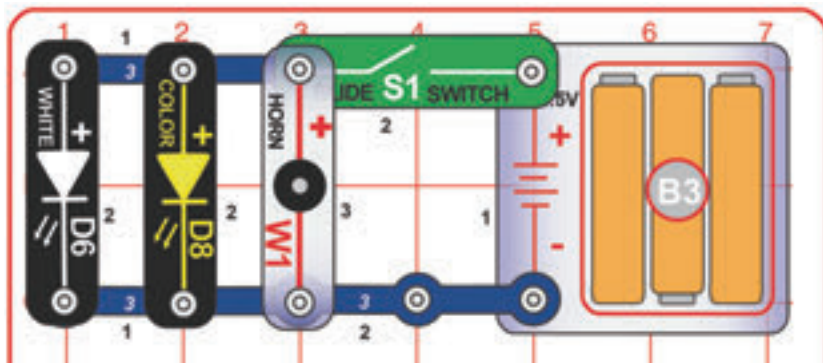

Triple Parallel

Build the circuit and turn on the slide switch (S1). The white and color LEDs (D6 & D8) are bright, and the horn (W1) is loud.

Both LEDs and the horn are all connected in parallel, and have enough voltage to perform at their best. Compare this circuit to projects 75-80.



Project 83 Four Fun

Turn on the slide switch (S1). The horn (W1) sounds, the white LED (D6) is very bright, the color LED (D8) is changing colors, and the light tunnel (U30) lights up with red, green, and blue LEDs. For best effects, dim the room lights.

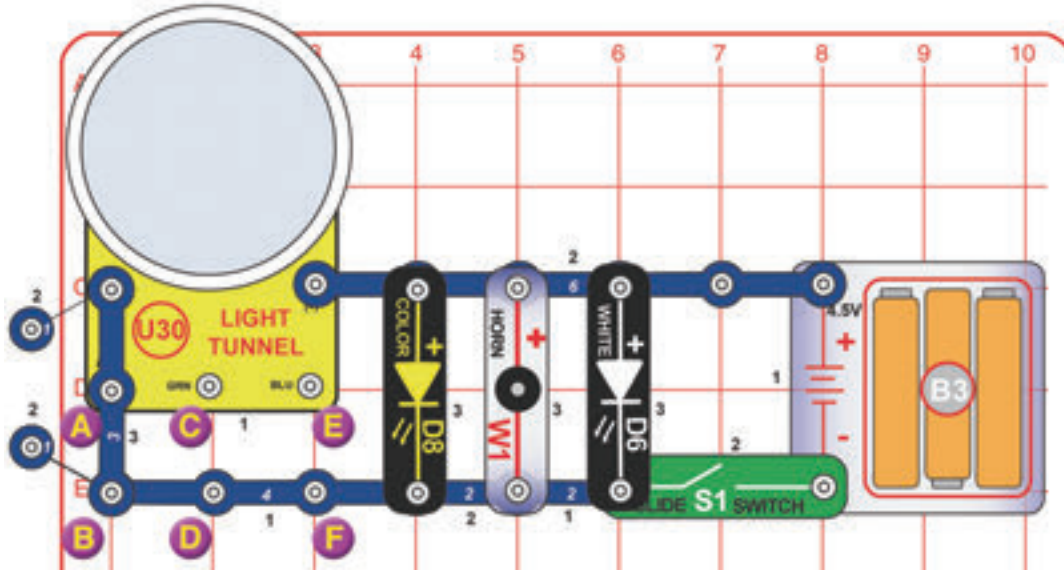

Project 84 4 - 1 = 3 Fun

Use the preceding circuit but remove the horn (W1), because some people may think it is loud and annoying.

Project 86 Four Fun Green

Use the project 83-84 circuits but remove the 1- snap and 3-snap wires from the left of the circuit, and connect a 2-snap wire across points C & D.

Project 85 Four Fun Red

Use the project 83-84 circuits but remove the 1- snap and 3-snap wires from the left of the circuit, and connect a 2-snap wire across points A & B.

Project 87 Four Fun Blue

Use the project 83-84 circuits but remove the 1- snap and 3-snap wires from the left of the circuit, and connect a 2-snap wire across points E & F.

Project 88 Four Fun Red & Green

Use the project 83-84 circuits but remove the 1-snap and 3-snap wires from the left of the circuit, and connect 2-snap wires across points A & B and C & D.

Project 89 Four Fun Red & Blue

Use the project 83-84 circuits but remove the 1-snap and 3-snap wires from the left of the circuit, and connect 2-snap wires across points A & B and E & F.

Project 90 Four Fun Green & Blue

Use the project 83-84 circuits but remove the 1-snap and 3-snap wires from the left of the circuit, and connect 2-snap wires across points C & D and E & F.

Project 91 Vertical Four Fun

Use the project 83-90 circuits but mount it vertical over one of the mini base grids using two base grid supports, as shown here.

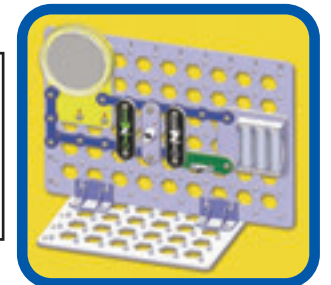

Project 92

Lights & Mirrors

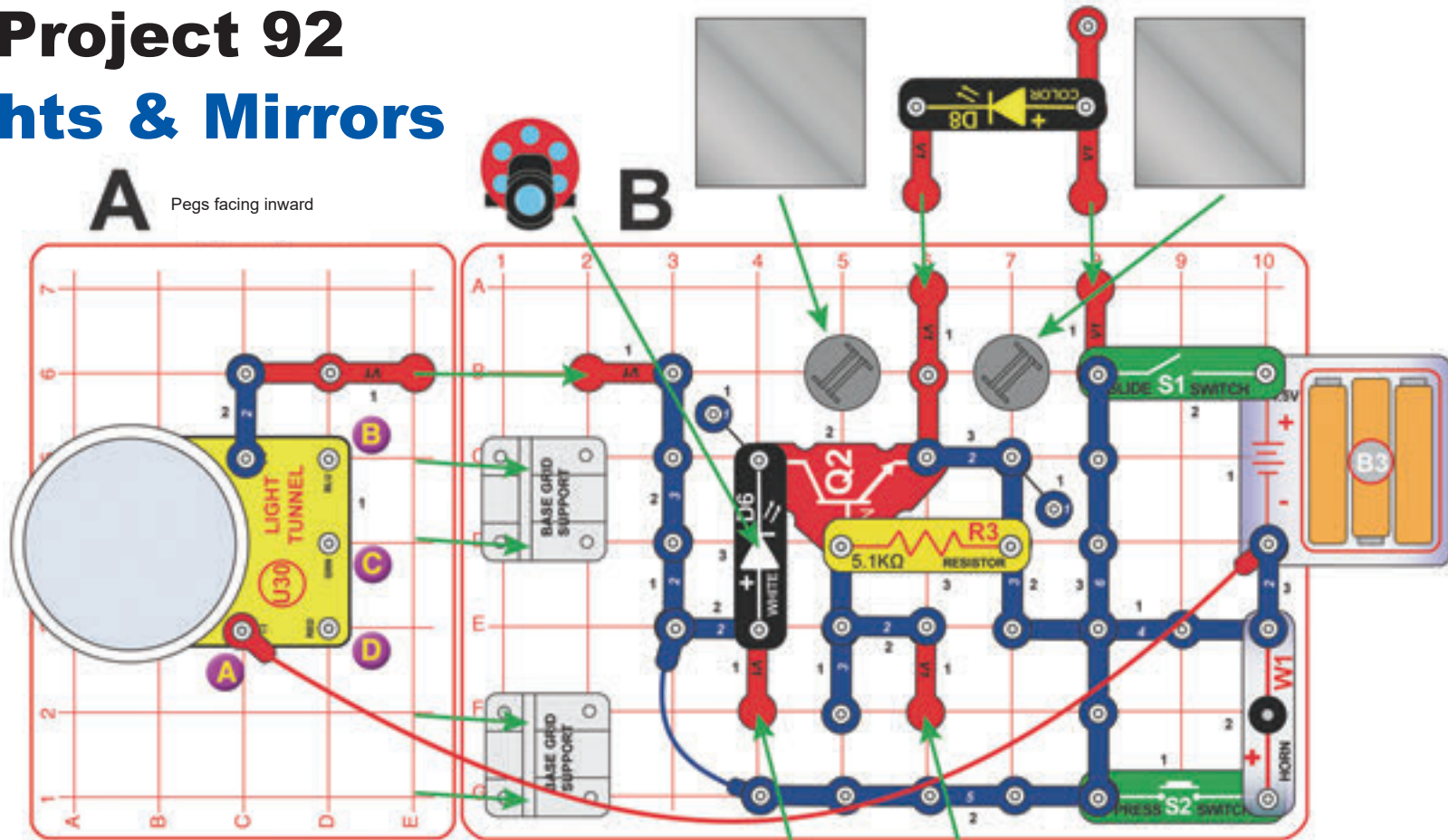

Assembly:

1. Place base grid supports on base grid B.
2. Place parts on grid A (except the red jumper wire), and install into base grid supports on grid B.
3. Install remaining parts on grid B, including the blue and red jumper wires.
4. Add the Q4 attachment, projector, and mirrors.

Turn on the slide switch (S1); and carefully align the two mirrors so that light from the color LED (D8) is reflected to shine directly on the phototransistor (Q4), the white LED (D6) is blinking when you succeed (to make this easier, leave the projector off the white LED when aligning the mirrors). Now placing your hand to block the reflected beam turns off the white LED. Adjust the knob on the projector to select an image to be projected on the ceiling. Push the press switch (S2) to make noise. The projector and LED effects look best in a dimly lit room.

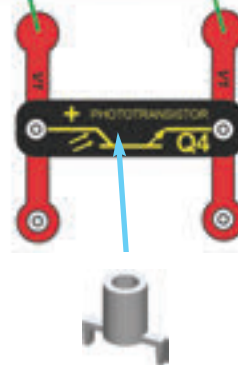

Project 93

Noisy Lights & Mirrors

Use the project 92 circuit but swap the locations of the white LED (D6) and the horn (W1). Now the horn sounds when you have the mirrors aligned.

Project 94

Lights & Blinkless Mirrors

Use the project 92-93 circuits but swap the locations of the color LED (D8) and white LED (D6). You may place the projector on D8, or leave it out.

Project 95

Red Lights & Mirrors

Use the projects 92-93 circuits but move the end of the red jumper wire from point A to point D on the light tunnel (U30).

Project 96

Green Lights & Mirrors

Use the projects 92-93 circuits but move the end of the red jumper wire from point A to point C on the light tunnel (U30).

Project 97

Blue Lights & Mirrors

Use the projects 92-93 circuits but move the end of the red jumper wire from point A to point B on the light tunnel (U30).

Project 98 Transistor Control

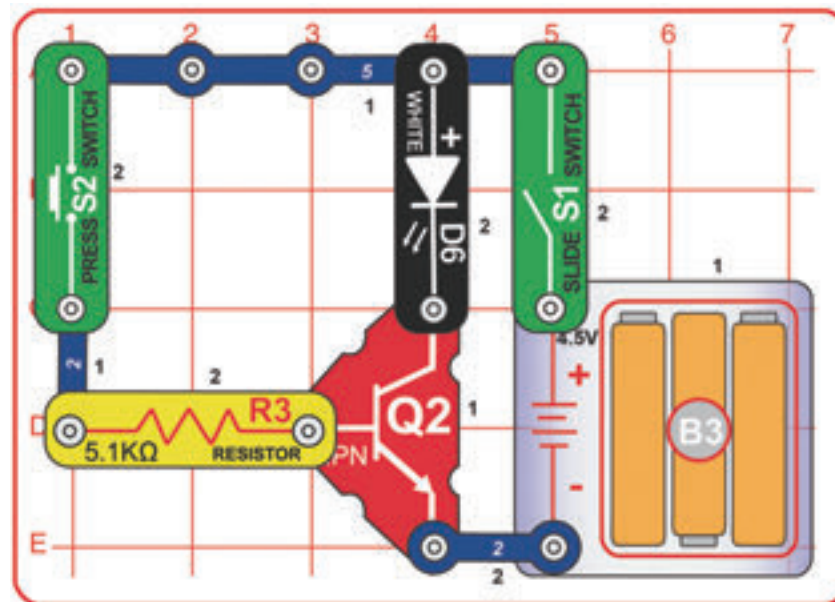

Turn on the slide switch (S1); nothing happens. Now push the press switch (S2); the white LED (D6) lights. You can replace the white LED with the color LED (D8) or the horn (W1).

Electric current flows into the NPN transistor (Q2) from the left (with R3) and the top (D6), then all exits through the bottom (with the 2-snap). The current into the left side controls the current into the top side, so D6 is only on when S2 is pressed.





Project 99

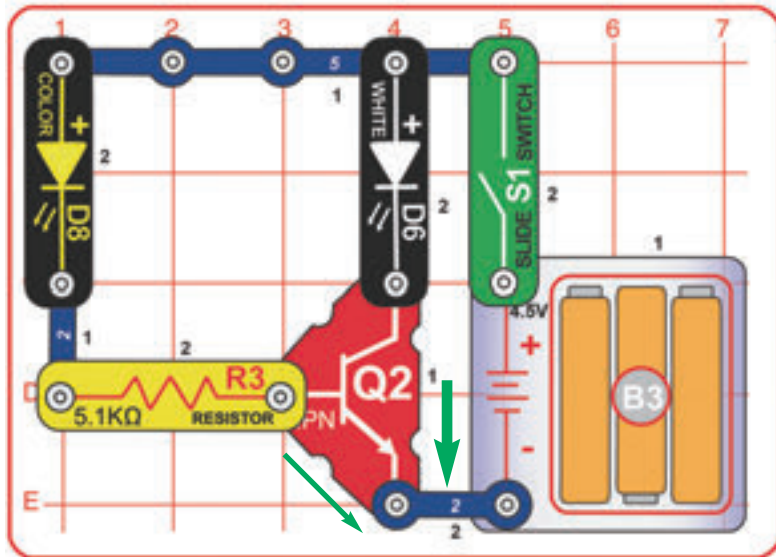

Transistor Amplifier

Turn on the slide switch (S1). The color LED (D8) is dim but the white LED (D6) is bright. Remove either LED (D6 or D8) and see what happens to the other one.

The NPN transistor (Q2) is a current amplifier. When a small current flows into Q2 through the left branch (through D8), a larger current will flow into Q2 through the right branch (with D6). Green arrows shown the. So the LED on the right side will be brighter than the LED on the left side. The current in the right branch might be 100 times larger than in the left branch.

The left branch controls the right branch, so removing D8 turns off D6, but removing D6 does not affect D8.



Project 100 Another Transistor Amplifier

Use the preceding circuit, but swap the locations of the white LED (D6) and the color LED (D8).



Project 101 Transistor Amplifier w/ Horn

Use either of the two preceding circuits, but replace either of the LEDs (D6 or D8) with the horn (W1).

Notice how the horn makes little or no sound when placed in the left branch (because the 5.1kΩ resistor is in series with it), but you know that a small current is flowing through it because the LED in the right branch is on.



Project 102 Alternating Lights Sound

Turn on the slide switch (S1). The color LED (D8) is blinking, the white LED (D6) is on whenever the color LED is off, and the horn (W1) is making lots of noise.

When the color LED is off, the NPN transistor (Q2) is off (and does not affect the circuit), so electricity just flows through the horn and white LED. When the color LED is on, the transistor is on and all the electricity flowing through the horn also flows through the transistor, bypassing the white LED (turning it off).

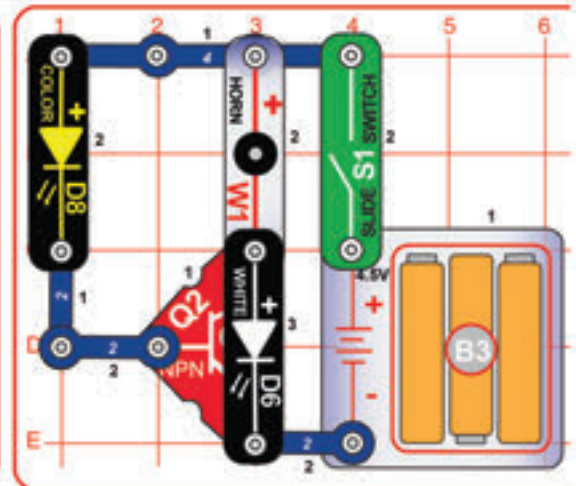

Project 103

Photo Control

Project 104

Photo Control (II)

Use the preceding circuit, but replace the white LED (D6) with the color LED (D8).

Project 105

Photo Control (III)

Use the preceding circuit, but replace the horn (W1) with the white LED (D6).

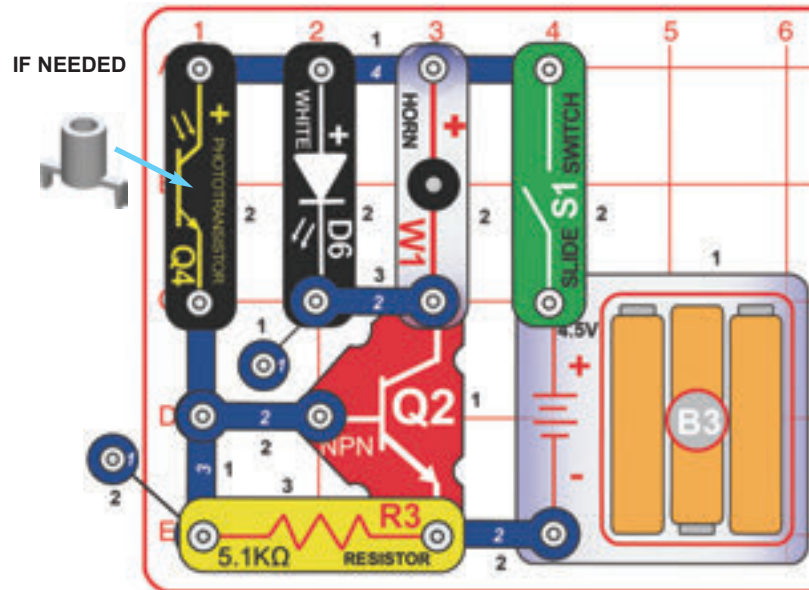

Build the circuit and turn on the switch (S1). The white LED (D6) and horn (W1) will be on if there is light on the phototransistor (Q4); cover the phototransistor to turn them off. If the LED and horn turn on too easily then place the Q4 attachment on Q4 to restrict the light to it.

The phototransistor is able to control other devices (such as the white LED and horn) much more easily than in projects 54- 55, because the NPN transistor (Q2) is used as an amplifier. The NPN transistor helps a small electric current through the phototransistor control a larger electric current through the LED and horn.



Project 106

Photo Control (IV)

Use the project 103-105 circuits but remove the 5.1kΩ resistor, and see how its sensitivity to light changes.

The 5.1kΩ resistor diverts some current from the phototransistor to keep the circuit from being too sensitive to light.



Project 107

High Sensitivity Photo Control

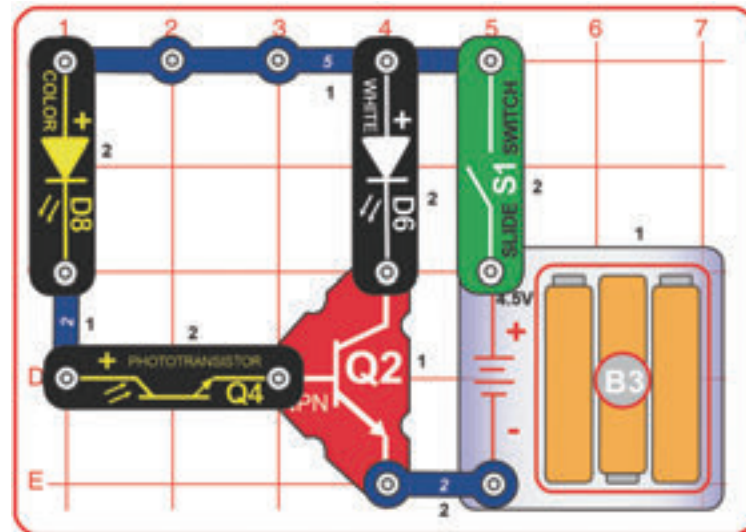

Build the circuit and turn on the switch (S1). Vary the amount of light shining on the phototransistor (Q4) to see how easily the brightness of the color LED (D8) and white LED (D6) can be adjusted. Notice that D6 may remain bright even when D8 is off. You may have to completely cover Q4 with your hand and/or take the circuit into a really dark room to get D6 off. If desired, place the Q4 attachment on Q4 to restrict the light to it. You can also swap the locations of the LEDs (D6 & D8).

A small electric current may be flowing through the color LED even though it appears to be off. This small current, amplified by the NPN transistor (Q2) can be enough to keep the white LED on.

Project 108

Reverse Photo Control

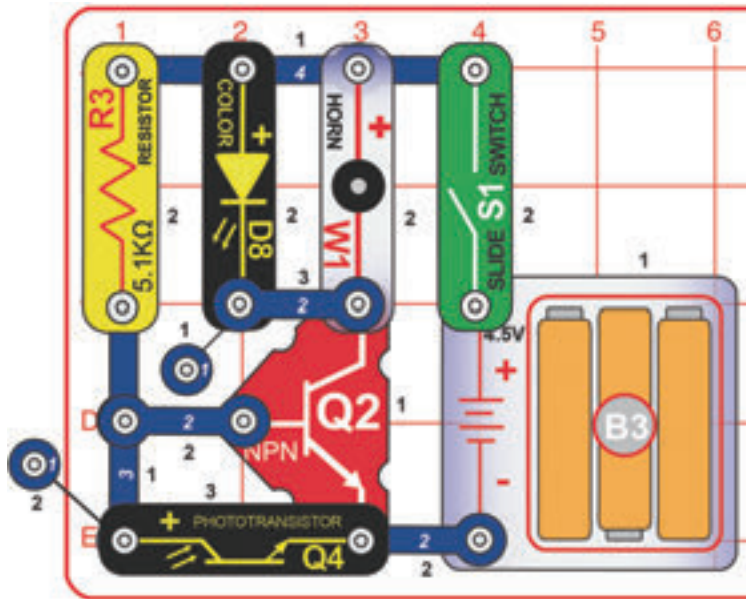

Build the circuit and turn on the switch (S1). The color LED (D8) and horn (W1) will be on unless there is bright light on the phototransistor (Q4); cover the phototransistor if the LED and horn are on, or shine brighter light on it if they are off.

Projects 108-110 are the inverse of projects 103-105. If you remove the phototransistor from the circuit then the LED and horn will always be on, because then the circuit is controlled by the 5.1kΩ resistor, and it does not change.



Project 109 Reverse Photo Control (II)

Use the preceding circuit, but replace the color LED (D8) with the white LED (D6).

Project 110 Reverse Photo Control (III)

Use the preceding circuit, but replace the horn (W1) with the color LED (D8).

Project 111 Infrared-Controlled Light

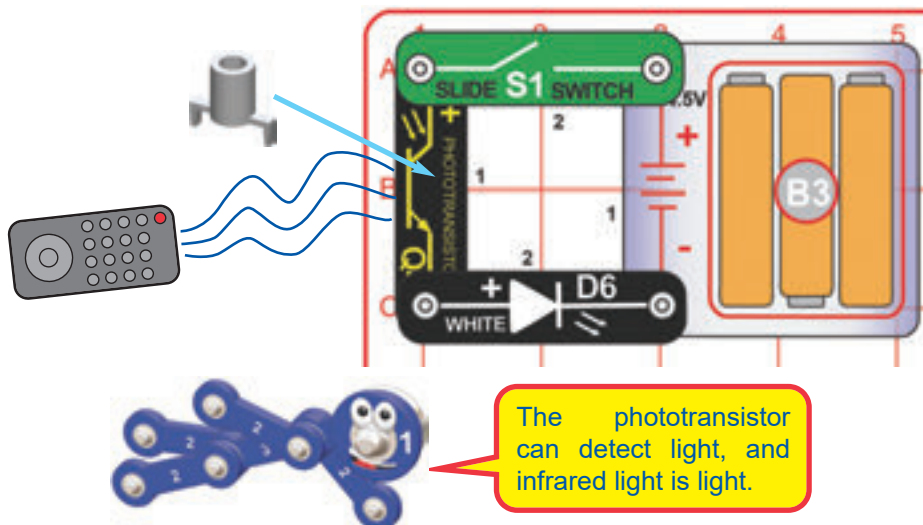

The phototransistor can detect light, and infrared light is light.

You need an infrared remote control for this project, such as any TV/stereo/DVD remote control in your home.

Build the circuit and turn on the switch (S1). Place the Q4 attachment on the phototransistor (Q4). Position the circuit away from lights in the room so that the white LED (D6) is off. Point your remote control directly into the Q4 attachment, and press any button to turn on the white LED. The LED may not get very bright.

Project 112

Infrared-Controlled Color Light

Replace the white LED (D6) with the color LED (D8).



Project 113

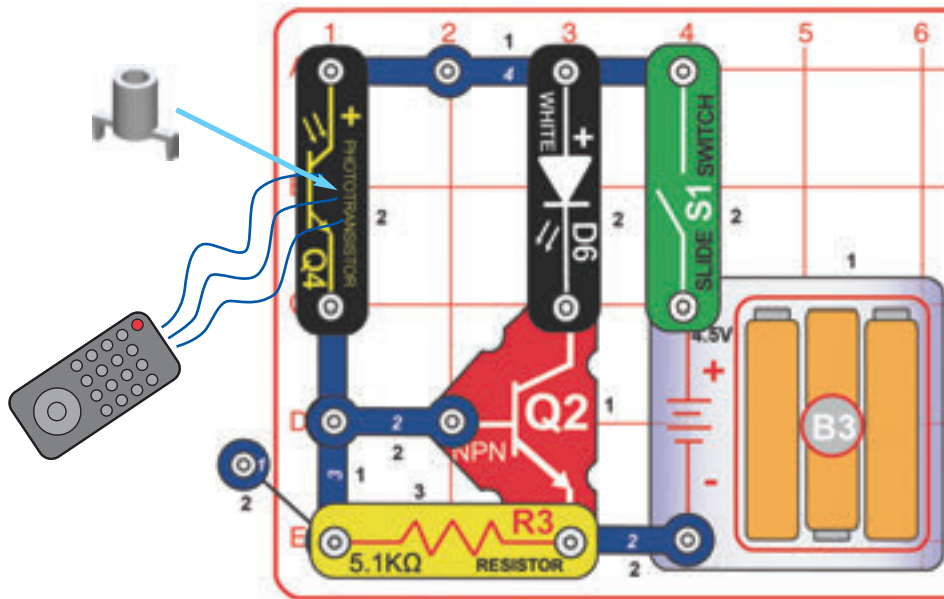

IR Control

You need an infrared remote control for this project, such as any TV/ stereo/DVD remote control in your home.

Turn on the slide switch (S1) and place the Q4 attachment on the phototransistor (Q4). Position the circuit away from lights in the room so that the white LED (D6) is off. Point your remote control directly into the Q4 attachment, and press any button to turn on the white LED.

Note that when the phototransistor (Q4) is activated by room lights the white LED is on continuously, and when the phototransistor is activated by your infrared remote control LED will be blinking.

The phototransistor can detect light, and infrared light is light. The white LED is blinking even if you are pressing your remote control continuously, because the signal from your remote control is not constant, but rather a stream of infrared light bursts.



Project 114 Color IR Control

Use the preceding circuit, but replace the white LED (D6) with the color LED (D8). The circuit works the same way, but note that when the phototransistor (Q4) is activated by room lights the color LED will execute a blinking pattern, and when the phototransistor is activated by your infrared remote control the color LED will be on but its normal pattern will be blurred.

The color LED needs a constant voltage to operate its color-changing pattern properly. The infrared control signal is a stream of infrared light bursts, which disrupt the LED's color-changing circuitry.



Project 115 Audio IR Control

Use the preceding circuit, but replace the color LED (D8) with the horn (W1). The circuit works the same way, but note that when the phototransistor (Q4) is activated by room lights the horn makes a loud continuous sound, and when the phototransistor is activated by your infrared remote control the horn will be on but only make a low buzzing sound.

Similarly, the horn needs a constant voltage to operate properly, and the buzzing sound you hear is because the infrared control signal is not stable enough to operate the horn properly.



Project 116 Photo Control Four

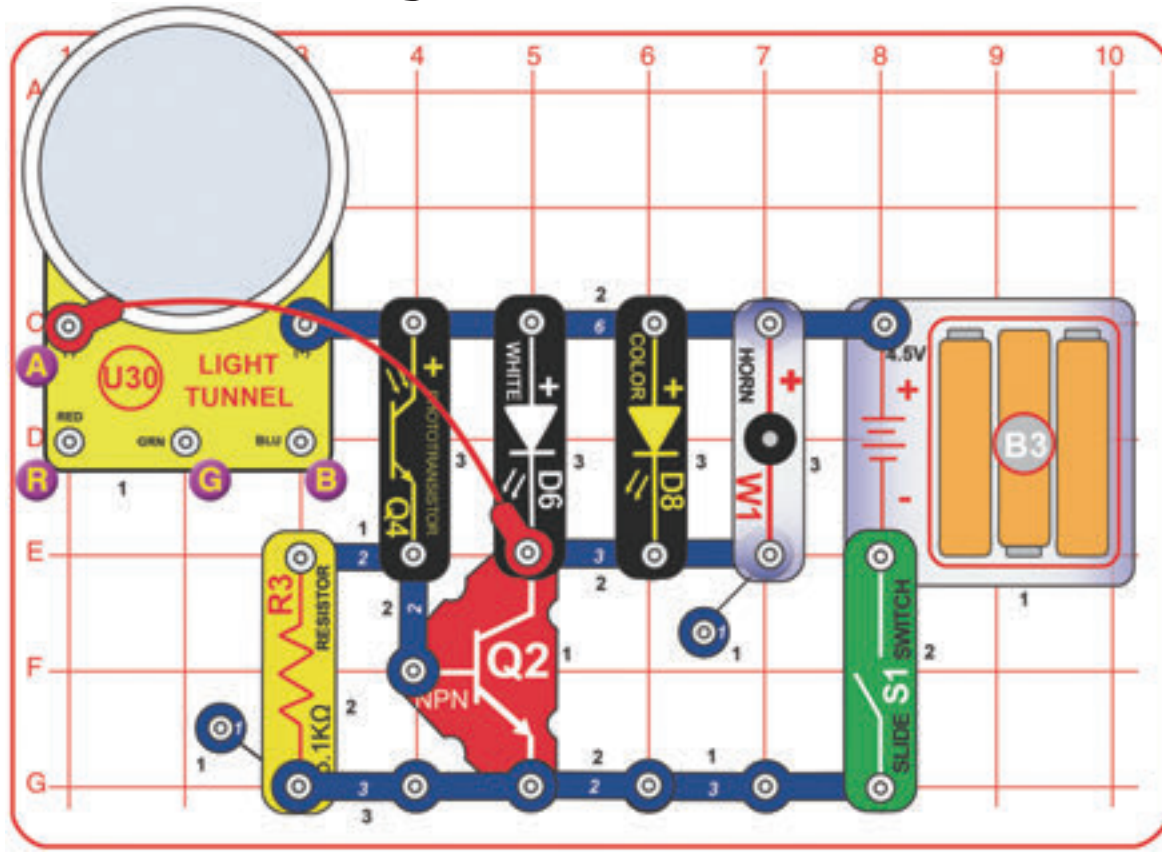

Build the circuit and turn on the switch (S1). Four devices should be on (light tunnel (U30), white LED (D6), color LED (D8), and horn (W1)); cover the phototransistor (Q4) to shut them off. If none of the devices are on then shine more light on the phototransistor. You can place the Q4 attachment on Q4 if you want to make it less sensitive to light. Remove the horn if you find its sound too annoying. Variants:

1. Move the end of the red jumper wire from point A to points, R, G, or B.
2. Place a 2-snap across points R & G, or points G & B. Move the end of the red jumper wire from point A to the 2-snap.

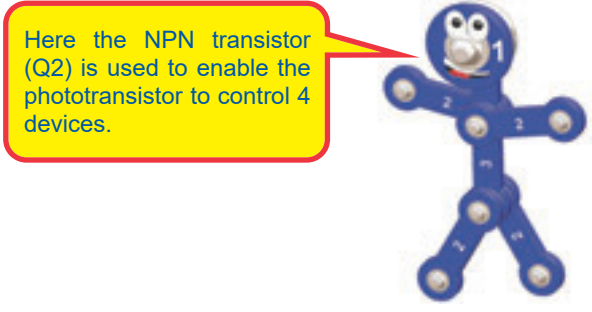

Here the NPN transistor (Q2) is used to enable the phototransistor to control 4 devices.

Project 117 Light Up the Night

Use the preceding circuit but swap the locations of the phototransistor (Q4) and 5.1kW resistor (R3), "+" on Q4 should be towards U30. Now the four devices (U30, D6, D8, and W1) will be on unless there is bright light on the phototransistor.

Project 118 Infrared Control Four

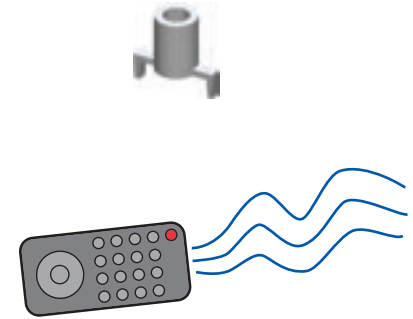

You need an infrared remote control for this project, such as any TV/stereo/DVD remote control in your home. Use the project 116 circuit but place the Q4 attachment on the phototransistor (Q4). Position the circuit away from lights in the room so that the four devices (U30, D6, D8, and W1) are off. Point your remote control directly into the Q4 attachment, and press any button to turn on the four devices. Note that when the phototransistor (Q4) is activated by room lights the four devices are on continuously, and when the phototransistor is activated by your infrared remote control the light tunnel and LEDs will be blinking and the sound will be erratic.



Project 119

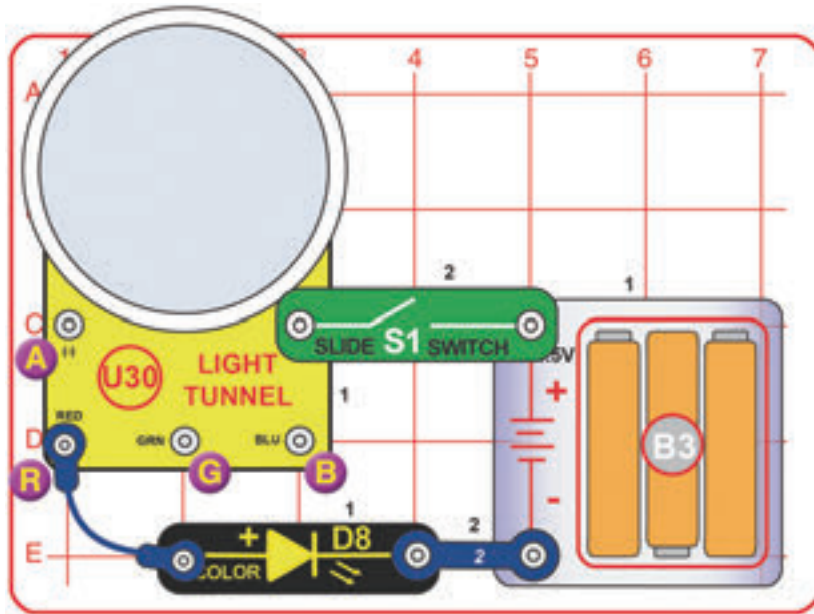

Double Blinker

Turn on the slide switch (S1). The red LEDs in the light tunnel (U30) are dim and blinking, and are in sync with the color LED (D8). For best effects, dim the room lights and use new batteries.

The color LED is connected in series with the light tunnel, making its color-changing circuitry control both. The three red LEDs in the light tunnel are connected in parallel with each other, so each only gets a third of the current, making them much dimmer than the color LED.



Project 120

Green Double Blinker

Use the preceding circuit, but move the end of the blue jumper wire from point R to point G. The LEDs may be a little dimmer now.

Green LEDs take more electrical energy to turn on than red ones, so the LEDs may be a little dimmer now.



Project 121

GBlue Double Blinker

Use the preceding circuit, but move the end of the blue jumper wire from point G to point B. The LEDs may be a little dimmer now.

Blue LEDs take more electrical energy to turn on than red or green ones, so the LEDs may be a little dimmer now.



Project 122

Multi Double Blinker

Use the preceding circuit, but move the end of the blue jumper wire from point B to point A. Now the light tunnel LEDs are dimmer but are changing colors; you may need a dark room or new batteries to see them.

Here the LED brightness is further reduced by the colorchanging circuitry in the light tunnel.



Project 123

White Double Blinker

Use the project 119-122 circuits but replace the color LED (D8) with the white LED (D6). Now all the LEDs are dimmer, and in some cases may not light at all.

White LEDs take more electrical energy to turn on than red or green or blue ones, so the LEDs are even dimmer now.





Project 124

Alternating Lights

Turn on the slide switch (S1). The white LED (D6) lights dimly. Now push the press switch (S2) and hold it down. The white and color LEDs (D6 & D8) appear to be alternately flashing.

In this circuit electricity to the white and color LEDs is restricted by the 5.1kW resistor (R3). The color LED (D8) contains separate red, green, and blue LEDs, with a microcircuit controlling them. Red and green LEDs turn on more easily than white LEDs, so when the red or green lights in the color LED are on, all the electricity through the 5.1kW resistor flows through them, and the white LED is off. Blue & white LEDs have similar turn-on characteristics, so when the blue LED in the color LED is on, both it and the white LED light dimly as the electricity flowing through the 5.1kW resistor is divided between them. All the LEDs in the color LED shut off briefly when it changes colors; when this happens the white LED is on as all the electricity flowing through the 5.1kW resistor flows through it, as if the press switch was not pressed.

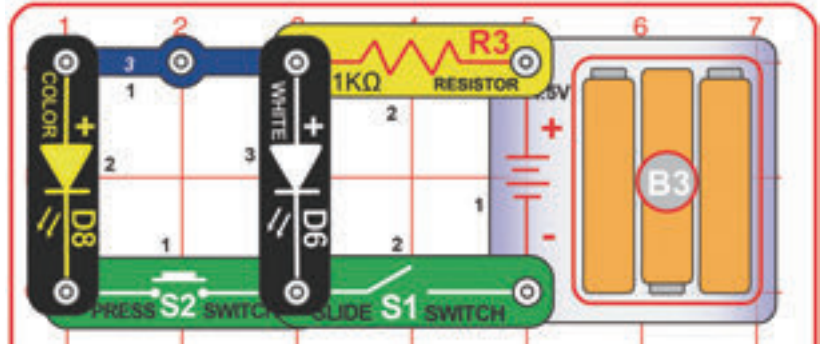

Project 125

Loud Multi-Color Sound

Turn on the slide switch (S1). The light tunnel (U30) is changing colors and sound from the horn (W1) is synchronized with it. The color LED (D8) is intentionally installed backwards and will not light.

The sound changes whenever the LEDs in the light tunnel turn off for a moment. The horn sound is louder here than in project 124 because the control current from the light tunnel is amplified by the NPN transistor (Q2) instead of controlling the horn directly.

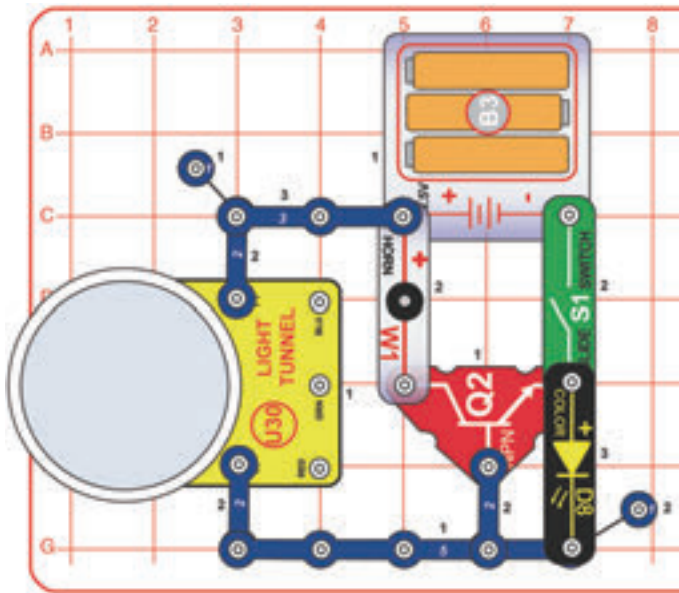

Project 126 Loud Multi-Multi-Color Sound

Use the preceding circuit but add the white LED (D6) on level 4 using one 1-snap wire, as shown. The white LED will light when the LEDs in the light tunnel turn off.

The sound changes whenever the LEDs in both the color LED and light tunnel turn off for a moment.

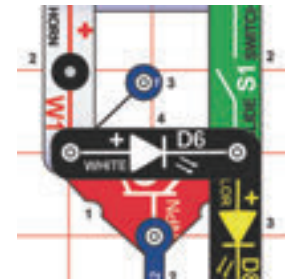



Project 127

Blue Blinking Fun

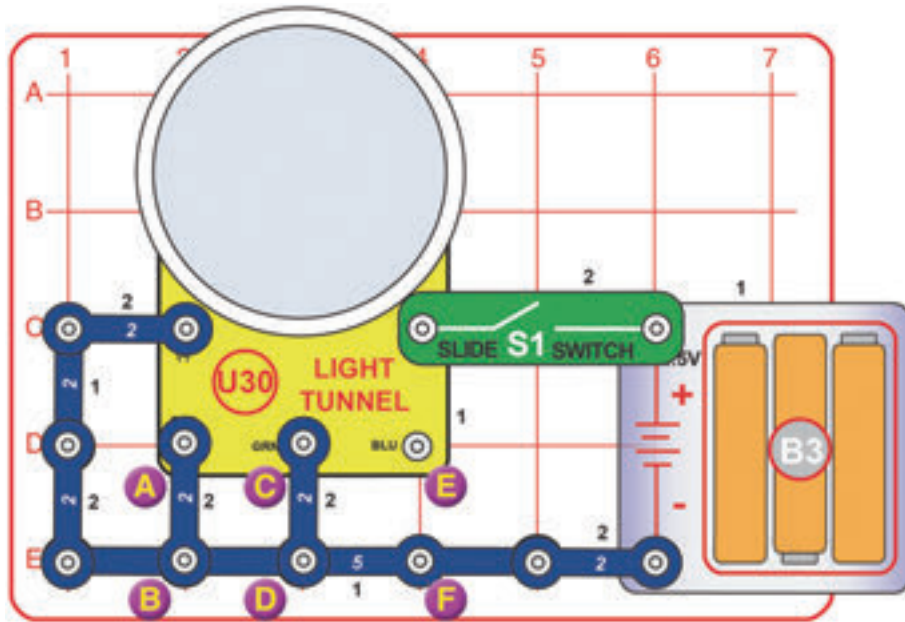

Turn on the slide switch (S1). The blue LEDs in the light tunnel (U30) are blinking, but the red & green ones are not.

The LEDs in the light tunnel can be controlled individually, or together in a preset changing pattern.



Project 128

Green Blinking Fun

Use the preceding circuit, but move the 2-snap wire from the points marked C & D to points E & F.

Project 129

Red Blinking Fun

Use the preceding circuit, but move the 2-snap wire from the points marked A & B to points C & D.

Project 130

Red-Green Blinking Fun

Use the preceding circuit, but remove the 2-snap wire from the points marked C & D.

Project 131

Red-Blue Blinking Fun

Use the preceding circuit, but move the 2-snap wire from the points marked E & F to points C & D.

Project 132

Green-Blue Blinking Fun

Use the preceding circuit, but move the 2-snap wire from the points marked C & D to points A & B.

Project 133

Button Ball



Mounted upside down:

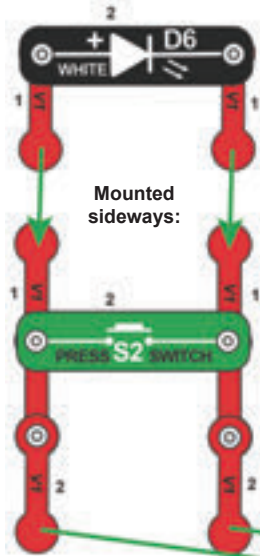

Mounted sideways:

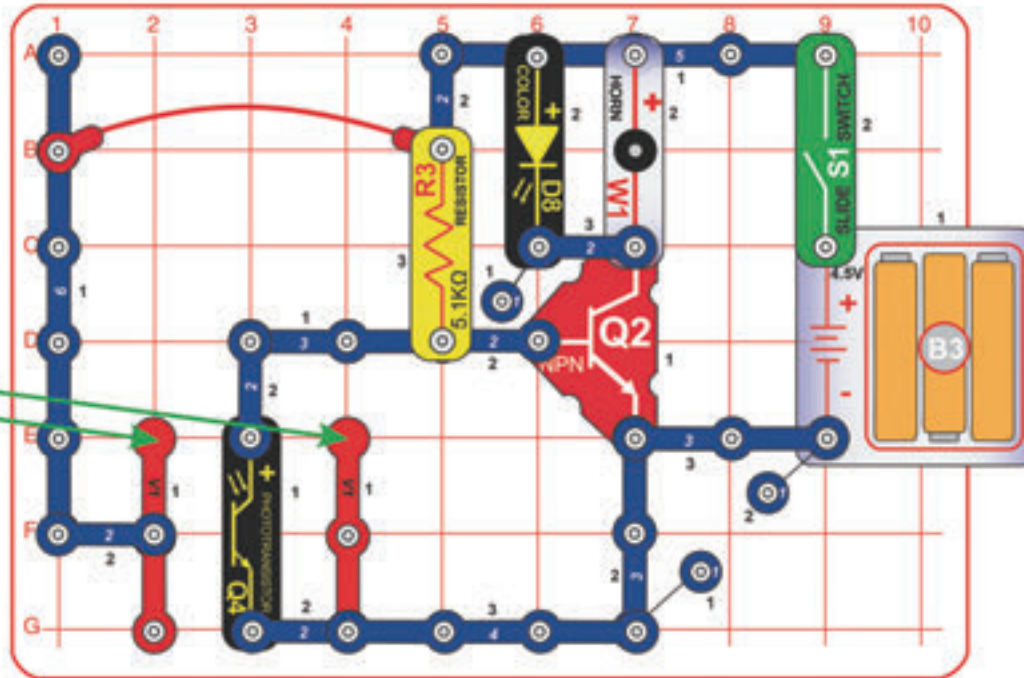

This project requires a ping pong ball or similar size ball (not included).

Assembly:

1. Place all parts on the base grid, including the two vertical snap wires (V1).
2. Mount the white LED (D6) and press switch (S2) on two other vertical snap wires, which are then mounted on the first ones, so that the white LED is upside down (so it will shine down onto the phototransistor (Q4)) and the press switch is sideways.

Turn on the slide switch (S1). The white LED should be on, but the color LED (D8) should be off and there should be no sound.

Facing the press switch, throw the ping pong ball to try to hit the button on the press switch, or get the ball through the opening under the press switch. The color LED (D8) lights and the horn (W1) sounds when you succeed (or come very close).

The press switch is used only to help stabilize the vertical snap wires, so do not press it.



Project 134 Hole Ball

Use the preceding circuit, but remove the press switch (S2) and lower the upper two vertical snap wires so the circuit looks as shown here. Try to throw the ping pong ball through the opening between the vertical snap wires.

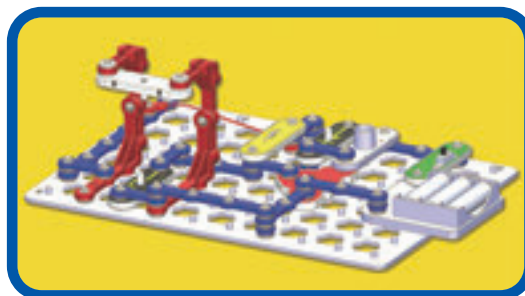

Mounted upside down:

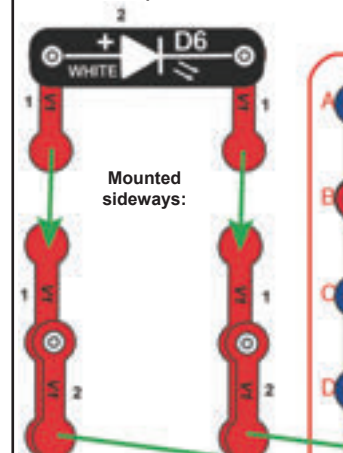

Mounted sideways:





Project 135

Hole Ball with Light Tunnel

Mounted upside down:

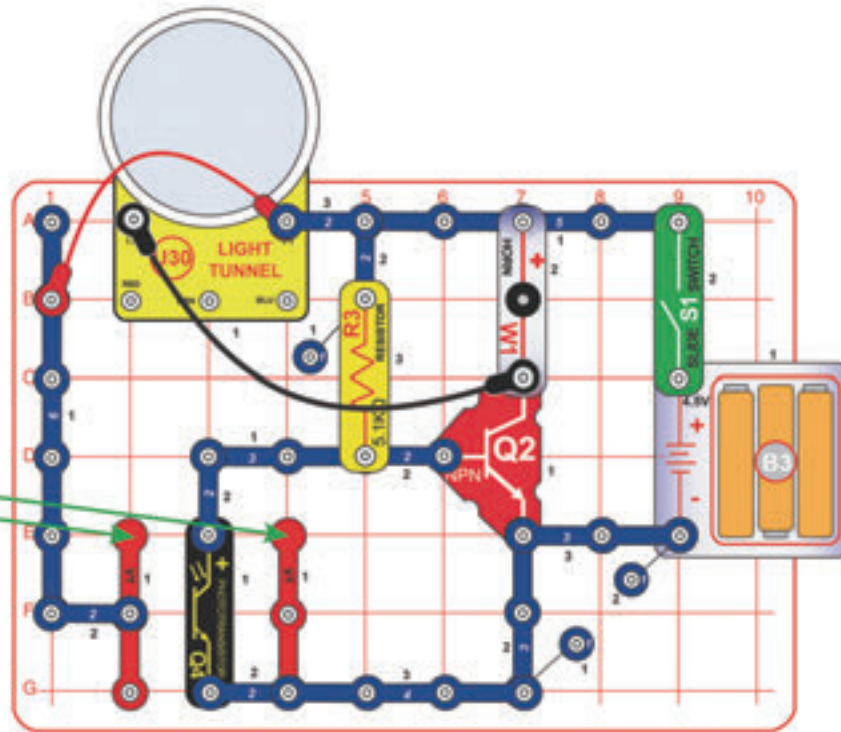
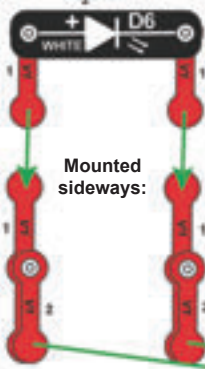

You can enhance the preceding circuit (and the one before it) by replacing the color LED (D8) with the light tunnel (U30), as shown. Try to throw the ping pong ball through the opening between the vertical snap wires.



Project 136

Check the Light Tunnel

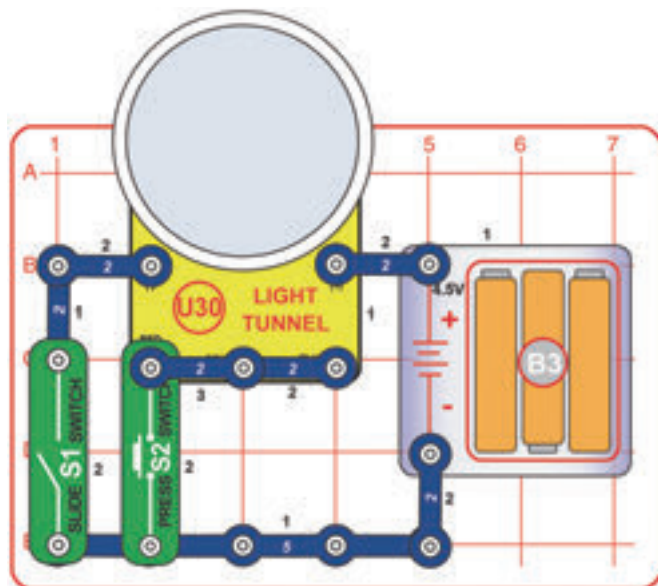

This circuit is a simple check that the light tunnel is working properly, and is referenced by the Advanced Troubleshooting procedure.



Push and release the press switch (S2); 9 LEDs (3 red, 3 green, and 3 blue) in the light tunnel (U30) light while the switch is pressed. Now turn on the slide switch (S1); the 9 LEDs go on and off in a repeating pattern.



Project 137

High Wind Alarm

Build the circuit as shown; note that there are five vertical snap wires (V1) standing up. Place a small piece of paper between the two 2-snap wires as shown, and position it to hang down and block the light between the white LED (D6) and the phototransistor (Q4). Place the circuit in a dimly lit room. Turn on the slide switch (S1); the white LED should be on, but there should be no sound. If there is sound, move the circuit away from room lights, or adjust the position of the piece of paper until the sound is off. Now blow on the lower (hanging) side of the paper, moving it up enough for light from the white LED to reach the phototransistor, which makes the horn (W1) sound. Adjust the position of the paper as needed so that blowing on it triggers the "high wind alarm".

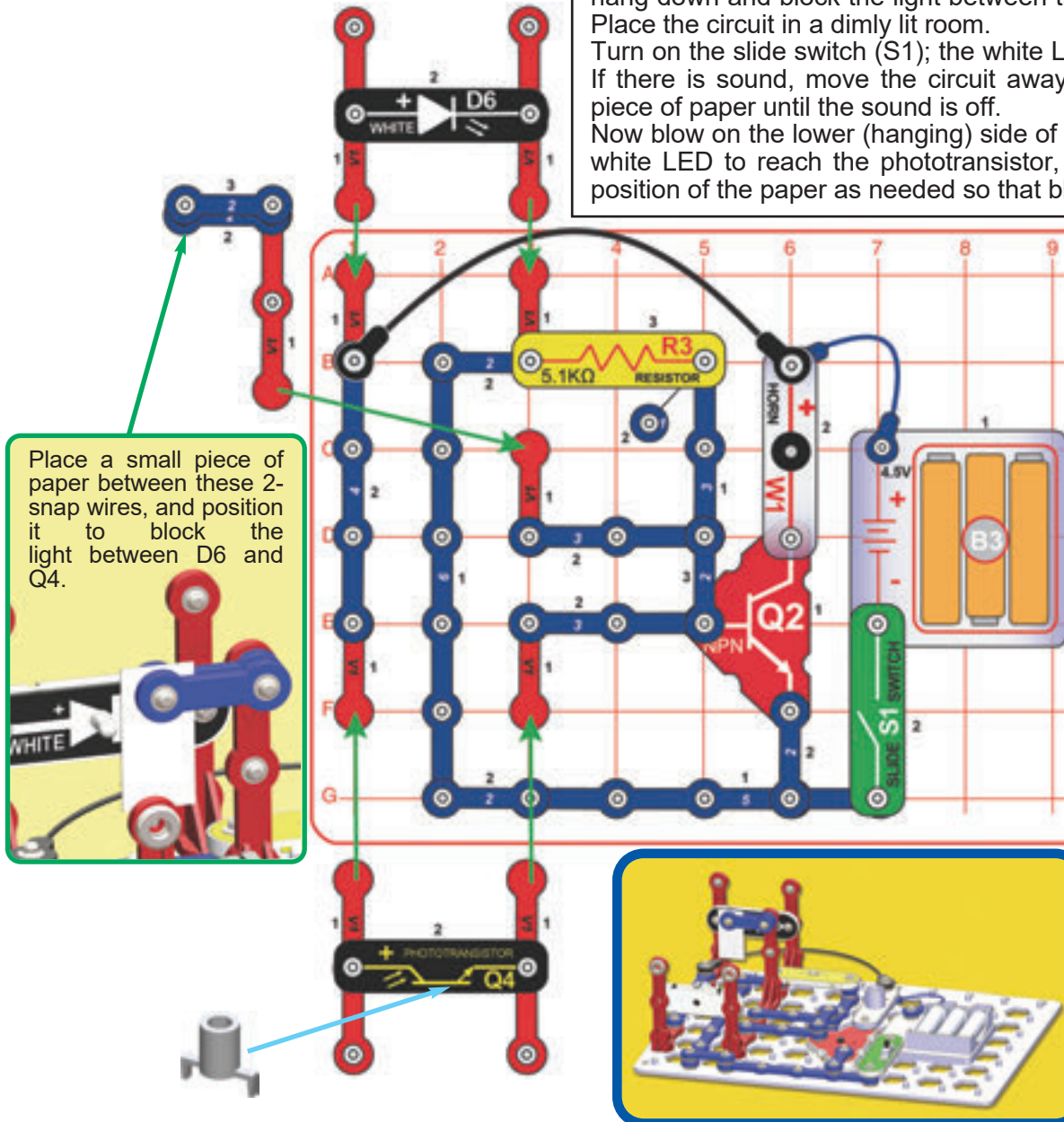

Place a small piece of paper between these 2-snap wires, and position it to block the light between D6 and Q4.



Project 138

Hit the 2-Snap

Use the preceding circuit, but remove the two 2-snap wires and paper, and instead place a single 2-snap one snap down on the vertical snap wire, as shown. The 2-snap should be blocking the light between the white LED (D6) and the phototransistor (Q4), and the sound should be off. Gently toss a stabilizer at the loose side of the 2-snap (the "target"). When you hit it and knock it out of position, light from the white LED reaches the phototransistor and triggers the horn (W1), indicating success.

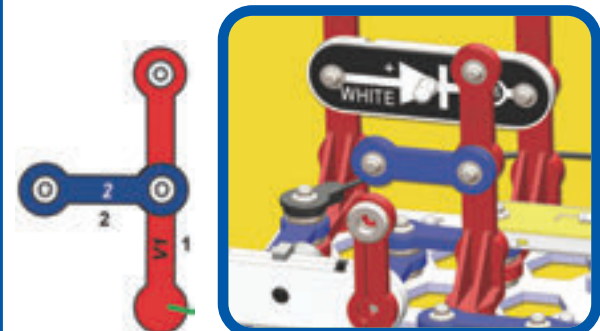
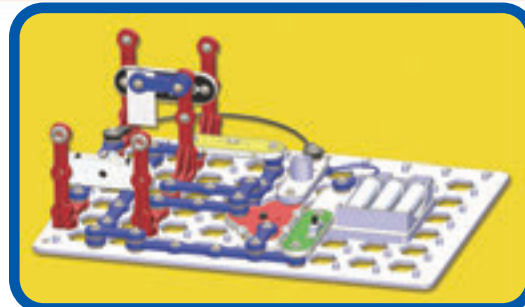



Project 139

Free Mirror Circuit



MIRROR

Use as per instructions

When installed backwards, the color LED's color changing microcircuit acts like a small electric speed bump. It is used here to regulate the voltage to the NPN transistor (Q2), so that room lights do not easily trigger the alarm.

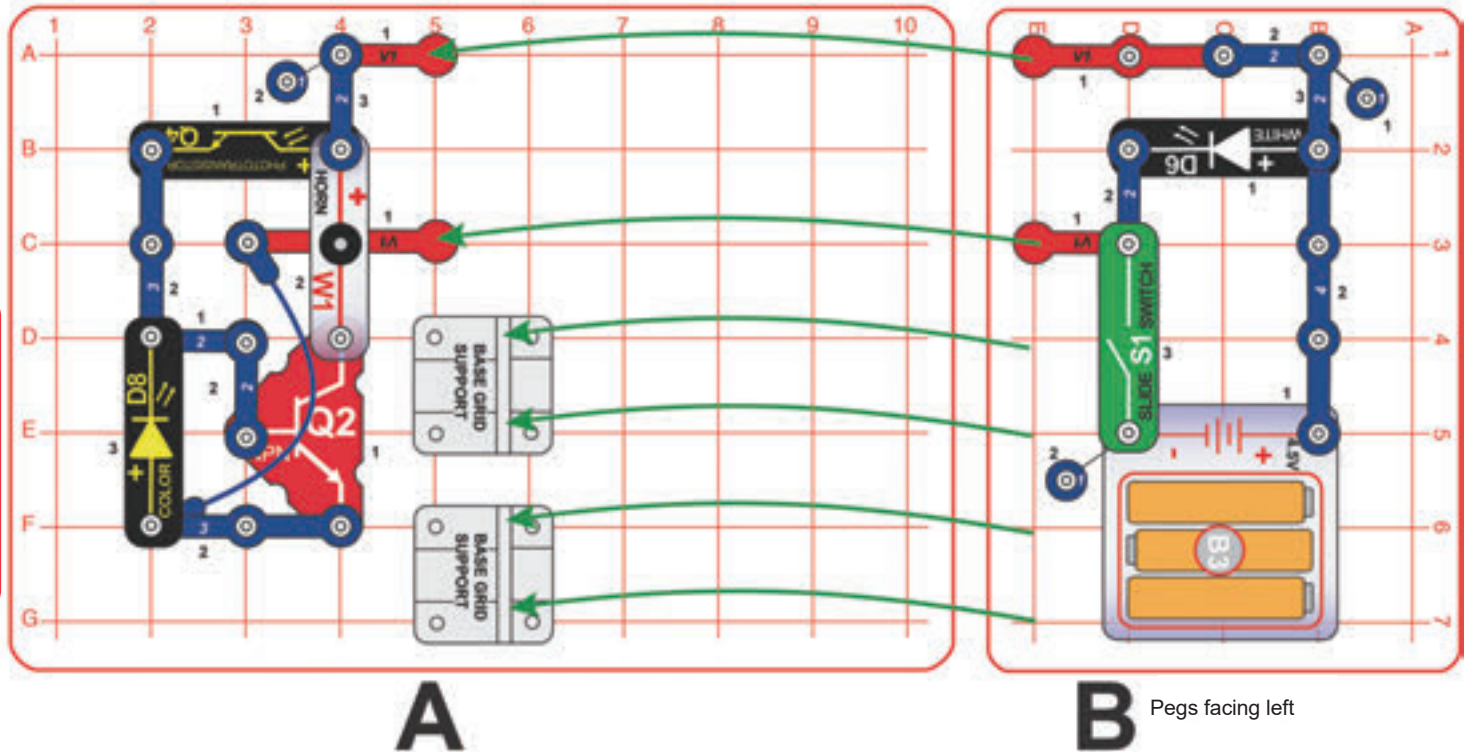

A

B

Pegs facing left

Assembly:

1. Place base grid supports on base grid A.
2. Place parts on grid B, and install into base grid supports on grid A.
3. Install remaining parts on grid A.

Turn on the slide switch (S1); the white LED should be on, but there should be no sound. If there is sound, move the circuit away from room lights.

Hold a mirror so that light from the white LED (D6) is reflected to the phototransistor (Q4); an alarm sounds when you succeed.

The color LED (D8) is intentionally installed backwards and will not light.

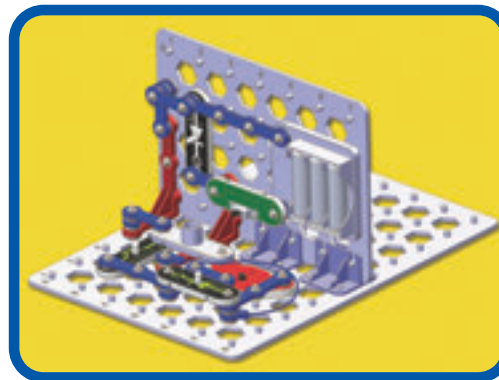

Project 140 Floor Mirror Circuit

Use the preceding circuit, but make sure everything is securely snapped. Carefully place the circuit upside down on the floor or a table, then slide the mirror under it, as shown. When the mirror reflects light from the white LED (D6) to the phototransistor (Q4); an alarm sounds indicating success.

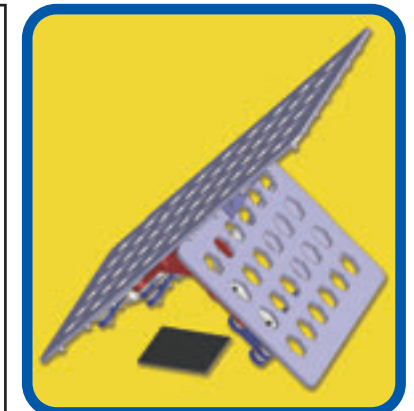

Project 141

Box Circuit

Assembly (adult supervision recommended):

1. Place battery holder (B3) and base grid supports on base grid A.
 2. Place parts on base grids B & D, and install into base grid supports on grid A. The pegs should be facing inward.
 3. Install grids C & E into base grid supports on grid A, attaching the 4 vertical snap wires (V1) as you do it.
 4. Add the 4 stabilizers to help secure grids B-E together.
 5. Place the remaining parts on grids A, C, & E.
- Turn on the slide switch (S1) to light the LEDs (D6 & D8).



This circuit can also be used to store all your SC-3Di parts.

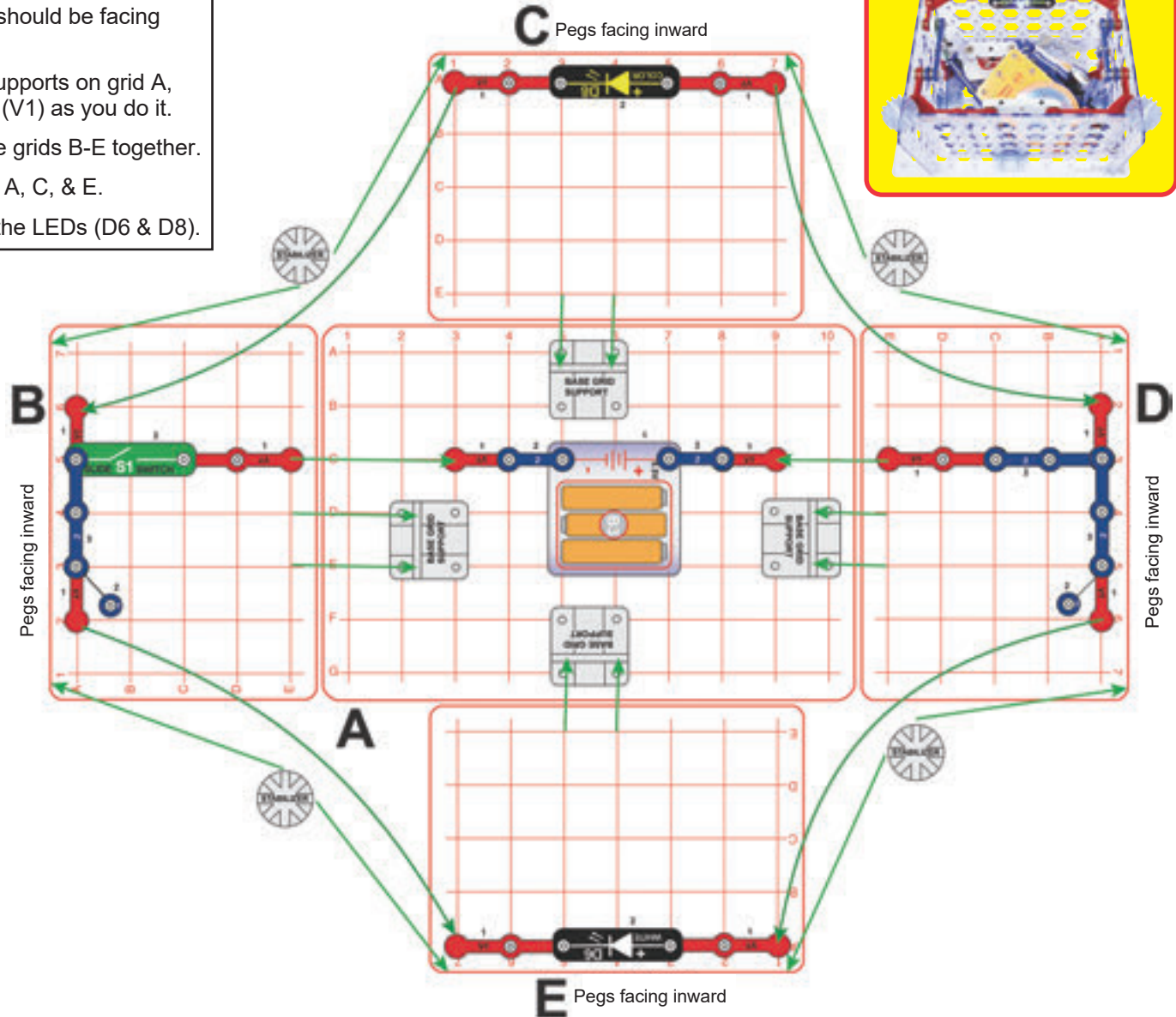
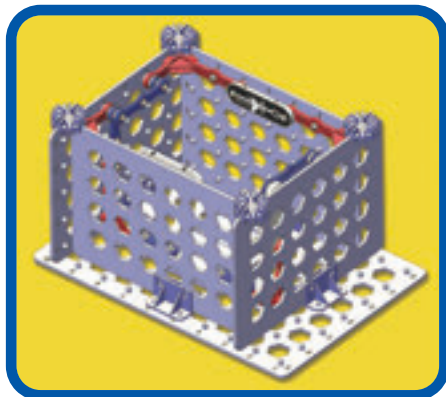
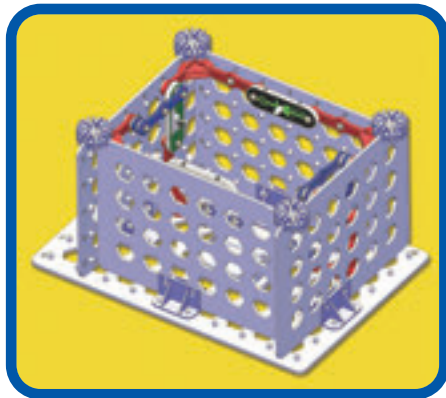

Project 142

Burglar Alarm Box

Assembly

(adult supervision recommended):

1. Place battery holder (B3) and base grid supports on base grid A.
2. Place parts on grid E, and install into base grid support on grid A. The pegs should be facing inward.
3. Place parts on base grids B & D, except for the 2 vertical snap wires (V1) that attach to grid E and the parts connected to them.
4. Install grids B & D into base grid supports on grid A, attaching the vertical snap wires (and the parts connected to them) on grid E as you do it. The pegs should be facing inward.
5. Install grid C into base grid supports on grid A, attaching the 2 vertical snap wires as you do it.
6. Add the 4 stabilizers to help secure grids B-E together.
7. Place the remaining parts on grids A & C.
8. Place the Q4 attachment on the phototransistor (Q4).

Turn on the slide switch (S1); the white LED (D6) is on, but there is no sound. An alarm sounds if you reach in and block the light between the white LED and phototransistor.

You can place something in this box, and have an alarm sound if someone tries to take it.

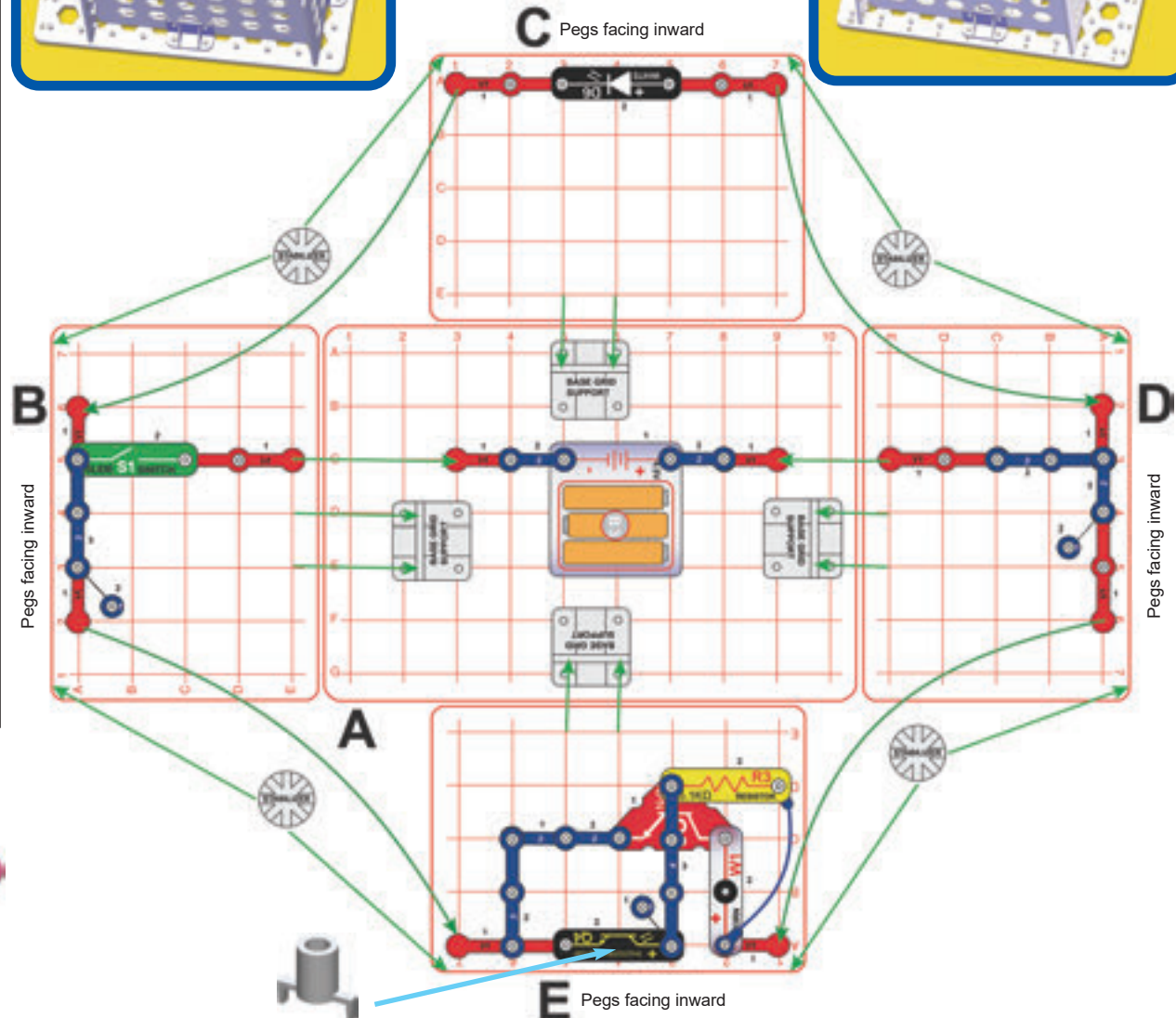
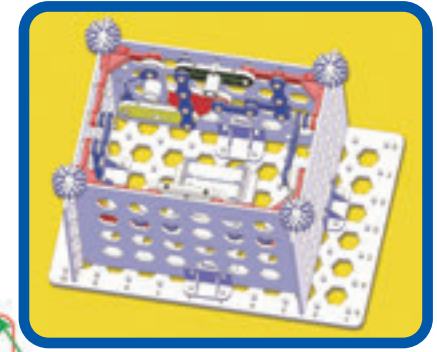

Project 143

Outer Lights House

Assembly (adult supervision recommended):

1. Place base grid supports on base grid A.
2. Place parts on grids B & C (except jumper wires), and install into base grid supports on grid A. The pegs on grids B & C should be facing outward.
3. Place parts (except jumper wires) on grids A & D.
4. Mount grid D on top of grids B & C using 4 stabilizers.
5. Add the jumper wires (2 blue, 1 red, and 1 black). Since the blue wires are short, be sure to put them through the holes in grid C, as shown in the pictures on the right.

Turn on the slide switch (S1) to activate the LEDs (D6 & D8), and light tunnel (U30).

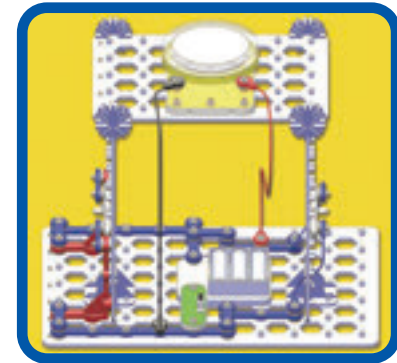
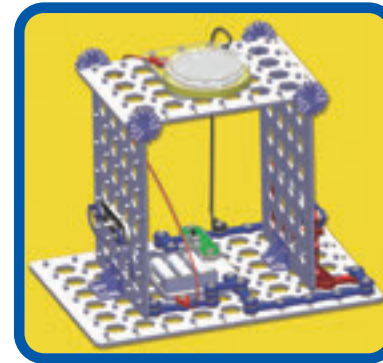
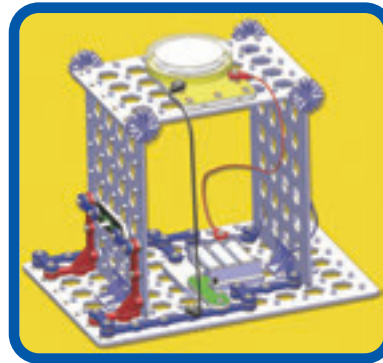

D Pegs facing up

Side view:

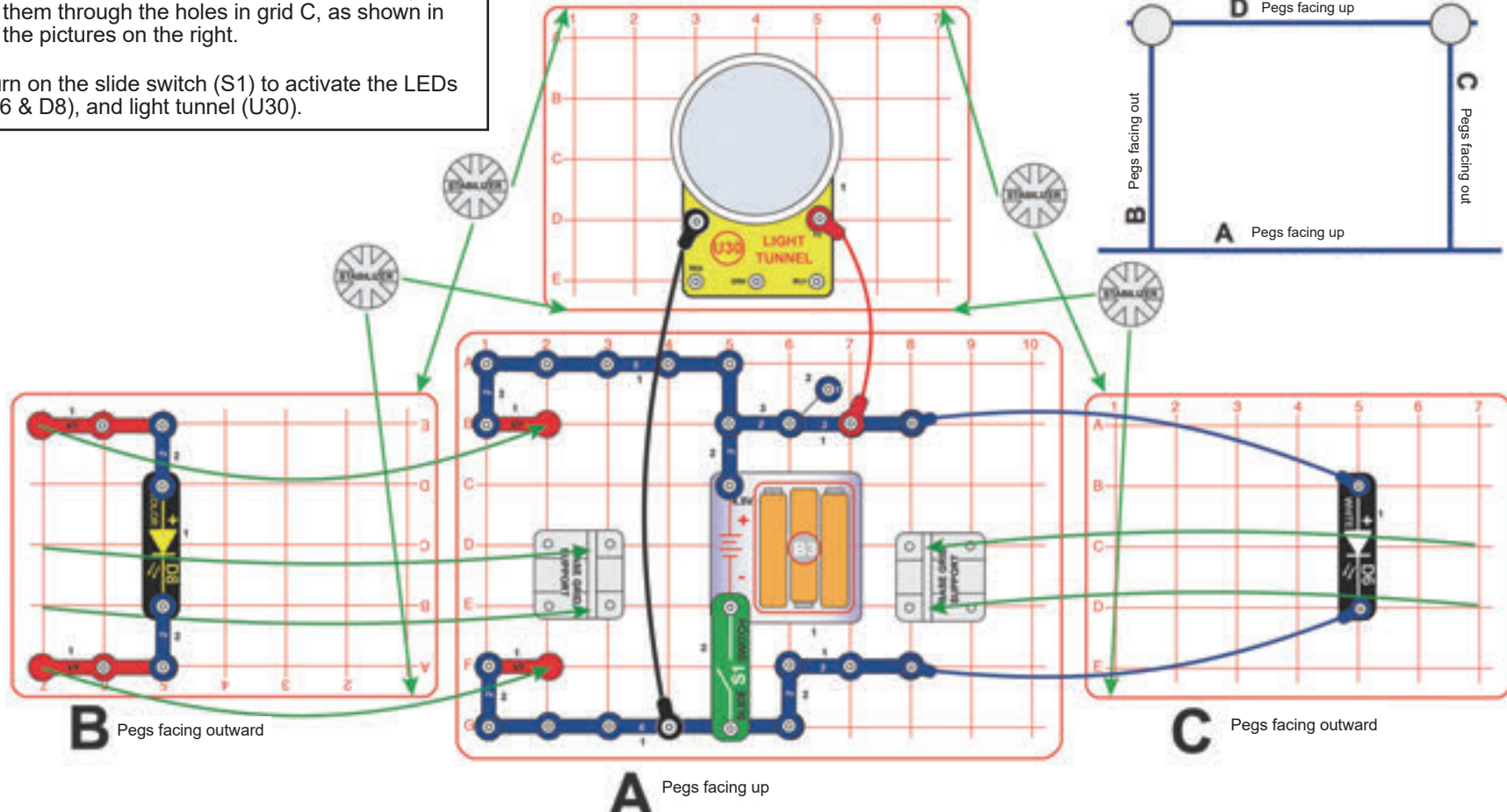
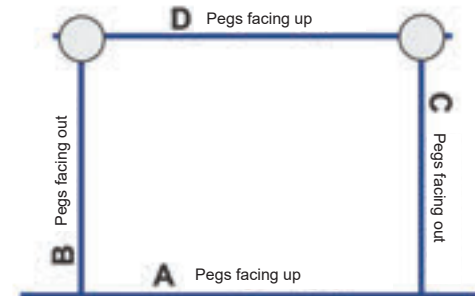

Project 144

Light Tunnel Tower

Assembly (adult supervision recommended):

1. Place base grid supports on base grids A & D.
2. Install base grids B & C into base grid supports on grid A. The pegs should be facing inward.
3. Place parts on base grid E, and install into base grid support on grid D. The pegs on grid E should be facing forward.
4. Mount grid D (with grid E on it) on top of grids B & C using 4 stabilizers.
5. Place the remaining parts on grid A.
6. Connect the red & black jumper wires.

Turn on the slide switch (S1) to light the light tunnel (U30).



You can use this circuit to signal someone in the distance.

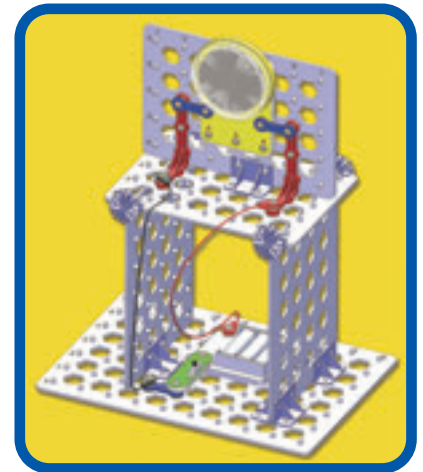
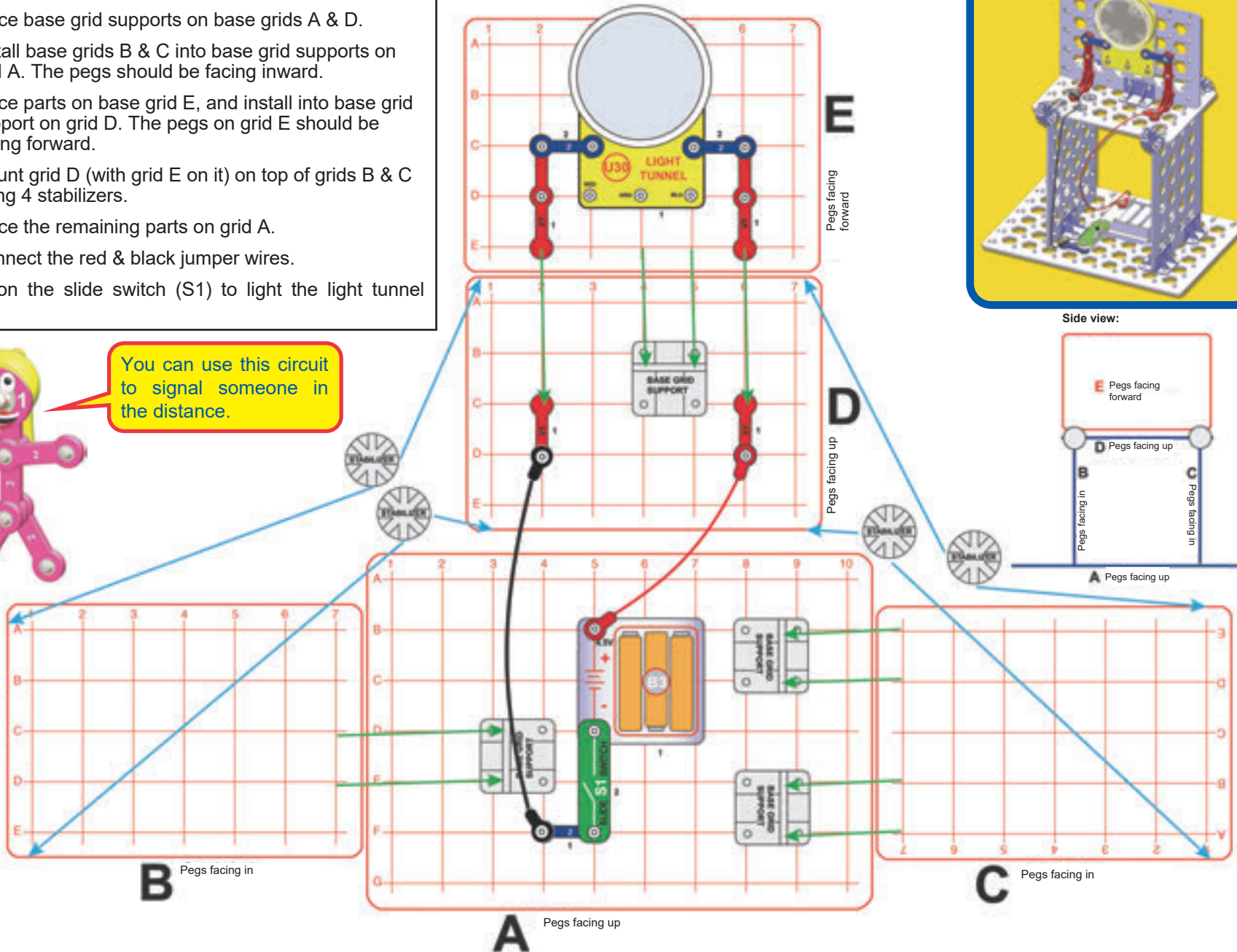

Side view:

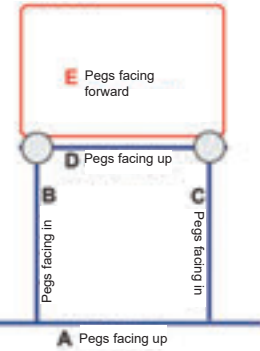



Project 145 Morse Code

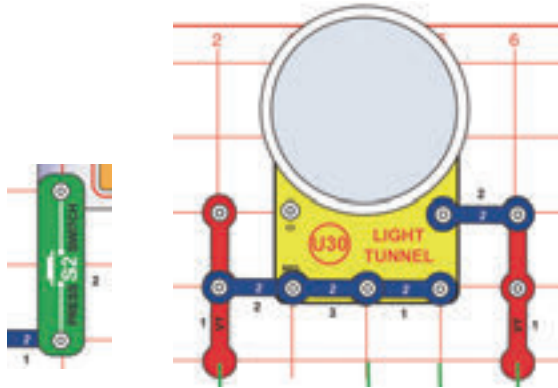

With a few changes, the preceding circuit can be used to send messages. Replace the slide switch (S1) with the press switch (S2), and modify the connections to the light tunnel (U30) as shown. Push the press switch several times to send messages using Morse Code.

Morse Code: The forerunner of today's telephone system was the telegraph, which was widely used in the latter half of the 19th century. It only had two states - on or off (that is, transmitting or not transmitting), and could not send the range of frequencies contained in human voices or music. A code was developed to send information over long distances using this system and a sequence of dots and dashes (short or long transmit bursts). It was named Morse Code after its inventor. It was also used extensively in the early days of radio communications, though it isn't in wide use today. It is sometimes referred to in Hollywood movies, especially Westerns. Modern communications systems send data across the country using similar coding systems, but at much higher speeds.

MORSE CODE

A	· -	N	· ·	Period	· - - -
B	- · - ·	O	- -	Comma	· - - -
C	- · - · - ·	P	· - - -	Question	· - · - ·
D	- · - ·	Q	· - - -	1	· - - -
E	· -	R	· - · -	2	· - - -
F	· - · -	S	· · - -	3	· - - -
G	· - - ·	T	· -	4	· - - -
H	· - · - ·	U	· - ·	5	· - - -
I	· ·	V	· - · -	6	· - - -
J	· - - -	W	· - - ·	7	· - - -
K	- · -	X	- · - ·	8	· - - -
L	- · - ·	Y	- · - -	9	· - - -
M	- -	Z	- - · -	0	· - - -



Project 146 Tower of Lights

Use the project 145 circuit, but replace the light tunnel (U30) with the white & color LEDs (D6 & D8), as shown. Push on the press switch (S2) to light the LEDs. Send messages to your friends using Morse Code, as described in project 145.

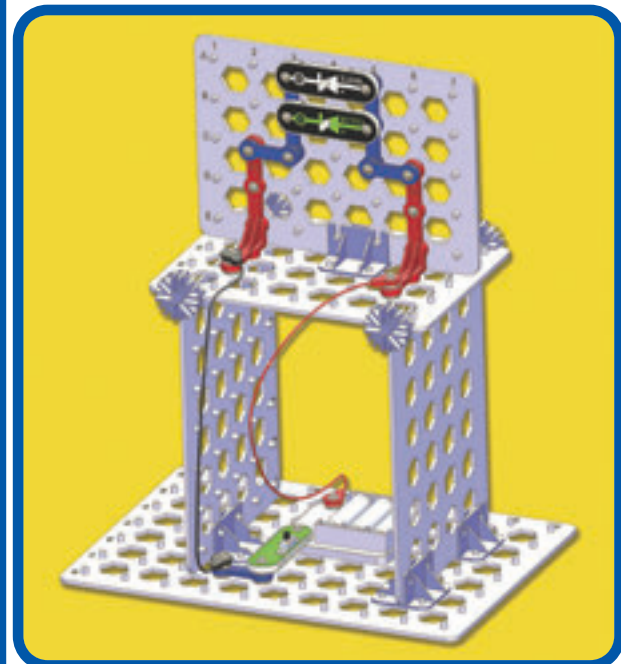
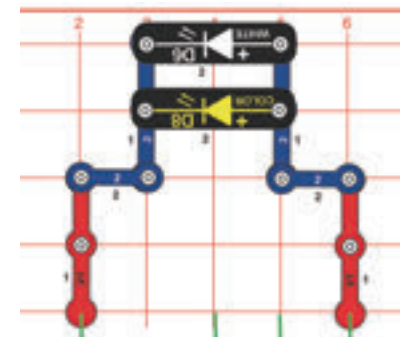



Project 147

Light-Controlled Light Tunnel

Build the circuit and turn on the slide switch (S1). The light tunnel (U30) will be on if there is enough light on the phototransistor (Q4), so vary the amount of light shining on the phototransistor.

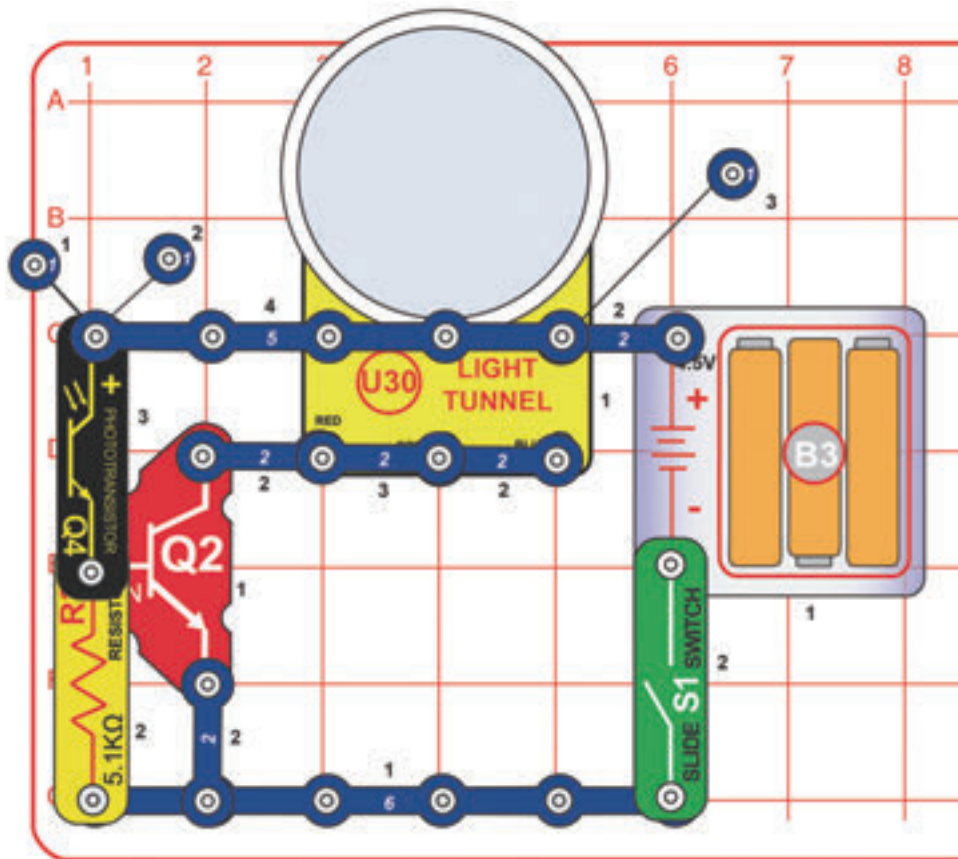

Project 148

IR-Controlled Light Tunnel

You need an infrared remote control for this project, such as any TV/stereo/DVD remote control in your home.

Use the preceding circuit, but position it away from lights in the room so that the light tunnel (U30) is off. If needed, place the Q4 attachment on the phototransistor (Q4) to help shield it from room lights. Point your remote control directly at the phototransistor (or into the Q4 attachment), and press any button to turn on the light tunnel.

Note that when the phototransistor is activated by room lights the light tunnel is on continuously, and when the phototransistor is activated by your infrared remote control then the light tunnel will be blinking.

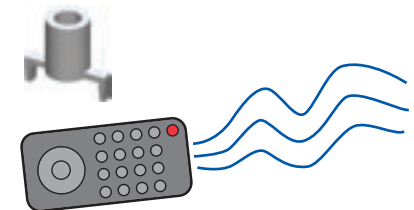



Project 149

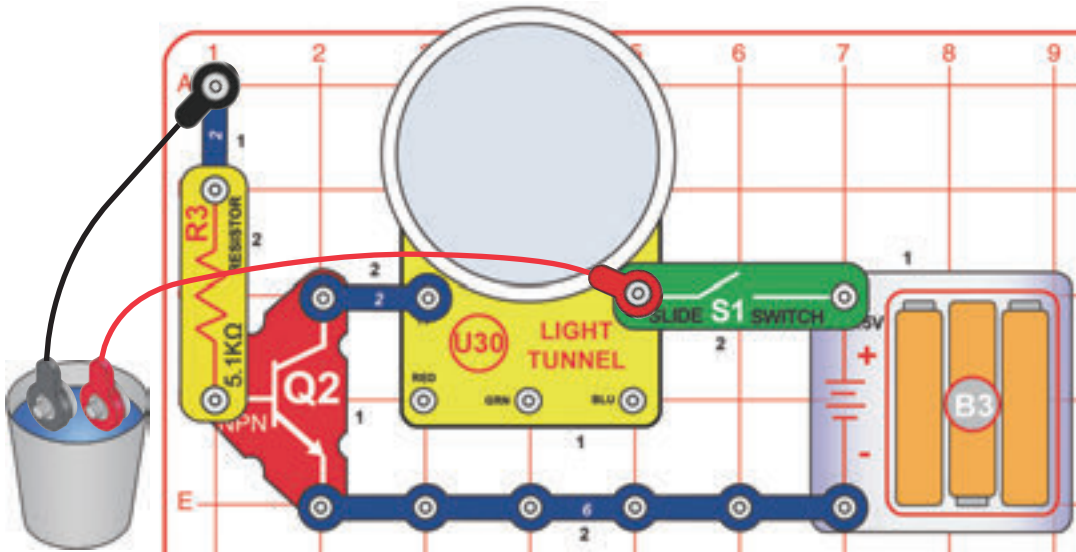

Liquid Conductor

Build the circuit as shown, leaving the ends of the red & black jumper wires unconnected for now. Turn on the slide switch (S1); the light tunnel (U30) should be off.

Place the loose ends of the red & black jumper wires into a cup of water (but not distilled water), without them touching each other. The light tunnel should be on now, because water conducts electricity, completing this circuit. Don't drink any water used here.



Project 150

Human Conductor

Use the preceding circuit, but instead of placing the red & black jumper wires in water, touch the metal part of each with your fingers, using your body to complete the circuit. Wet your fingers to get better electrical contact. The light tunnel (U30) should be on, but brightness may vary.



Project 151

Water Completes the Circuit

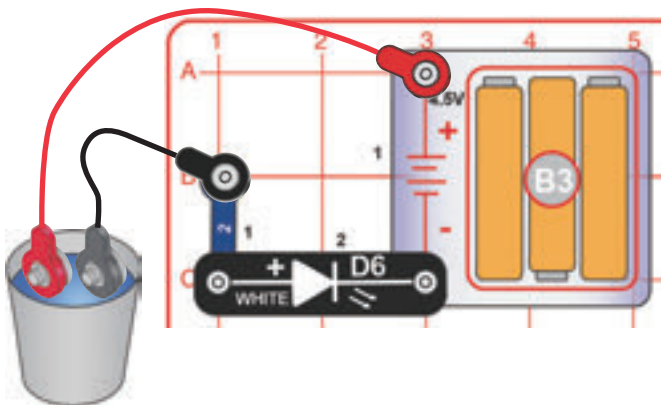

Build the circuit as shown, leaving the ends of the red & black jumper wires unconnected for now. Turn on the slide switch (S1); the white LED (D6) should be off.

Place the loose ends of the red & black jumper wires into a cup of water (but not distilled water), without them touching each other. The white LED should be on now, because water conducts electricity, completing this circuit.

Try dissolving some salt in the water or using different liquids, and see how the LED brightness changes. You can also replace the white LED with the color LED (D8).

Don't drink any liquids used here.



Project 152

You Complete the Circuit

Use the preceding circuit, but instead of placing the red & black jumper wires in water, touch the metal part of each with your fingers, using your body to complete the circuit. Wet your fingers to get better electrical contact. The white LED (D6) should be on, but brightness may vary.



Project 153

Mirrors on a Wall

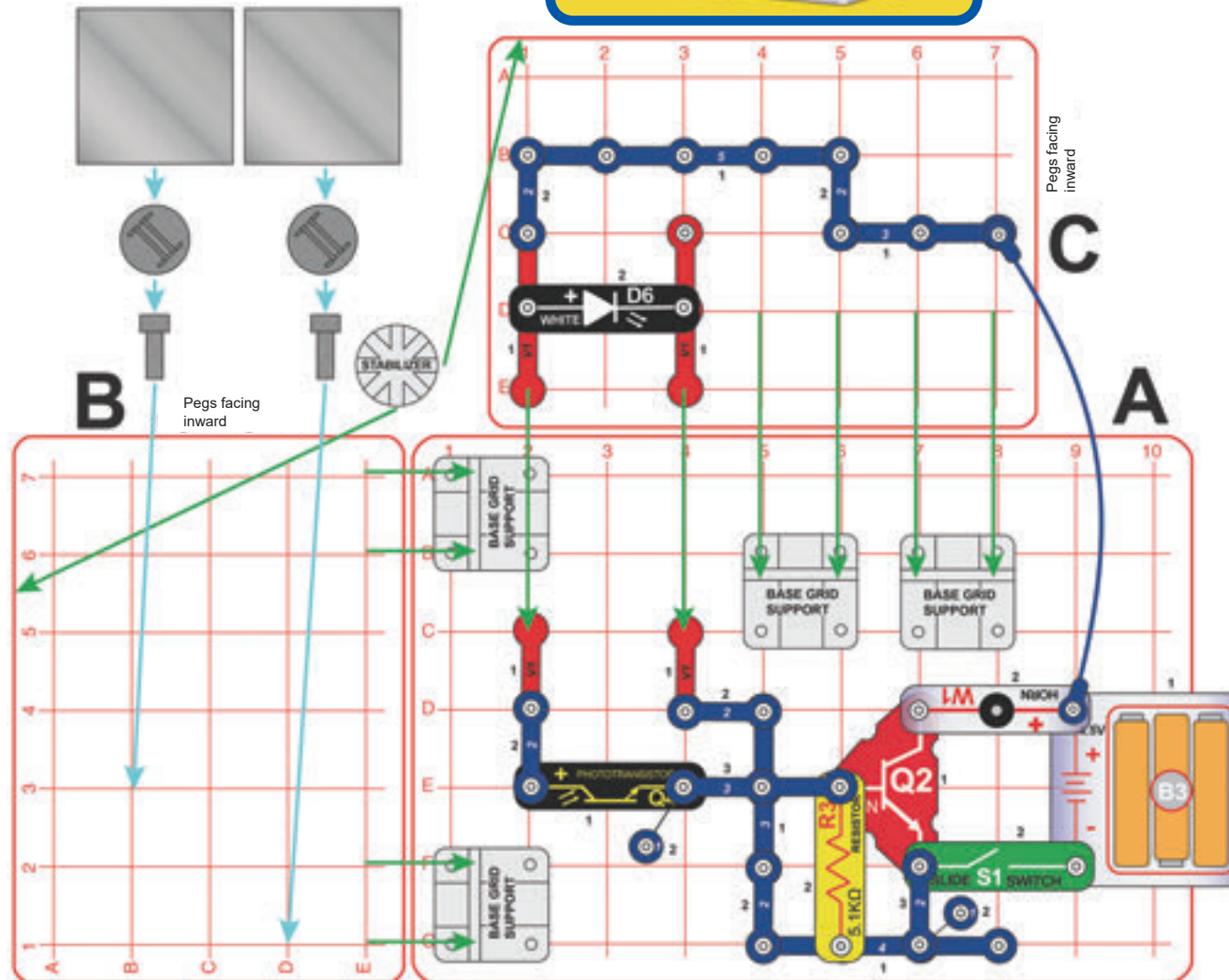
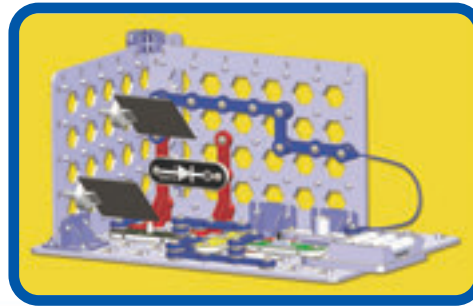

- Assembly (adult supervision recommended):
1. Place base grid supports on base grid A.
 2. Place parts on grid C (except the blue jumper wire) and install into base grid support on grid A.
 3. Install grid B into base grid supports on grid A.
 4. Install a stabilizer between grids B & C.
 5. Install remaining parts on grid A and blue jumper wire.
 6. Place the springs at the locations shown on grid B.

Turn on the slide switch (S1); the white LED (D6) should be on. If the horn (W1) is also on, then dim the room lights. Place the mirrors in the mirror holders, and place them in the springs so that light from the white LED is reflected from the lower mirror to the upper mirror, and then to the phototransistor (Q4); the horn sounds when you succeed. Once the mirrors are aligned or close to it, tap the mirrors gently with your finger so they bounce, making the sound beeping.

Notes: It can be difficult to shift the mirror holder position in the spring, so to change the position of the mirror on the spring, remove the holder from the spring and re-insert it. To help align the mirrors, dim the room lights and look at where the reflected light is shining, and make adjustments as needed. Be sure the mirrors are clean.



Project 154

Color Light Box

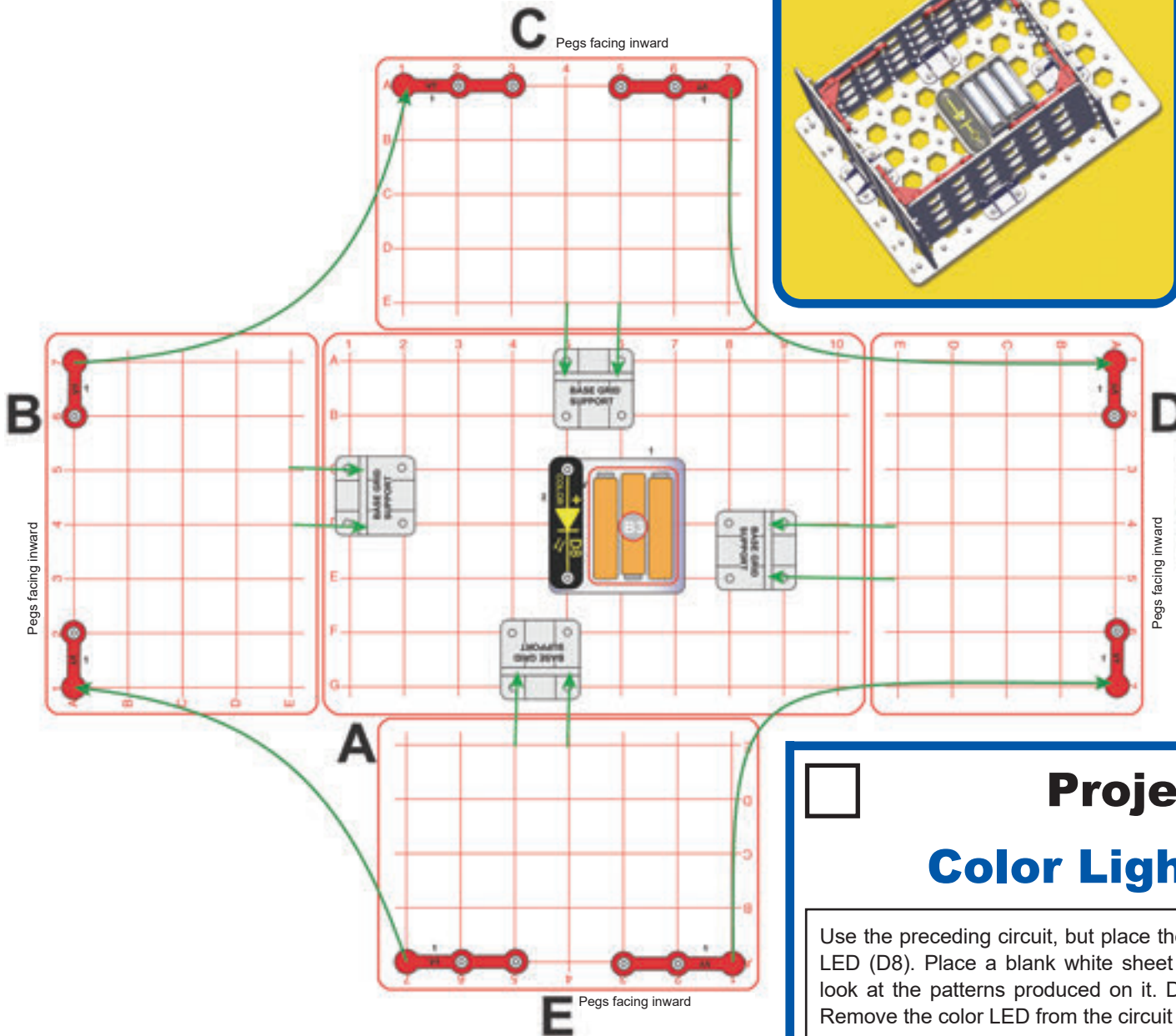
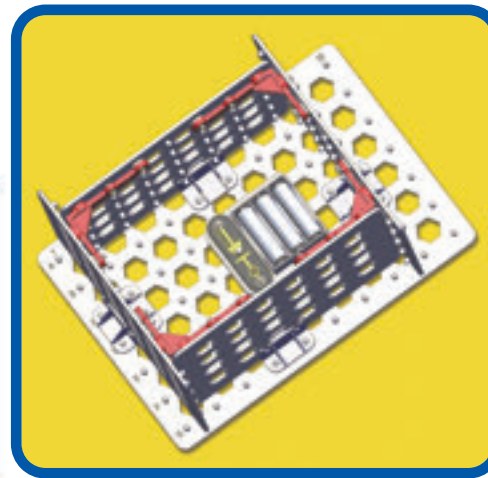

Assembly:

1. Place battery holder (B3) and base grid supports on base grid A.
2. Place parts on base grids B & D, and install into base grid supports on grid A. The pegs should be facing inward.
3. Install grids C & E into base grid supports on grid A, attaching the 4 vertical snap wires (V1) as you do it.
4. Place the color LED (D8) on the battery holder.

The color LED should be on (there is no on/off switch). Place a blank sheet of white paper on top of the circuit walls, and dim the room lights. You should see red, green, and blue circles shining through the paper. Remove the color LED from the circuit when you are finished.



Project 155

Color Light Box Lens

Use the preceding circuit, but place the lined lens attachment on the color LED (D8). Place a blank white sheet of paper over the circuit walls and look at the patterns produced on it. Dim the room lights for best effects. Remove the color LED from the circuit when you are finished.



Project 157

Mini Overhead Light

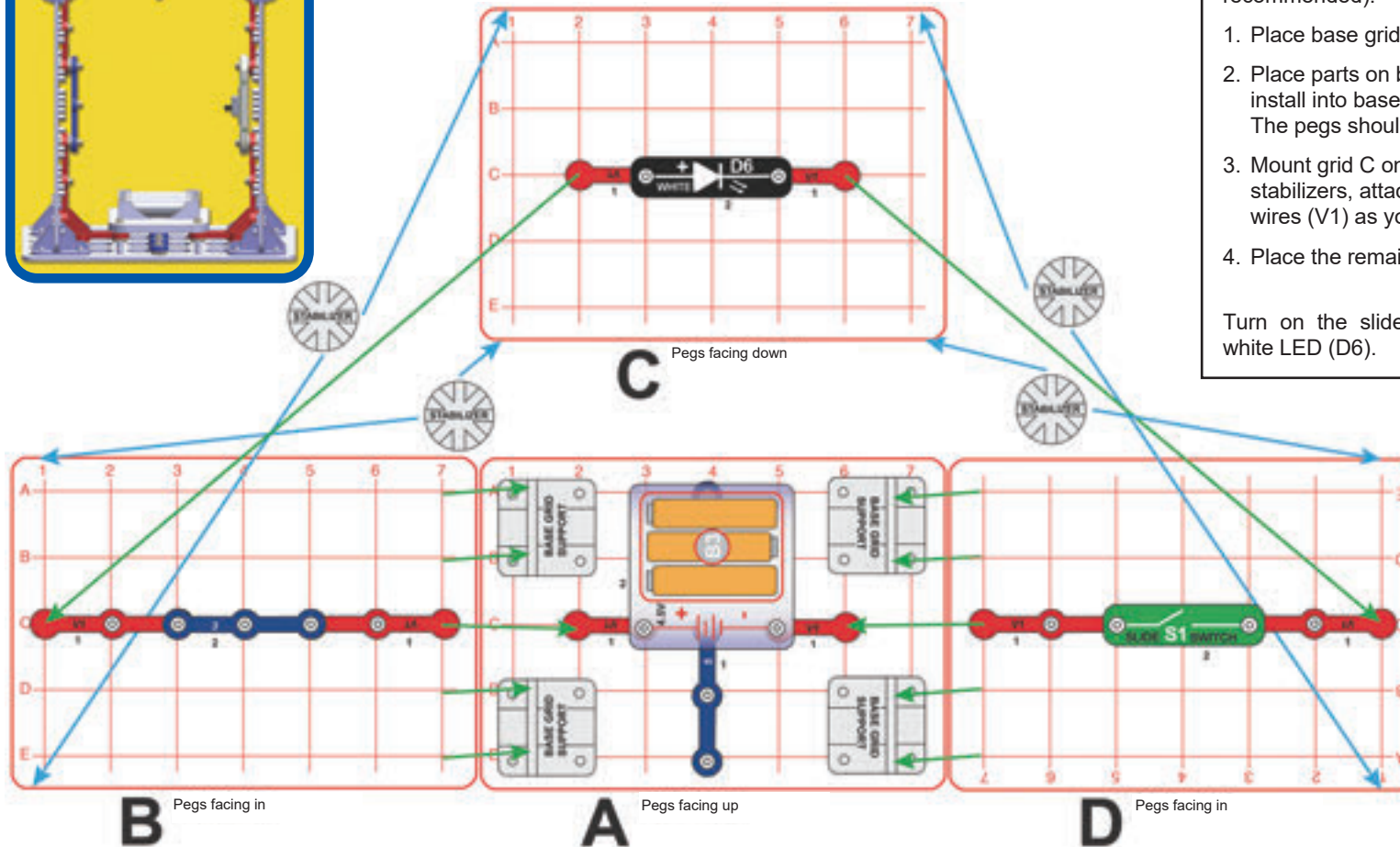
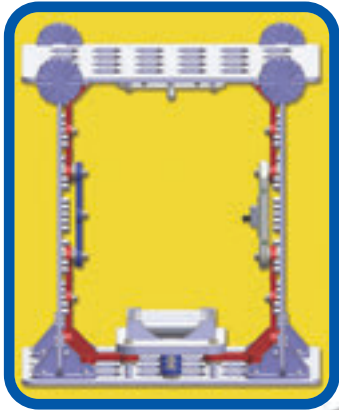

This circuit is similar to project 21, but smaller. Assembly (adult supervision recommended):

1. Place base grid supports on base grid A.
2. Place parts on base grids B, & D, and install into base grid supports on grid A. The pegs should be facing inward.
3. Mount grid C on top of grids B & D using 4 stabilizers, attaching the 2 vertical snap wires (V1) as you do it.
4. Place the remaining parts on grids A & C.

Turn on the slide switch (S1) to light the white LED (D6).

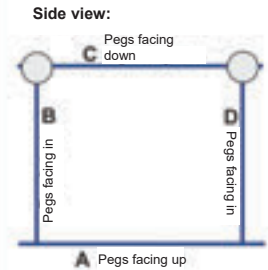

Project 158 Mini Overhead Lights

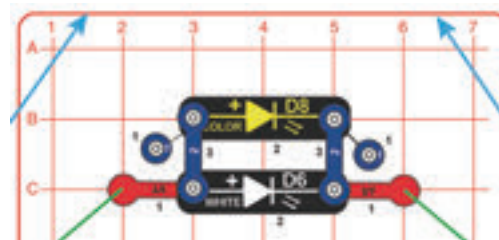

Use the preceding circuit, but carefully replace the white LED (D6) with the color LED (D8), or carefully add the color LED next to the white LED as shown here.



Project 159

Floor-to-Ceiling Break the Beam

This circuit is similar to project 29.
Assembly (adult supervision recommended):

1. Place base grid supports on base grid A.
2. Place parts on base grids B, & D, and install into base grid supports on grid A. The pegs should be facing inward.
3. Mount grid C on top of grids B & D using 4 stabilizers, attaching the 2 vertical snap wires (V1) as you do it.
4. Place the remaining parts on grids A & C.
5. Place the Q4 attachment on the phototransistor (Q4).

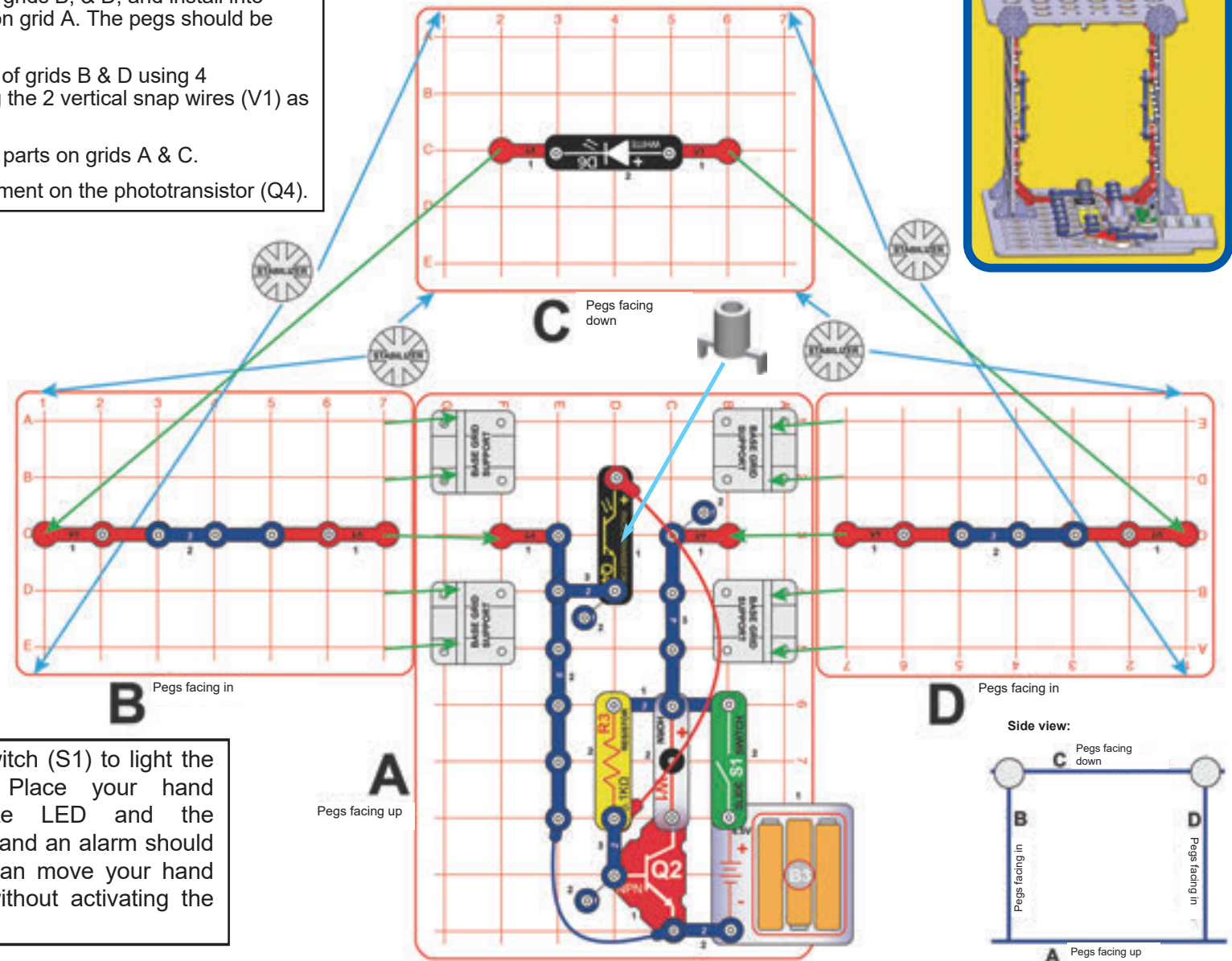

Turn on the slide switch (S1) to light the white LED (D6). Place your hand between the white LED and the phototransistor (Q4) and an alarm should sound. See if you can move your hand through the “box” without activating the alarm.

Going Further

The structures shown below require additional Boffin parts that are not included in this set, but may be part of other Boffin sets you already have. They are provided here as examples of what can be made by combining this set with others. If you experiment further on your own then be sure to follow the guidelines in the DOs and DON'Ts pages of your manuals (page 8 of this manual). You may purchase additional Boffin parts at www.toy.cz

For assembly instructions and additional photos of these structures, go to: www.toy.cz

Big Structure



House of Lights





WWW.TOY.CZ

ConQuest entertainment a.s.

Kolbenova 961, 198 00 Praha 9

www.boffin.cz

info@boffin.cz