

BOFFIN 300

Electronic kit



Flash frequency



WARNING: This toy produces flashes that may trigger epilepsy in sensitised individuals.

Only for use by children aged 8 years and older. Not suitable for children and under 8 years due to small parts which could cause a choking hazard.

Light bulb warning



WARNING! Hot surface, do not touch bulb.



Overview: Amendments of the new EN 62115: 2020/A11:2020 concerning batteries and LEDs

Batteries

Small batteries

Batteries that fit wholly within the small parts cylinder (as specified in §8.2 of EN 71-1:2014+A1:2018) shall not be removable without the aid of a tool.

For parts of electric toys containing batteries, where the part fits wholly within the small parts cylinder (as specified in 8.2 of EN 71-1:2014+A1:2018), batteries shall not be accessible without the aid of a tool.

Other batteries

Batteries shall not be removable without the aid of a tool unless the security of the battery compartment cover is adequate.

Compliance is checked by inspection and by the following test. An attempt is made to gain access to the battery compartment by manual means. It shall not be possible to open the cover unless at least two independent movements have to be applied simultaneously.

The electric toy is placed on a horizontal steel surface.

A cylindrical metallic mass of 1 kg, having a diameter of 80 mm, is dropped from a height of 100 mm so that its flat face falls onto the electric toy. The test is carried out once with the cylindrical metallic mass striking the electric toy in the most unfavourable place. The battery compartment shall not become open.

- ▶ So all batteries need a battery cover in future, which complies with the specifications above.

Batteries supplied with the toy

Primary batteries supplied with electric toys shall comply with the relevant parts of the IEC 60086 series.

- ▶ A Pass Test Report is needed.

Secondary batteries supplied with electric toys shall comply with IEC 62133.

- ▶ A Pass Test Report is needed.

Battery compartment fasteners

If screws or similar fasteners are used to secure a door or cover providing access to the battery compartment, the screw or similar fastener shall be captive to ensure that they remain with the door, cover or equipment.

Compliance is checked by inspection and by the following test after the battery door or cover is opened. A force of 20N is applied to the screw or similar fastener without jerks for a duration of 10s in any direction.

The screw or similar fastener shall not become separated from the door, cover or equipment.

Light-emitting diodes

The emission from electric toys incorporating LEDs shall not exceed the following limits:

- 0,01 Wm⁻² when assessed at 10 mm from the LED front for accessible emissions with wavelengths of < 315 nm;
- 0,01 Wsr⁻¹ or 0,25 Wm⁻² when assessed at 200 mm, for accessible emissions with wavelengths of 315 nm ≤ λ < 400 nm;

- 0,04 Wsr⁻¹ or the AEL specified in Tables E.2 or E.3 assessed at 200 mm for accessible emissions with wavelengths of 400 nm ≤ λ < 780 nm;
- 0,64 Wsr⁻¹ or 16 Wm⁻² when assessed at 200 mm for accessible emissions with wavelengths of 780 nm ≤ λ < 1 000 nm;
- 0,32 Wsr⁻¹ or 8 Wm⁻² when assessed at 200 mm for accessible emissions with wavelengths of 1 000 nm ≤ λ < 3 000 nm.

LED data sheets

As the technical data sheet is essential for compliance with this standard, it shall be developed following the measurement criteria of condition A or condition B of CIE 127. The technical data sheet shall indicate that it has been created using the CIE 127 measurement methods and as a minimum include:

- the luminous intensity in candela or radiant intensity in Watts per steradian as a function of forward current,
- the angle,
- the peak wavelength,
- the spectral emission bandwidth,
- the date of issue and the revision number.

- ▶ So all LEDs need a LED data sheet in future, which includes the specifications above.

300
PROJECTS

60
PARTS



Table of Contents

Basic Troubleshooting	1	<i>MORE</i> Advanced Troubleshooting	5
Parts List	2	Project Listings	6, 7
<i>MORE</i> About Your Boffin Parts	3	Projects 102 - 305	8 - 73
<i>MORE</i> DO's and DON'Ts of Building Circuits	4	Other Fun ConQuest entertainment a.s. Products	74

 **WARNING TO ALL PARTS WITH A  SYMBOL** - Moving parts. Do not touch the motor or fan during operation. Do not lean over the motor. Do not launch the fan at people, animals, or objects. Eye protection is recommended. 

 **WARNING: SHOCK HAZARD** - Never connect Boffin to the electrical outlets in your home in any way!

 **WARNING: CHOKING HAZARD** - Small parts. Not for children under 3 years.

WARNING: Always check your wiring before turning on a circuit. Never leave a circuit unattended while the batteries are installed. Never connect additional batteries or any other power sources to your circuits. Discard any cracked or broken parts.

Basic Troubleshooting

1. Most circuit problems are due to incorrect assembly. Always double-check that your circuit exactly matches the drawing for it.
2. Be sure that parts with positive/negative markings are positioned as per the drawing.
3. Sometimes the light bulbs come loose, tighten them as needed. Use care since glass bulbs can shatter.
4. Be sure that all connections are securely snapped.
5. Try replacing the batteries.
6. If the motor spins but does not balance the fan, check the black plastic piece with three prongs on the motor shaft. Be sure that it is at the top of the shaft.

ConQuest entertainment a.s. is not responsible for parts damaged due to incorrect wiring.

Note: If you suspect you have damaged parts, you can follow the Advanced Troubleshooting procedure on page 5 to determine which ones need replacing.

Batteries:

- Use only 1.5V AA type, alkaline batteries (not incl.).
- Insert batteries with correct polarity.
- Non-rechargeable batteries should not be recharged. Rechargeable batteries should only be charged under adult supervision, and should not be recharged while in the product.
- Do not mix alkaline, standard (carbon-zinc), or rechargeable (nickel-cadmium) batteries.
- Do not mix old and new batteries.
- Remove batteries when they are used up.
- Do not short circuit the battery terminals.
- Never throw batteries in a fire or attempt to open its outer casing.
- Batteries are harmful if swallowed, so keep away from small children.

Review of How To Use It

(See p.3 of the Projects 1-101 manual for more details.)

The Boffin kit uses building blocks with snaps to build the different electrical and electronic circuits in the projects. These blocks are in different colors and have numbers on them so that you can easily identify them. The circuit you will build is shown in color and with numbers, identifying the blocks that you will use and snap together to form a circuit.

Next to each part in every circuit drawing is a small number in black. This tells you which level the component is placed at. Place all parts on level 1 first, then all of the parts on level 2, then all of the parts on level 3, etc.

A large clear plastic base grid is included with this kit to help keep the circuit block together. The base has rows labeled A-G and columns labeled 1-10.

Install two (2) "AA" batteries (not included) in the battery holder (B1). The 2.5V and 6V bulbs come packaged separate from their sockets. Install the 2.5V bulb in the L1 lamp socket, and the 6V bulb in the L2 lamp socket.

Place the fan on the motor (M1) whenever that part is used, unless the project you are building says not to use it.

























Some circuits use the red and black jumper wires to make unusual connections. Just clip them to the metal snaps or as indicated.

Note: While building the projects, be careful not to accidentally make a direct connection across the battery holder (a "short circuit"), as this may damage and/or quickly drain the batteries.

Parts List (Colors and styles may vary) Symbols and Numbers

Note: There are additional part lists in your other project manuals.

Important: If any parts are missing or damaged, **DO NOT RETURN TO RETAILER.** Call toll-free +420 284 000 111 or e-mail us at: info@toy.cz. Customer Service • Hloubětínská 11 • Praha 9, 198 00

Qty.	ID	Name	Symbol	Part #	Qty.	ID	Name	Symbol	Part #
□ 3	①	1-Snap Wire		6SC01	□ 1	ⓐ3	10μF Capacitor		6SCC3
□ 3	②	2-Snap Wire		6SC02	□ 1	ⓐ4	100μF Capacitor		6SCC4
□ 1	③	3-Snap Wire		6SC03	□ 1	ⓐ5	470μF Capacitor		6SCC5
□ 1	④	4-Snap Wire		6SC04	□ 1	ⓐ2	1kΩ Resistor		6SCR2
□ 1	⑦	7-Snap Wire		6SC07	□ 1	ⓐ3	5.1kΩ Resistor		6SCR3
□ 1	ⓑ1	Battery Holder - uses 2 1.5V type AA (not Included)		6SCB1	□ 1	ⓐ4	10kΩ Resistor		6SCR4
□ 1	ⓐ1	Antenna Coil		6SCA1	□ 1	ⓐ5	100kΩ Resistor		6SCR5
□ 1	ⓓ2	Green Light Emitting Diode (LED)		6SCD2	□ 1	ⓐ5	High Frequency Integrated Circuit		6SCU5
□ 1	Ⓛ2	6V Lamp Socket 6V Bulb (6.2V, 0.3A) Type 425 or similar		6SCL2 6SCL2B	□ 1	ⓐ1	PNP Transistor		6SCQ1
□ 1	ⓧ1	Microphone		6SCX1	□ 1	ⓐ2	NPN Transistor		6SCQ2
□ 1	ⓐ4	Power Amplifier Integrated Circuit		6SCU4	□ 1	ⓐV	Adjustable Resistor		6SCRV
□ 1	ⓐ1	0.02μF Capacitor		6SCC1	□ 1	ⓐV	Variable Capacitor		6SCCV
□ 1	ⓐ2	0.1μF Capacitor		6SCC2	You may order additional / replacement parts at our website: www.toy.cz				

MORE About Your Boffin Parts

Our Student Guides give much more information about your parts along with a complete lesson in basic electronics. See www.snapcircuits.net/learn.htm or page 74 for more information.

(Part designs are subject to change without notice).

Note: There is additional information in your other project manual.

The green **LED (D2)** works the same as the red LED (D1) and the **6V lamp (L2)** works the same as the 2.5V lamp; these are described in the projects 1-101 manual.

Resistors “resist” the flow of electricity and are used to control or limit the electricity in a circuit. Boffin includes **100 Ω (R1) 1KΩ(R2), 5.1KΩ(R3), 10KΩ(R4), and 100KΩ(R5) resistors** (“K” symbolizes 1,000, so R3 is really 5,100Ω). Materials like metal have very low resistance (<1Ω) and are called conductors, while materials like paper, plastic, and air have near-infinite resistance and are called insulators.

The **adjustable resistor (RV)** is a 50KΩ resistor but with a center tap that can be adjusted between 0Ω and 50KΩ. At the 0Ω setting, the current must be limited by the other components in the circuit.

The **microphone (X1)** is actually a resistor that changes in value when changes in air pressure (sounds) apply pressure to its surface. Its resistance typically varies from around 1KΩ in silence to around 10KΩ when you blow on it.

Capacitors are components that can store electrical pressure (voltage) for periods of time, higher values have more storage. Because of this storage ability they block unchanging voltage signals and pass fast changing voltages. Capacitors are used for filtering and oscillation circuits. Boffin includes **0.02μF (C1), 0.1μF (C2), 10μF (C3), 10μF (C4), 470μF (C5) capacitors, and a variable capacitor (CV)**. The variable capacitor can be adjusted from .00004 to .00022μF and is used in high frequency radio circuits for tuning. The whistle chip (WC) also acts like a 0.02μF capacitor in addition to its sound properties.

The **antenna (A1)** contains a coil of wire wrapped around an iron bar. Although it has magnetic effects similar to those in the motor, those effects are tiny and may be ignored except at high frequencies (like in AM radio). Its magnetic properties allow it to concentrate radio signals for reception. At lower frequencies the antenna acts like an ordinary wire.

The **PNP (Q1) and NPN (Q2) transistors** are components that use a small electric current to control a large current, and are used in switching, amplifier, and buffering applications. They are easy to miniaturize, and are the main building blocks of integrated circuits including the microprocessor and memory circuits in computers. Projects #124-125 and #128-133 demonstrate their properties. A high current may damage a transistor, so the current must be limited by other components in the circuit.

The **power amplifier IC (U4)** is a module containing an integrated circuit amplifier and supporting components that are always needed with it. A description of it is given here for those interested:



Power Amplifier IC:

- (+) - power from batteries
- (-) - power return to batteries
- FIL - filtered power from batteries
- INP - input connection
- OUT - output connection

See project #242 for example of connections.

The **high frequency IC (U5)** is a specialized amplifier used only in high frequency radio circuits. A description of it is given here for those interested:

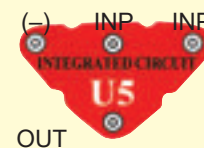

High Frequency IC:

- INP - input connection (2 points are same)
- OUT - output connection
- (-) power return to batteries

See project #242 for example of connections.

DO's and DON'Ts of Building Circuits

After building the circuits given in this booklet, you may wish to experiment on your own. Use the projects in this booklet as a guide, as many important design concepts are introduced throughout them. Every circuit will include a power source (the batteries), a resistance (which might be a resistor, lamp, motor, integrated circuit, etc.), and wiring paths between them and back. **You must be careful not to create "short circuits" (very low-resistance paths across the batteries, see examples below) as this will damage components and/or quickly drain your batteries.** Only connect the ICs using configurations given in the projects, incorrectly doing so may damage them. **ConQuest entertainment a.s. is not responsible for parts damaged due to incorrect wiring.**

Here are some important guidelines:

- ALWAYS** use eye protection when experimenting on your own.
- ALWAYS** include at least one component that will limit the current through a circuit, such as the speaker, lamp, whistle chip, capacitors, ICs (which must be connected properly), motor, microphone, photoresistor, or resistors (the adjustable resistor doesn't count if it's set at/near minimum resistance).
- ALWAYS** use LEDs, transistors, the high frequency IC, the antenna, and switches in conjunction with other components that will limit the current through them. Failure to do so will create a short circuit and/or damage those parts.
- ALWAYS** connect the adjustable resistor so that if set to its 0 setting, the current will be limited by other components in the circuit.
- ALWAYS** connect position capacitors so that the "+" side gets the higher voltage.
- ALWAYS** disconnect your batteries immediately and check your wiring if something appears to be getting hot.
- ALWAYS** check your wiring before turning on a circuit.
- ALWAYS** connect ICs using configurations given in the projects or as per the connection descriptions for the parts.
- NEVER** try to use the high frequency IC as a transistor (the packages are similar, but the parts are different).
- NEVER** use the 2.5V lamp in a circuit with both battery holders unless you are sure that the voltage across it will be limited.
- NEVER** connect to an electrical outlet in your home in any way.
- NEVER** leave a circuit unattended when it is turned on.
- NEVER** touch the motor when it is spinning at high speed.

Note: If you have the more advanced Models Boffin 500 or Boffin 750, there are additional guidelines in your other project manual(s).

For all of the projects given in this book, the parts may be arranged in different ways without changing the circuit. For example, the order of parts connected in series or in parallel does not matter — what matters is how combinations of these sub-circuits are arranged together.

Warning to Boffin II Auto owners: Do not connect your parts to the Rover body except when using our approved circuits, the Rover body has a higher voltage which could damage your parts.

Examples of SHORT CIRCUITS - NEVER DO THESE!!!

Placing a 3-snap wire directly across the batteries is a SHORT CIRCUIT.

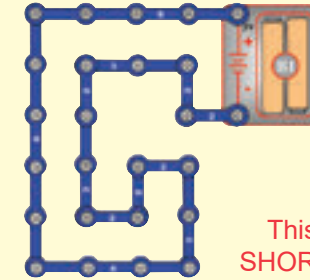
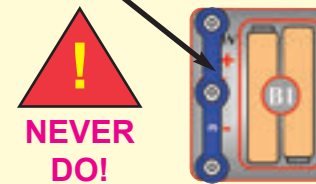

This is also a SHORT CIRCUIT.

When the slide switch (S1) is turned on, this large circuit has a SHORT CIRCUIT path (as shown by the arrows). The short circuit prevents any other portions of the circuit from ever working.

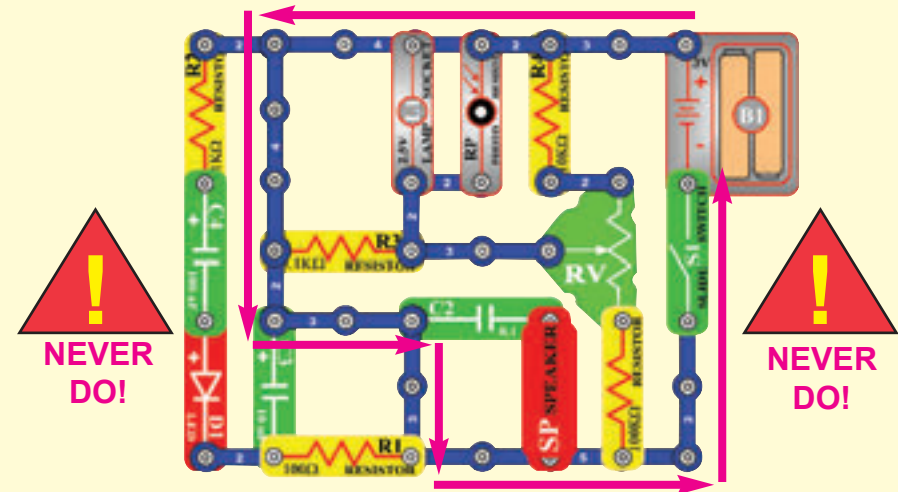

You are encouraged to tell us about new circuits you create. If they are unique, we will post them with your name and state on our website at www.snapcircuits.net/kidkreations.htm. Send your suggestions to ConQuest entertainment a.s.

ConQuest entertainment a.s. provides a circuit designer so that you can make your own Boffin drawings. This Microsoft® Word document can be downloaded from www.snapcircuits.net/SnapDesigner.doc or through the www.toy.cz web site.

WARNING: SHOCK HAZARD - Never connect Boffin to the electrical outlets in your home in any way!

MORE Advanced Troubleshooting (Adult supervision recommended)

ConQuest entertainment a.s. is not responsible for parts damaged due to incorrect wiring.

If you suspect you have damaged parts, you can follow this procedure to systematically determine which ones need replacing:

1. - 9. Refer to project manual 1 (projects 1-101) for testing steps 1-9, then continue below. Test both lamps (L1, L2) and battery holders in test step 1, all blue snap wires in step 3, and both LEDs (D1, D2) in step 5.

10. **1K Ω (R2), 5.1K Ω (R3), and 10K Ω (R4) resistors:** Build project #7 but use each of these resistors in place of the 100 Ω resistor (R1), the LED should light and the brightness decreases with the higher value resistors.

11. **Antenna (A1):** Build the mini-circuit shown here, you should hear sound.

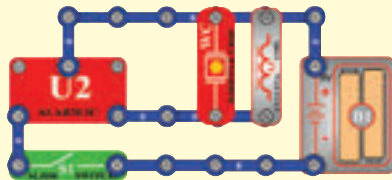

12. **NPN transistor (Q2):** Build the mini-circuit shown here. The LED (D2) should only be on if the press switch (S2) is pressed. If otherwise, then the NPN is damaged.

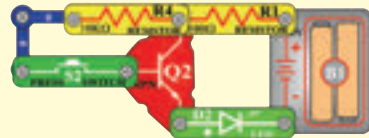

13. **PNP transistor (Q1):** Build the mini-circuit shown here. The LED (D1) should only be on if the press switch (S2) is pressed. If otherwise, then the PNP is damaged.

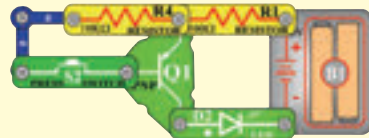

14. **Adjustable resistor (RV):** Build project #261 but use the 1K Ω resistor (R2) in place of the photoresistor (RP), the resistor control can turn the LED (D1) on and off.

15. **100 Ω K resistor (R5) and 0.02 μ F (C1), 0.1 μ F (C2), and 10 μ F (C3) capacitors:** Build project #206, it makes sound unless the resistor is bad. Place the 0.02 μ F capacitor on top of the whistle chip (WC) and the sound changes (pitch is lower). Replace the 0.02 μ F with the 0.1 μ F and the pitch is even lower. Replace the 0.1 μ F with the 10 μ F and the circuit will “click” about once a second.

16. **100 μ F (C4) and 470 μ F (C5) capacitors:** Build project #225, press the press switch (S2) and turn on the slide switch (S1). The LED (D1) should be lit for about 15 seconds then go out (press the press switch again to reset this). Replace the 470 μ F with the 100 μ F and the LED is only lit for about 4 seconds now.

17. **Power Amplifier IC (U4):** Build project #293, the sound from the speaker (SP) should be loud.

18. **Microphone (X1):** Build project #109, blowing into the microphone should turn off the lamp (L2).

19. **Variable Capacitor (CV):** Build project #213 and place it near an AM radio, tune the radio and the capacitor to verify you hear the music on your radio.

20. **High Frequency IC (U5):** Build project #242 and adjust the variable capacitor (CV) and adjustable resistor (RV) until you hear a radio station.

Note: If you have the more advanced Models Boffin 500 or Boffin 750

ConQuest entertainment a.s.

Hloubětínská 11, Praha 9, 198 00

Phone: +420 284 000 111

e-mail: info@toy.cz

Web site: www.toy.cz

You may order additional / replacement parts at:
www.toy.cz

Project Listings

Project #	Description	Page #	Project #	Description	Page #	Project #	Description	Page #
102	Batteries in Series	8	136	High Frequency Touch Buzzer	19	170	PNP Light Control	27
103	Batteries in Parallel	8	137	High Frequency Water Buzzer	19	171	PNP Dark Control	27
104	Spacey Fan	9	138	Mosquito	19	172	Red & Green Control	28
105	Two-Transistor Light Alarm	9	139	High Sensitivity Voice Doorbell	20	173	Current Controllers	28
106	Light-Controlled Alarm	9	140	Louder Doorbell	20	174	Current Equalizing	28
107	Automatic Street Lamp	10	141	Very Loud Doorbell	20	175	Battery Polarity Tester	28
108	Voice-Controlled Rays of Light	10	142	Doorbell with Button	20	176	Blow Off a Doorbell	29
109	Blowing Off the Electric Light	10	143	Darkness Announcer	20	177	Blow Off a Candle	29
110	Adjustable Tone Generator	11	144	Musical Motion Detector	20	178	Blow On a Doorbell	29
111	Photosensitive Electronic Organ	11	145	Radio Music Alarm	21	179	Blow On a Candle	29
112	Electronic Cicada	11	146	Daylight Music Radio	21	180	Screaming Fan	30
113	Light & Sounds	12	147	Night Music Radio	21	181	Whining Fan	30
114	More Light & Sounds	12	148	Night Gun Radio	21	182	Light Whining	30
115	More Light & Sounds (II)	12	149	Radio Gun Alarm	21	183	More Light Whining	30
116	More Light & Sounds (III)	12	150	Daylight Gun Radio	21	184	Motor Than Won't Start	30
117	More Light & Sounds (IV)	12	151	Blow Off a Space War	22	185	Whiner	31
118	Motor Speed Detector	13	152	Series Lamps	22	186	Lower Pitch Whiner	31
119	Old-Style Typewriter	13	153	Parallel Lamps	22	187	Hummer	31
120	Space War Sounds	14	154	Fire Fan Symphony	23	188	Adjustable Metronome	31
121	Space War Sounds Controlled by Light	14	155	Fire Fan Symphony (II)	23	189	Quiet Flasher	31
122	Space War Radio	15	156	Fan Symphony	23	190	Hissing Foghorn	32
123	The Lie Detector	15	157	Fan Symphony (II)	23	191	Hissing & Clicking	32
124	NPN Amplifier	16	158	Police Car Symphony	24	192	Video Game Engine Sound	32
125	PNP Amplifier	16	159	Police Car Symphony (II)	24	193	Light Alarm	33
126	Sucking Fan	17	160	Ambulance Symphony	24	194	Brighter Light Alarm	33
127	Blowing Fan	17	161	Ambulance Symphony (II)	24	195	Lazy Fan	33
128	PNP Collector	17	162	Static Symphony	25	196	Laser Light	33
129	PNP Emitter	17	163	Static Symphony (II)	25	197	Water Alarm	34
130	NPN Collector	18	164	Capacitors in Series	25	198	Radio Announcer	34
131	NPN Emitter	18	165	Capacitors in Parallel	25	199	Pitch	35
132	NPN Collector - Motor	18	166	Water Detector	26	200	Pitch (II)	35
133	NPN Emitter - Motor	18	167	Salt Water Detector	26	201	Pitch (III)	35
134	Buzzing in the Dark	19	168	NPN Light Control	27	202	Flooding Alarm	35
135	Touch Buzzer	19	169	NPN Dark Control	27	203	Make Your Own Battery	36

Project Listings

Project #	Description	Page #	Project #	Description	Page #	Project #	Description	Page #
204	Make Your Own Battery (II)	36	238	Trombone	48	272	Photoresistor Control	61
205	Make Your Own Battery (III)	36	239	Race Car Engine	48	273	Microphone Control	61
206	Tone Generator	37	240	Power Amplifier	49	274	Pressure Alarm	62
207	Tone Generator (II)	37	241	Feedback Kazoo	49	275	Power Microphone	62
208	Tone Generator (III)	37	242	AM Radio	50	276	LED Fan Rotation Indicator	63
209	Tone Generator (IV)	37	243	Fire Engine Symphony	51	277	Space War Sounds with LED	63
210	More Tone Generator	38	244	Fire Engine Symphony (II)	51	278	Sound Mixer	64
211	More Tone Generator (II)	38	245	Vibration or Sound Indicator	51	279	Sound Mixer Fan Driver	64
212	More Tone Generator (III)	38	246	Two-Finger Touch Lamp	52	280	Electric Fan Stopped by Light	65
213	Music Radio Station	39	247	One-Finger Touch Lamp	52	281	Motor & Lamp	65
214	Alarm Radio Station	39	248	Space Battle	53	282	Start-Stop Delay	66
215	Standard Transistor Circuit	39	249	Space Battle (II)	53	283	Mail Notifying System	66
216	Motor & Lamp by Sound	40	250	Multi-Speed Light Fan	53	284	Mail Notifying Electronic Bell	67
217	Fading Siren	40	251	Light & Finger Light	53	285	Mail Notifying Electronic Lamp	67
218	Fast Fade Siren	40	252	Storing Electricity	54	286	Twice-Amplified Oscillator	67
219	Laser Gun with Limited Shots	41	253	Lamp Brightness Control	54	287	Quick Flicking LED	67
220	Symphony of Sounds	41	254	Electric Fan	54	288	AM Radio with Transistors	68
221	Symphony of Sounds (II)	41	255	Radio Music Burglar Alarm	55	289	AM Radio (II)	68
222	Transistor Amplifiers	42	256	Light Dimmer	55	290	Music Amplifier	69
223	Pressure Meter	42	257	Motion Detector	56	291	Delayed Action Lamp	69
224	Resistance Meter	42	258	Fan Modulator	56	292	Delayed Action Fan	69
225	Auto-Off Night-Light	43	259	Oscillator 0.5 - 30Hz	57	293	Police Siren Amplifier	70
226	Discharging Caps	43	260	Sound Pulse Oscillator	57	294	Lasting Doorbell	70
227	Changing Delay Time	43	261	Motion Detector (II)	57	295	Lasting Clicking	70
228	Morse Code Generator	44	262	Motor Rotation	58	296	Leaky Capacitor	71
229	LED Code Teacher	44	263	Motor Delay Fan	58	297	Transistor Fading Siren	71
230	Ghost Shriek Machine	44	264	Motor Delay Fan (II)	58	298	Fading Doorbell	71
231	LED & Speaker	44	265	High Pitch Bell	59	299	Blowing Space War Sounds	72
232	Dog Whistle	44	266	Steamboat Whistle	59	300	Adjustable Time Delay Lamp	72
233	Mind Reading Game	45	267	Steamship	59	301	Adjustable Time Delay Fan	72
234	Enhanced Quiet Zone Game	46	268	Steamship Horn	59	302	Adjustable Time Delay Lamp (II)	73
235	Capacitor Charge & Discharge	46	269	Noise-Activated Burglar Alarm	60	303	Adjustable Time Delay Fan (II)	73
236	Sound Wave Magic	47	270	Motor-Activated Burglar Alarm	60	304	Watch Light	73
237	Space War Amplifier	47	271	Light-Activated Burglar Alarm	60	305	Delayed Bedside Fan	73



Project #102

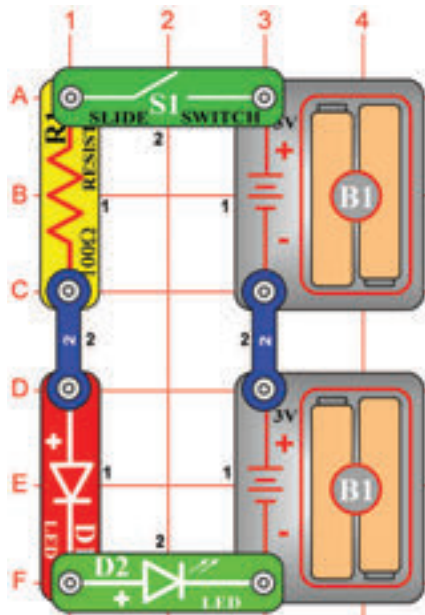

Batteries in Series

OBJECTIVE: To show the increase in voltage when batteries are connected in series.

When you turn on the slide switch (S1), current flows from the batteries through the slide switch, the 100Ω resistor (R1), the LED (D1), through the LED (D2), and back to the second group of batteries (B1). Notice how both LED's are lit. The voltage is high enough to turn on both LED's when the batteries are connected in series. If only one set of batteries is used, the LED's will not light up.

Some devices use only one 1.5 volt battery, but they make hundreds of volts electronically from this small source. A flash camera is an example of this.



Project #103

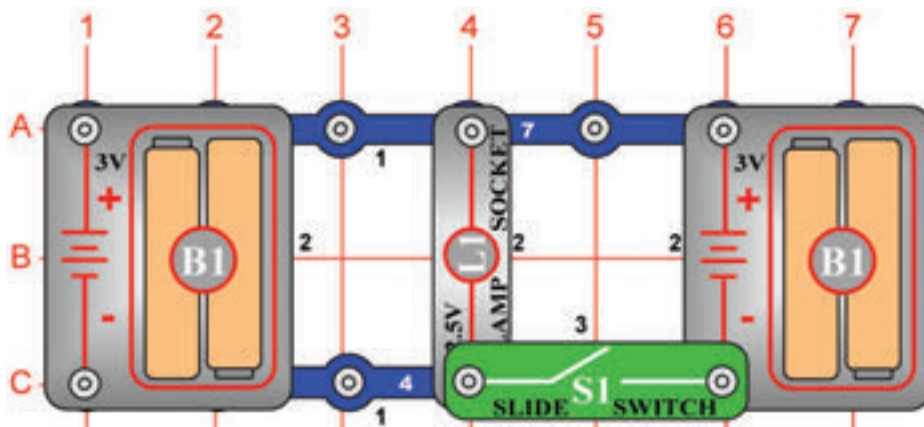

Batteries in Parallel

OBJECTIVE: To show how batteries in parallel are used to increase current.

Build the circuit shown on the left by placing all the parts with a black 1 next to them on the board first (including the 1-snap wire at base grid location C6). Then, assemble the parts marked with a 2. Finally, place the slide switch (S1) on top as shown. Leave the switch in the off position.

The light should be on and the brightness of the lamp (L1) will depend on the quality of the batteries in the holder (B1) on the left. Put weak batteries in the left holder and strong batteries in the right holder. Now turn on the switch. The lamp will get brighter as the fresh batteries take over and supply the current to the light.

Batteries are placed in parallel when the voltage is high enough but the circuit needs more current than one group of batteries can supply.

Think of each battery as a storage tank that supplies water. If you put two in parallel, you can get more water (current), but the pressure (voltage) stays the same.

Project #104 Spacey Fan

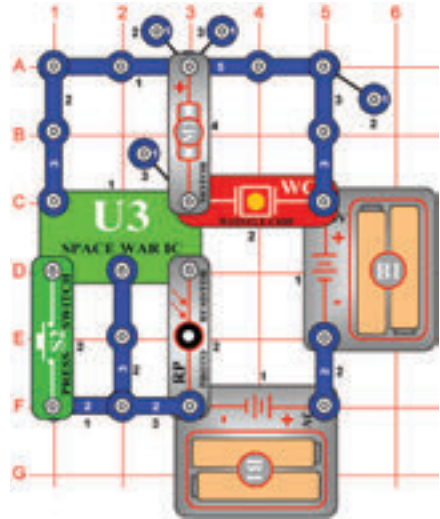

OBJECTIVE: To build a fan with space war sounds that is activated by light.

Place the fan onto the motor (M1). Space war sounds are heard if light shines on the photoresistor (RP) OR if you press the press switch (S2), the fan may start to spin, but will only get to high speed if you do BOTH. Try various combinations of shining light and holding down the press switch.



WARNING: Moving parts. Do not touch the fan or motor during operation.

Project #105 Two-Transistor Light Alarm

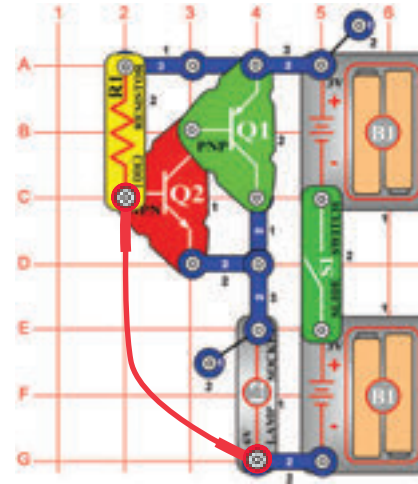

OBJECTIVE: To compare transistor circuits.

This light alarm circuit uses two transistors (Q1 & Q2) and both sets of batteries. Build the circuit with the jumper connected as shown, and turn it on. Nothing happens. Break the jumper connection and the lamp (L2) turns on. You could replace the jumper with a longer wire and run it across a doorway to signal an alarm when someone enters.

Project #106 Light-controlled Alarm

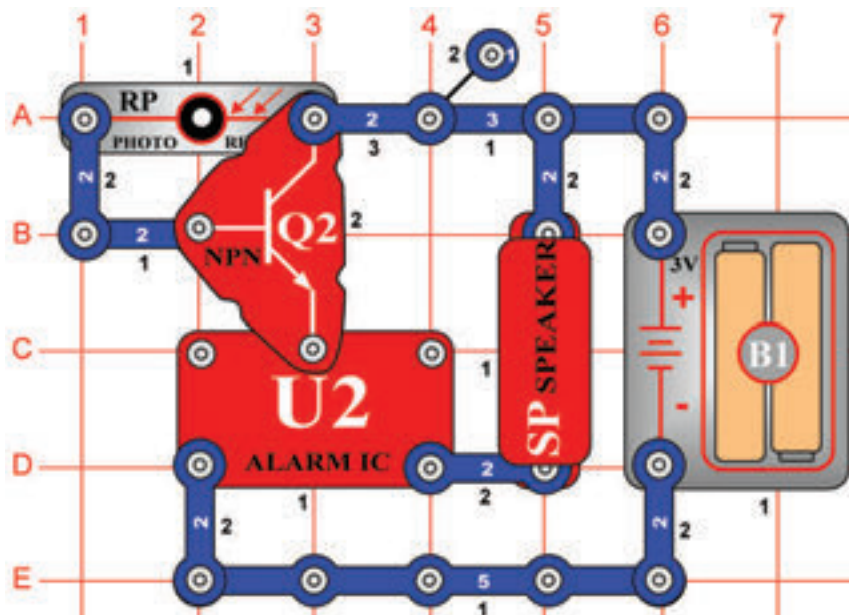

Light-controlled Alarm

OBJECTIVE: To show how light is used to turn an alarm.

The alarm will sound, as long as light is present. Slowly cover the photoresistor (RP), and the volume goes down. If you turn off the lights, the alarm will stop. The amount of light changes the resistance of the photoresistor (less light means more resistance). The photoresistor and transistor (Q2) act like a dimmer switch, adjusting the voltage applied to the alarm.

This type of circuit is used in alarm systems to detect light. If an intruder turned on a light or hit the sensor with a flashlight beam, the alarm would trigger and probably force the intruder to leave.



Project #107

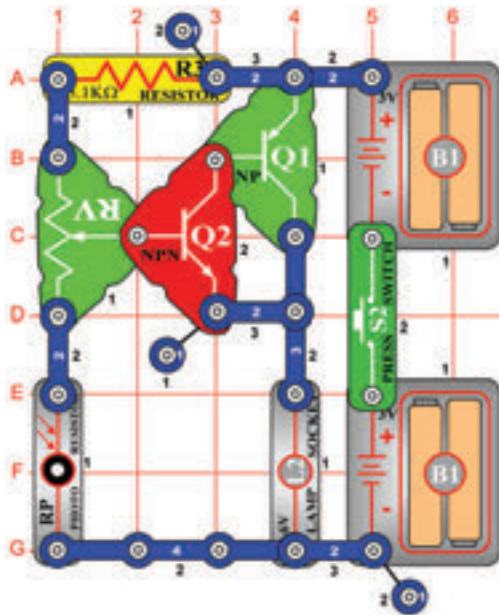

Automatic Street Lamp

OBJECTIVE: To show how light is used to control a street lamp.

Press the press switch (S2) on and set the adjustable resistor (RV) so the lamp (L2) just lights. Slowly cover the photoresistor (RP) and the lamp brightens. If you place more light at the photoresistor the light dims.

This is an automatic street lamp that you can turn on by a certain darkness and turn off by a certain brightness. This type of circuit is installed on many outside lights and forces them to turn off and save electricity. They also come on when needed for safety.



Project #108

Voice-controlled Rays of Light

OBJECTIVE: To show how light is stimulated by sound.

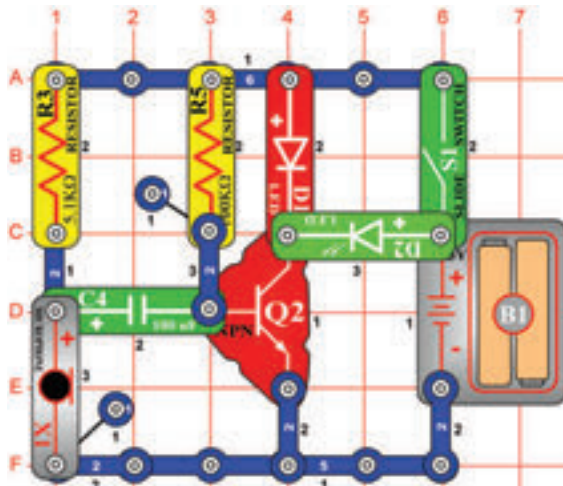

Turn the slide switch (S1) on. There will be only a weak light emitting from the green LED (D2). By blowing on the mic (X1) or putting it near a radio or TV set, the green LED will emit light, and its brightness changes as the loudness changes.



Project #109

Blowing Off the Electric Light

OBJECTIVE: To show how light is stimulated by sound.

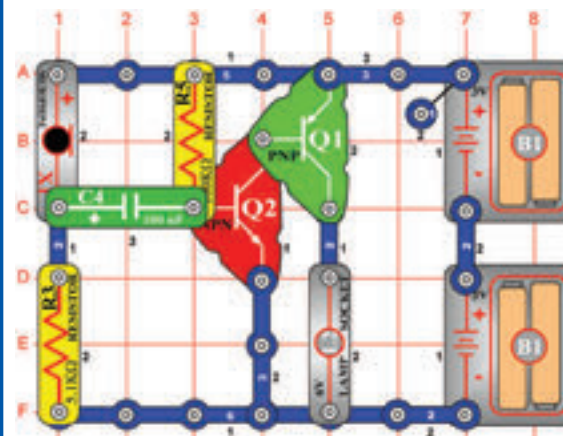

Install the parts. The lamp (L2) will be on. It will be off as long as you blow on the mic (X1). Speaking loud into the mic will change the brightness of the lamp.



Project #110

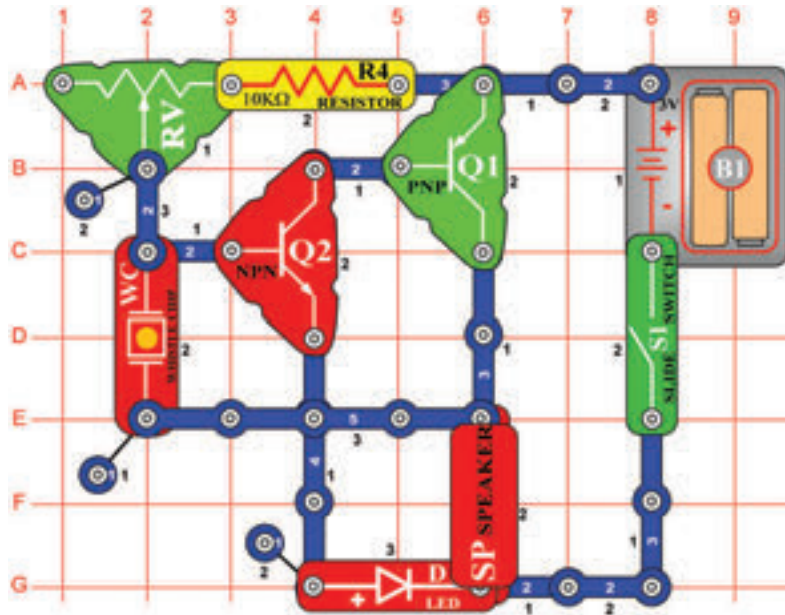

Adjustable Tone Generator

OBJECTIVE: To show how resistor values change the frequency of an oscillator.

Turn on the slide switch (S1); the speaker (SP) will sound and the LED (D1) will light. Adjust the adjustable resistor (RV) to make different tones. In an oscillator circuit, changing the values of resistors or capacitors can vary the output tone or pitch.



Project #111 Photosensitive Electronic Organ

OBJECTIVE: To show how resistor values change the frequency of an oscillator.

Use the circuit from project #110 shown above. Replace the 10kΩ resistor (R4) with the photoresistor (RP). Turn on the slide switch (S1). The speaker (SP) will sound and the LED (D1) will light. Move your hand up and down over the photoresistor and the frequency changes. Decreasing the light on the photoresistor increases the resistance and causes the circuit to oscillate at a lower frequency. Notice that the LED flashes also at the same frequency as the sound.

By using your finger, see if you can vary the sounds enough to make this circuit sound like an organ playing.



Project #112 Electronic Cicada

OBJECTIVE: To show how capacitors in parallel change the frequency of an oscillator.

Use the circuit from project #110 shown above, replace the photoresistor (RP) back to the 10kΩ resistor (R4). Place the 0.02μF capacitor (C1) on top of the whistle chip (WC). Place the slide switch (S1) on and adjust the adjustable resistor (RV). The circuit produces the sound of the cicada insect. By placing the 0.02μF capacitor on top of the whistle chip, the circuit oscillates at a lower frequency. Notice that the LED (D1) flashes also at the same frequency.

It is possible to pick resistors and capacitors that will make the pitch higher than humans can hear. Many animals, however, can hear these tones. For example, a parakeet can hear tones up to 50,000 cycles per second, but a human can only hear to 20,000.



Project #118

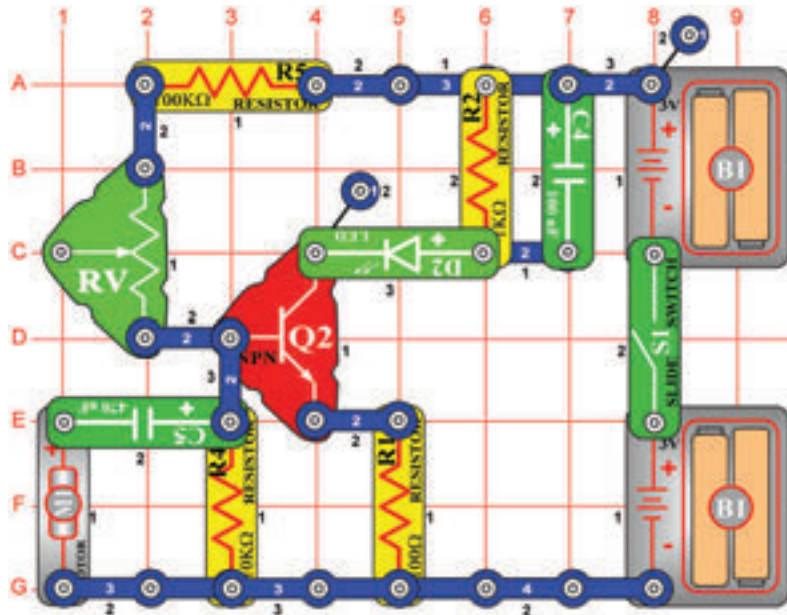

Motor Speed Detector

OBJECTIVE: To show how to make electricity in one direction.

When building the circuit, be sure to position the motor (M1) with the positive (+) side snapped to the 470µF capacitor (C5). Turn on the slide switch (S1), nothing will happen. It is a motor speed detector, and the motor isn't moving. Watch the LED (D2) and give the motor a good spin CLOCKWISE with your fingers (don't use the fan blade); you should see a flash of light. The faster you spin the motor, the brighter the flash will be. As a game, see who can make the brightest flash.

Now try spinning the motor in the opposite direction (counter-clockwise) and see how bright the flash is — it won't flash at all because the electricity it produces, flows in the wrong direction and won't activate the diode. Flip the motor around (positive (+) side snapped to the 3-snap wire) and try again. Now the LED lights only if you spin the motor counter-clockwise.



Project #119

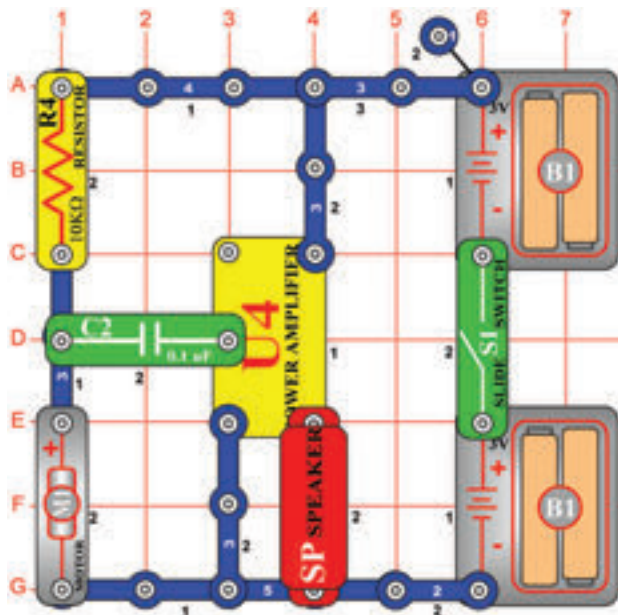

Old-Style Typewriter

OBJECTIVE: To show how a generator works.

Turn on the slide switch (S1), nothing will happen. Turn the motor (M1) slowly with your fingers (don't use the fan blade), you will hear a clicking that sounds like an old-time manual typewriter keystrokes. Spin the motor faster and the clicking speeds up accordingly.

This circuit works the same if you spin the motor in either direction (unlike the Motor Speed Detector project).

By spinning the motor with your fingers, the physical effort you exert is converted into electricity. In electric power plants, steam is used to spin large motors like this, and the electricity produced is used to run everything in your town.



Project #120

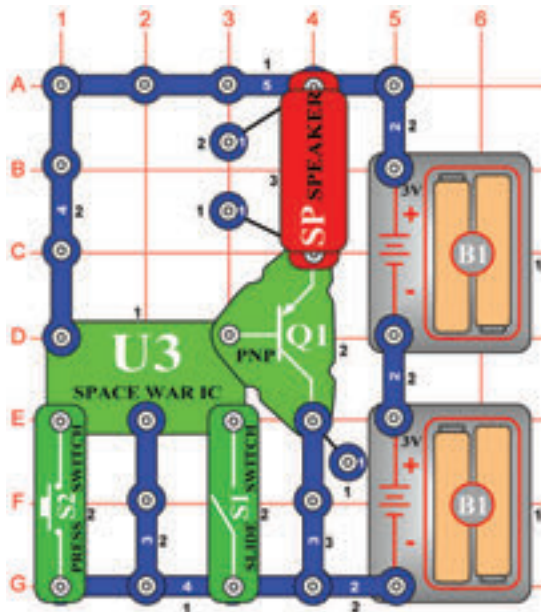

Space War Sounds

OBJECTIVE: To build a circuit that produces multiple space war sounds.

Set the slide switch (S1) to the OFF position. Press the press switch (S2) down and a space sound will be played. If you hold the press switch down the sound repeats. Press the press switch again and a different sound is played. Keep pressing the press switch to hear all the different sounds.

Next, set the slide switch to ON position. One of the sounds will be played continuously. Turn the switch off and then back on. A different sound is played. Keep pressing the press switch to hear all the different combinations of sounds.

The space war IC (U3) has “logic” built into its circuitry that allows it to switch between many different sounds.



Project #121

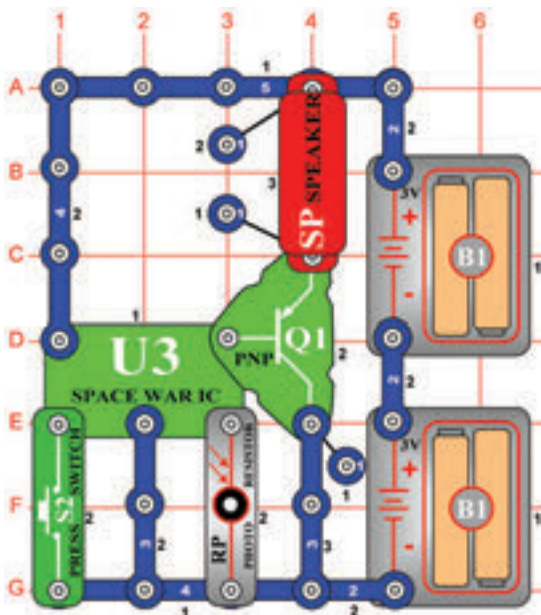

Space War Sounds Controlled By Light

OBJECTIVE: To change the sounds of a multiple space war with light.

Modify the preceding circuit to look like the one shown on the left.

The space war IC (U3) will play a sound continuously. Block the light to the photoresistor (RP) with your hand. The sound will stop. Remove your hand and a different sound is played. Wave your hand over the photoresistor to hear all the different sounds.

Press the press switch down and now two space war sounds are played. If you hold the press switch down the sound repeats. Press the press switch again and a different sound is played. Keep pressing the press switch to hear all the different combinations of sounds.



Project #122

Space War Radio

OBJECTIVE: To transmit Space War sounds to a AM radio.

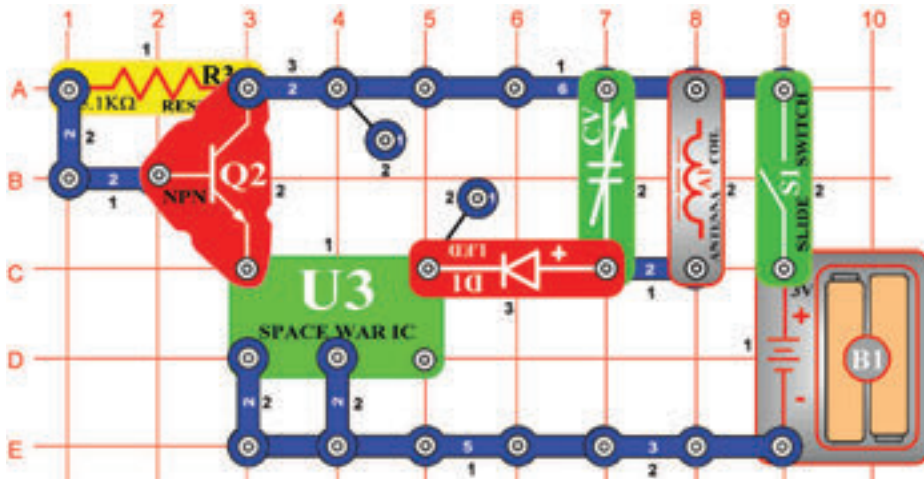

Place the circuit next to an AM radio. Tune the radio so no stations are heard and turn on the slide switch (S1). You should hear the space war sounds on the radio. The red LED (D1) should also be lit. Adjust the variable capacitor (CV) for the loudest signal.

You have just performed the experiment that took Marconi (who invented the radio) a lifetime to invent. The technology of radio transmission has expanded to the point that we take it for granted. There was a time, however, when news was only spread by word of mouth.



Project #123

The Lie Detector

OBJECTIVE: To show how sweat makes a better conductor.

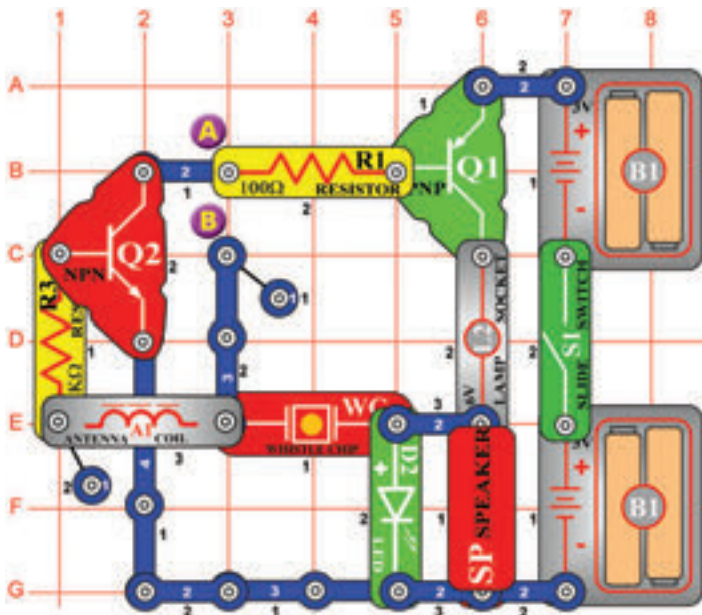

Turn on the slide switch (S1) and place your finger across points A & B. The speaker (SP) will output a tone and the LED (D2) will flash at the same frequency. Your finger acts as a conductor connecting points A & B. When a person is lying, one thing the body starts to do is sweat. The sweat makes the finger a better conductor by reducing its resistance.

As the resistance drops, the frequency of the tone increases. Lightly wet your finger and place it across the two points again. Both the output tone and LED flashing frequency increase, and the lamp (L2) may begin to light. If your finger is wet enough, then the lamp will be bright and the sound stops - indicating you are a big liar! Now change the wetness of your finger by drying it and see how it affects the circuit.

This is the same principle used in lie detectors that are sold commercially.



Project #124

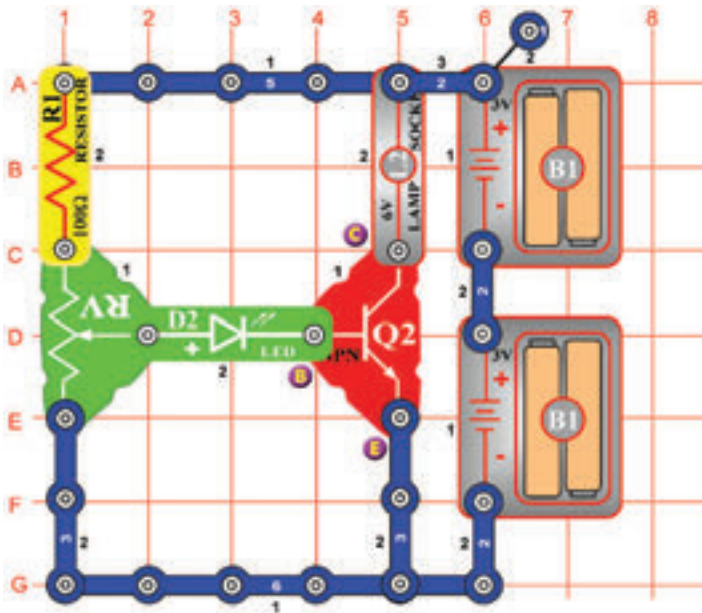

NPN Amplifier

OBJECTIVE: *To compare transistor circuits.*

There are three connection points on an NPN transistor (Q2), called base (marked B), emitter (marked E), and collector (marked C). When a small electric current flows from the base to the emitter, a larger (*amplified*) current will flow from the collector to the emitter. Build the circuit and slowly move up the adjustable resistor (RV) control. When the LED (D2) becomes bright, the lamp (L2) will also turn on and will be much brighter.



Project #125

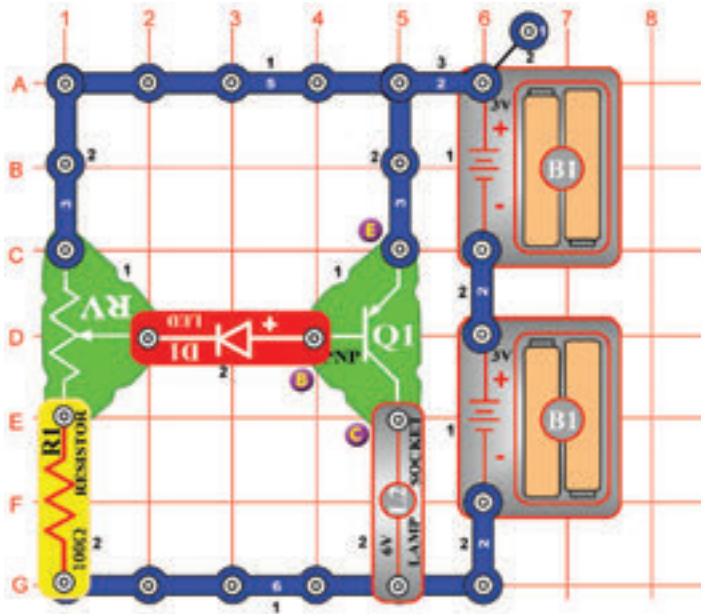

PNP Amplifier

OBJECTIVE: *To compare transistor circuits.*

The PNP transistor (Q1) is similar to the NPN transistor (Q2) in project #166, except that the electric currents flow in the opposite directions. When a small electric current flows from the emitter to the base, a larger (*amplified*) current will flow from the emitter to the collector. Build the circuit and slowly move up the adjustable resistor (RV) control. When the LED (D1) becomes bright, the lamp (L2) will also turn on and will be much brighter.

Project #126

Sucking Fan

Project #127 Blowing Fan

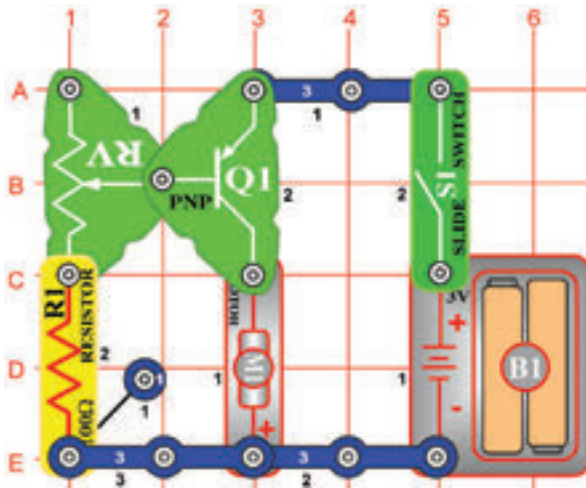

OBJECTIVE: To adjust the speed of a fan.

Build the circuit, and be sure to orient the motor (M1) with the positive (+) side down as shown. Turn it on, and set the adjustable resistor (RV) for the fan speed you like best. If you set the speed too fast then the fan may fly off the motor. Due to the shape of the fan blades and the direction the motor spins, air is sucked into the fan and towards the motor. Try holding a piece of paper just above the fan to prove this. If this suction is strong enough then it can lift the fan blades, just like in a helicopter.

The fan will not move on most settings of the resistor, because the resistance is too high to overcome friction in the motor. If the fan does not move at any resistor setting, then replace your batteries.

WARNING: Moving parts. Do not touch the fan or motor during operation.

WARNING: Do not lean over the motor.

OBJECTIVE: To build a fan that won't come off.

Modify the circuit from project #126 by reversing the position of the motor (M1), so the positive (+) side is towards the PNP (Q1). Turn it on, and set the adjustable resistor (RV) for the fan speed you like best. Set it for full speed and see if the fan flies off - it won't! The fan is blowing air upward now! Try holding a piece of paper just above the fan to prove this.

WARNING: Moving parts. Do not touch the fan or motor during operation.

Project #128 PNP Collector

Project #129 PNP Emitter

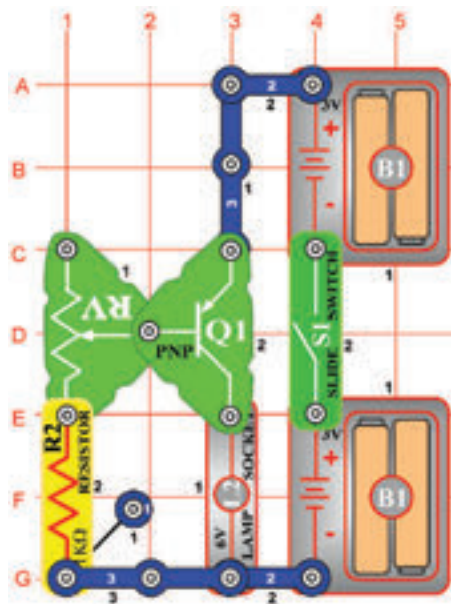

OBJECTIVE: To demonstrate adjusting the gain of a transistor circuit.

Build the circuit and vary the lamp (L2) brightness with the adjustable resistor (RV), it will be off for most of the resistor's range. The point on the PNP (Q1) that the lamp is connected to (point E4 on the base grid) is called the collector, hence the name for this project.

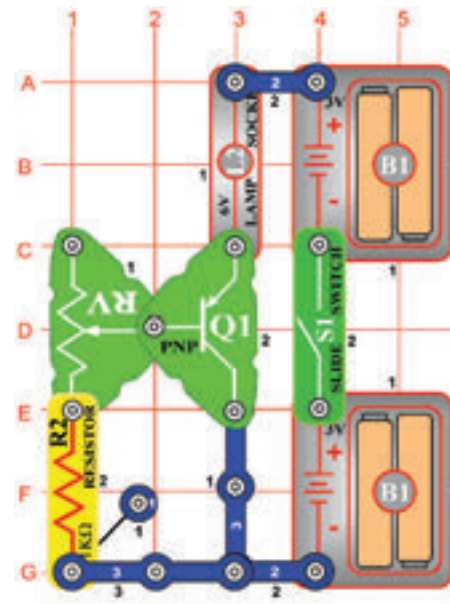

OBJECTIVE: To compare transistor circuits.

Compare this circuit to that in project #128. The maximum lamp (L2) brightness is less here because the lamp resistance reduces the emitter-base current, which contacts the emitter-collector current (as per project #128). The point on the PNP (Q1) that the lamp is now connected to (grid point C4) is called the emitter.

Project #130 NPN Collector

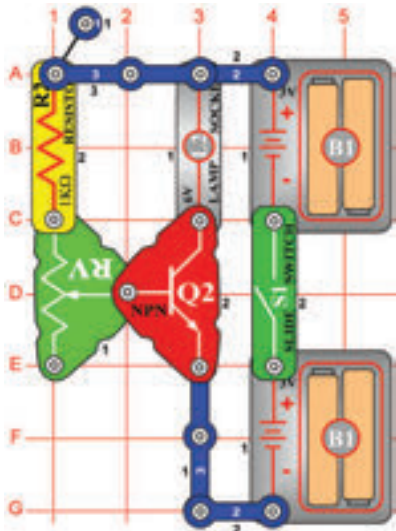

OBJECTIVE: To compare transistor circuits.

Compare this circuit to that in project #128, it is the NPN transistor (Q2) version and works the same way. Which circuit makes the lamp (L2) brighter? (They are about the same because both transistors are made from the same materials).

Project #131 NPN Emitter

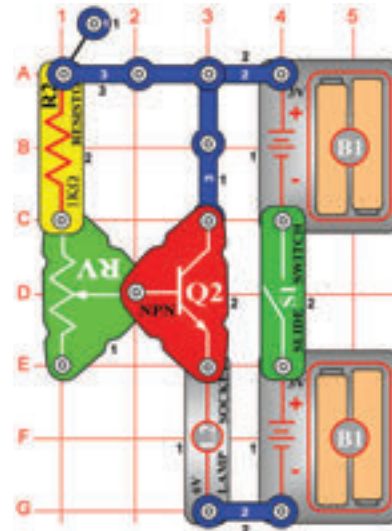

OBJECTIVE: To compare transistor circuits.

Compare this circuit to that in project #129. It is the NPN transistor (Q2) version and works the same way. The same principles apply here as in projects #128-#130, so you should expect it to be less bright than #130 but as bright as #129.

Project #132 NPN Collector - Motor

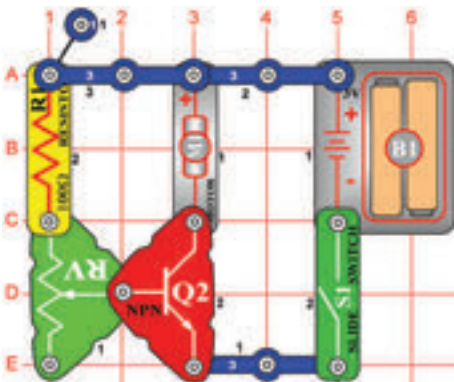

OBJECTIVE: To compare transistor circuits.

This is the same circuit as in project #130, except that it has the motor (M1) instead of the lamp. Place the motor with the positive (+) side touching the NPN and put the fan on it.

The fan will not move on most settings of the resistor, because the resistance is too high to overcome friction in the motor. If the fan does not move at any resistor setting, then replace your batteries.

WARNING: Moving parts. Do not touch the fan or motor during operation.

WARNING: Do not lean over the motor.

Project #133 NPN Emitter - Motor

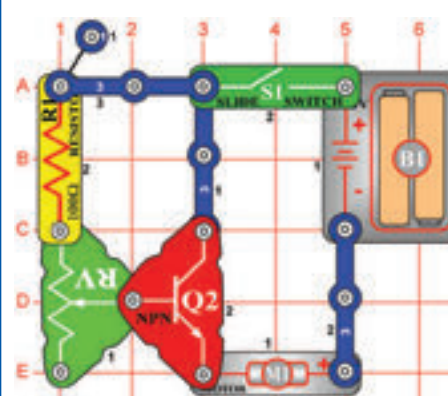

OBJECTIVE: To compare transistor circuits.

This is the same circuit as in project #131, except that it has the motor (M1) instead of the lamp. Place the motor with the positive (+) side to the right and put the fan on it. Compare the fan speed to that in project #132. Just as the lamp was dimmer in the emitter configuration, the motor is not as fast now.

WARNING: Moving parts. Do not touch the fan or motor during operation.

□ Project #134

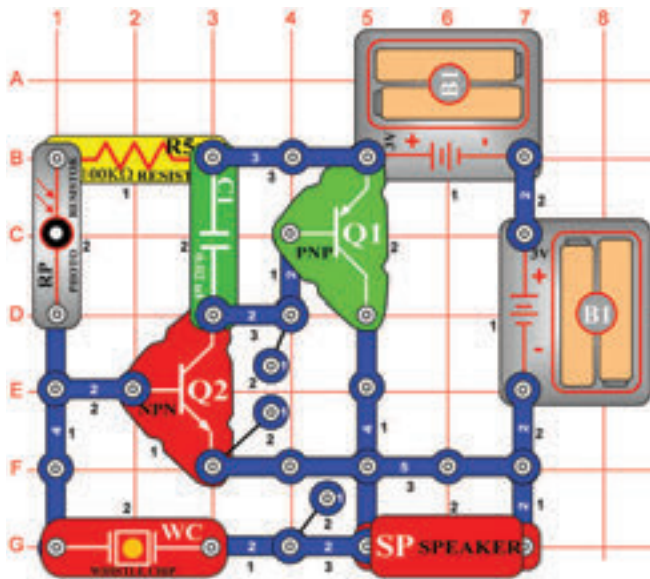

Buzzing in the Dark

OBJECTIVE: To make a circuit that buzzes when the lights are off.

This circuit makes a high-frequency screaming sound when light shines on the photoresistor (RP), and makes a buzzing sound when you shield the photoresistor.

□ Project #135

Touch Buzzer

OBJECTIVE: To build a human buzzer oscillator.

Remove the photoresistor (RP) from the circuit in project #134 and instead touch your fingers across where it used to be (points B1 and D1 on the grid) to hear a cute buzzing sound.

The circuit works because of the resistance in your body. If you put back the photoresistor and partially cover it, you should be able to make the same resistance your body did, and get the same sound.

□ Project #136

High Frequency Touch Buzzer

OBJECTIVE: To build a high frequency human buzzer oscillator.

Replace the speaker (SP) with the 6V lamp (L2). Now touching your fingers between B1 and D1 creates a quieter but more pleasant buzzing sound.

□ Project #137

High Frequency Water Buzzer

OBJECTIVE: To build a high frequency water buzzer oscillator.

Now connect two (2) jumpers to points B1 and D1 (that you were touching with your fingers) and place the loose ends into a cup of water. The sound will not be much different now, because your body is mostly water and so the circuit resistance has not changed much.

□ Project #138

Mosquito

OBJECTIVE: To make a buzz like a mosquito.

Place the photoresistor (RP) into the circuit in project #137 across where you were connecting the jumpers (points B1 and D1 on the grid, and as shown in project #134). Now the buzz sounds like a mosquito.

Project #139

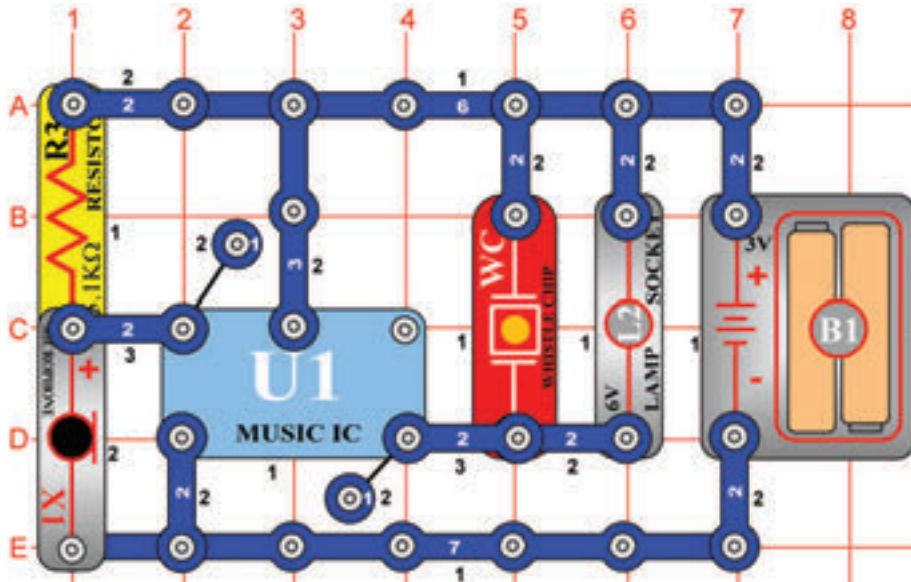

High Sensitivity Voice Doorbell

OBJECTIVE: To build a highly sensitive voice-activated doorbell.

Build the circuit and wait until the sound stops. Clap or talk loud a few feet away and the music plays again. The microphone (X1) is used here because it is very sensitive.

Project #140 Louder Doorbell

OBJECTIVE: To build a loud highly sensitive voice-activated doorbell.

Replace the 6V lamp (L2) with the antenna coil (A1), the sound is louder now.

Project #141 Very Loud Doorbell

OBJECTIVE: To build a very loud highly sensitive voice-activated doorbell.

Replace the antenna coil (A1) with the speaker (SP), the sound is much louder now.

Project #142 Doorbell with Button

OBJECTIVE: To build a press-activated doorbell.

Replace the microphone (X1) with the press switch (S2) and wait until the music stops. Now you have to press the slide switch (S1) to activate the music, just like the doorbell on your house.

Project #143 Darkness Announcer

OBJECTIVE: To play music when it gets dark.

Replace the press switch (S2) with the photoresistor (RP) and wait until the sound stops. If you cover the photoresistor now the music will play once, signaling that it has gotten dark. If the speaker (SP) is too loud then you may replace it with the antenna coil (A1).

Project #144 Musical Motion Detector

OBJECTIVE: To detect when someone spins the motor.

Replace the photoresistor (RP) with the motor (M1), oriented in either direction. Now spinning the motor will re-activate the music.

Project #145

Radio Music Alarm

OBJECTIVE: To build a radio music alarm.

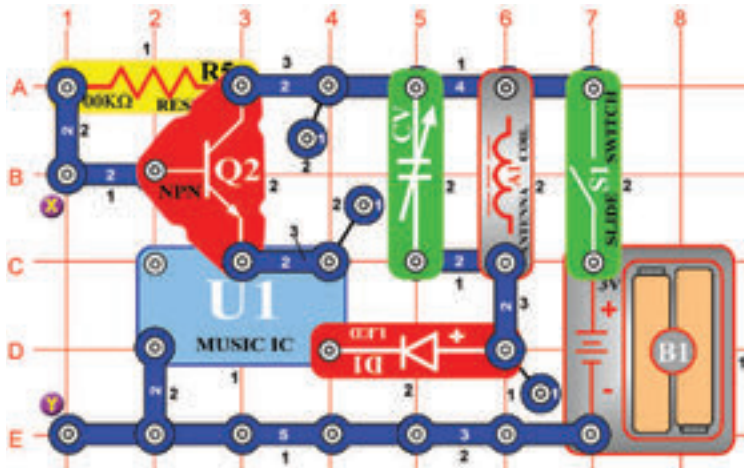

You need an AM radio for this project. Build the circuit on the left and turn on the slide switch (S1). Place it next to your AM radio and tune the radio frequency to where no other station is transmitting. Then, tune the adjustable capacitor (CV) until your music sounds best on the radio. Now connect a jumper wire between X and Y on the drawing, the music stops.

If you remove the jumper now, the music will play indicating your alarm wire has been triggered. You could use a longer wire and wrap it around a bike, and use it as a burglar alarm!

Project #146 Daylight Music Radio

OBJECTIVE: To build a light-controlled radio transmitter.

Remove the jumper wire. Replace the 100kΩ resistor (R5) with the photoresistor (RP). Now your AM radio will play music as long as there is light in the room.

Project #147 Night Music Radio

OBJECTIVE: To build a dark-controlled radio transmitter.

Put the 100kΩ resistor back in as before and instead connect the photoresistor between X & Y (you also need a 1-snap and a 2-snap wire to do this). Now your radio plays music when it is dark.

Project #148 Night Gun Radio

OBJECTIVE: To build a dark-controlled radio transmitter.

Replace the music IC (U1) with the alarm IC (U2). Now your radio plays the sound of a machine gun when it is dark.

Project #149 Radio Gun Alarm

OBJECTIVE: To build a radio alarm.

Remove the photoresistor (RP). Now connect a jumper wire between X & Y on the drawing. If you remove the jumper now, the machine gun sound will play on the radio indicating your alarm wire has been triggered.

Project #150 Daylight Gun Radio

OBJECTIVE: To build a light-controlled radio transmitter.

Remove the jumper wire. Replace the 100kΩ resistor (R5) with the photoresistor (RP). Now your AM radio will play the machine gun sound as long as there is light in the room.



Project #151

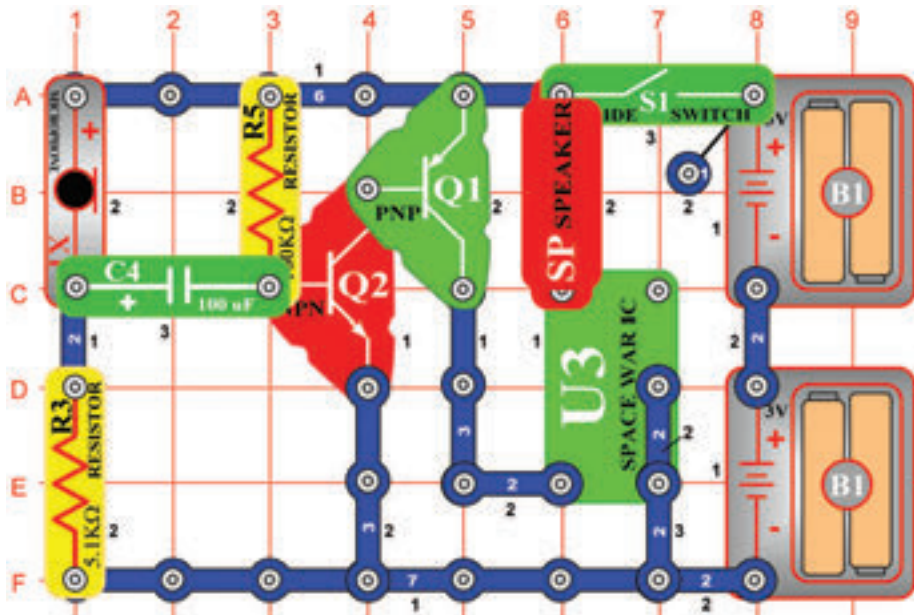

Blow Off a Space War

OBJECTIVE: To turn off a circuit by blowing on it.

Build the circuit and turn it on, you hear a space war. Since it is loud and annoying, try to shut it off by blowing into the microphone (X1). Blowing hard into the microphone stops the sound, and then it starts again.



Project #152 Series Lamps

OBJECTIVE: To compare types of circuits.

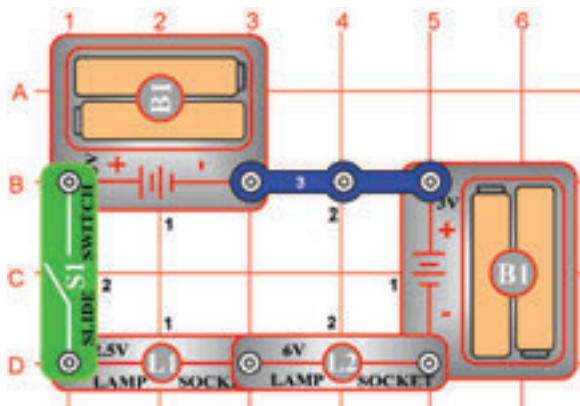

Turn on the slide switch (S1) and both lamps (L1 & L2) will light. If one of the bulbs is broken then neither will be on, because the lamps are in series. An example of this is the strings of small Christmas lights; if one bulb is damaged then the entire string does not work.



Project #153 Parallel Lamps

OBJECTIVE: To compare types of circuits.

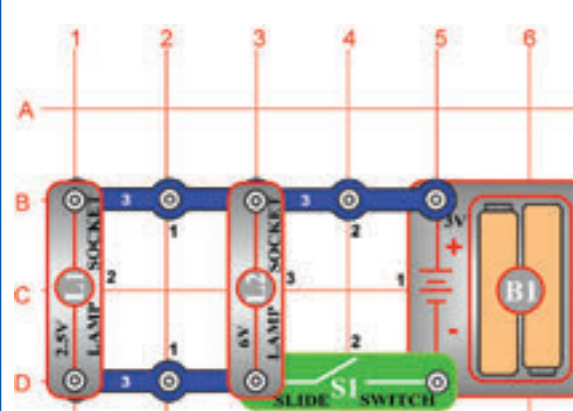

Turn on the slide switch (S1) and both lamps (L1 & L2) will light. If one of the bulbs is broken then the other will still be on, because the lamps are in parallel. An example of this is most of the lights in your house; if a bulb is broken on one lamp then the other lamps are not affected.

Project #154 Fire Fan Symphony

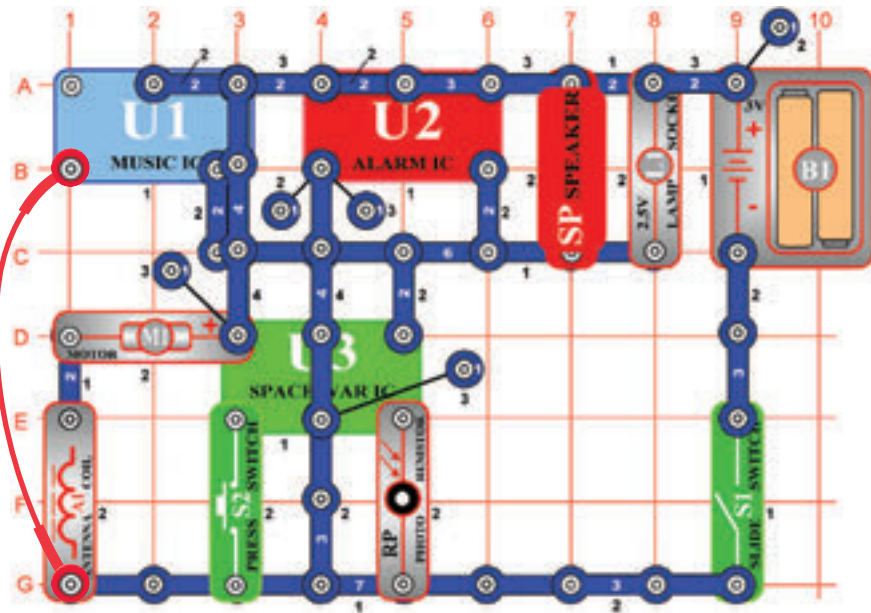

OBJECTIVE: To combine sounds from the music, alarm, and space war integrated circuits.

Build the circuit shown and add the jumper to complete it. Note that in one place two (2) single snaps are stacked on top of each other. Also, note that there is a 2-snap wire on layer 2 that does not connect with a 4-snap wire that runs over it on layer 4 (both touch the music IC). Turn it on and press the press switch (S2) several times and wave your hand over the photoresistor (RP) to hear the full spectrum of sounds that this circuit can create. Have fun!

WARNING: Moving parts. Do not touch the fan or motor during operation.

Project #155 Fire Fan Symphony (II)

OBJECTIVE: See project #154.

The preceding circuit may be too loud, so replace the speaker (SP) with the whistle chip (WC).

WARNING: Moving parts. Do not touch the fan or motor during operation.

Project #156 Fan Symphony

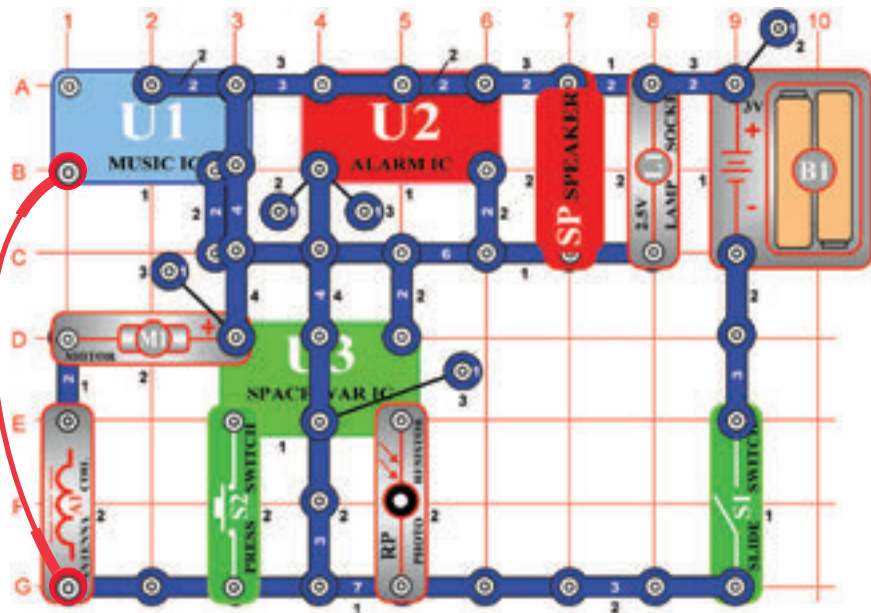

OBJECTIVE: To combine sounds from the music, alarm, and space war integrated circuits.

Modify the circuit from project #154 to match the circuit shown on the left. The only differences are the connections around the alarm IC (U2). It works the same way.

WARNING: Moving parts. Do not touch the fan or motor during operation.

Project #157 Fan Symphony (II)

OBJECTIVE: See project #156.

The preceding circuit may be too loud, so replace the speaker (SP) with the whistle chip (WC).

WARNING: Moving parts. Do not touch the fan or motor during operation.

Project #158 Police Car Symphony

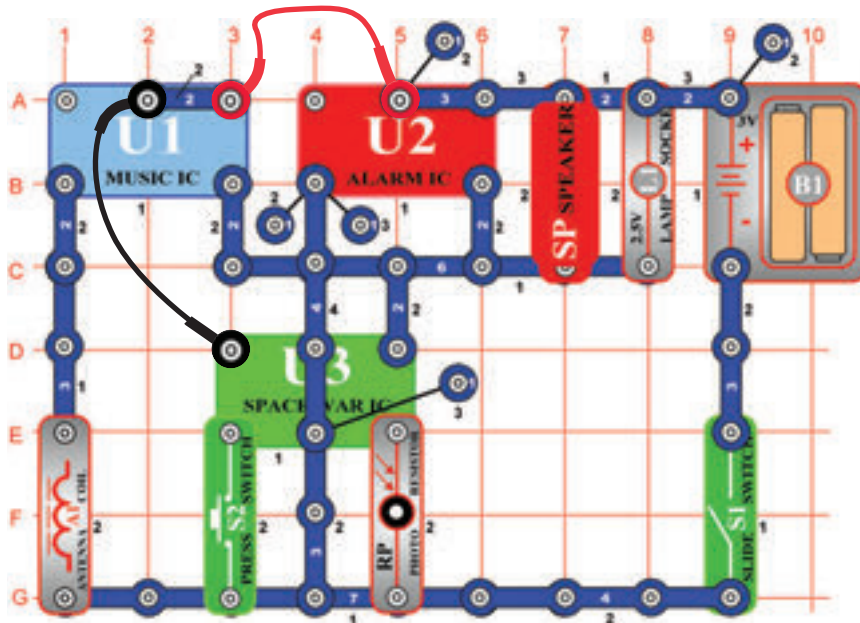

OBJECTIVE: To combine sounds from the integrated circuits.

Build the circuit shown and add the two (2) jumper wires to complete it. Note that in one place two (2) single snaps are stacked on top of each other. Turn it on and press the press switch (S2) several times and wave your hand over the photoresistor (RP) to hear the full spectrum of sounds that this circuit can create. Have fun!
Do you know why the antenna (A1) is used in this circuit? It is being used as just a 3-snap wire, because it acts like an ordinary wire in low frequency circuits such as this. Without it, you don't have enough parts to build this complex circuit.

Project #159 Police Car Symphony (II)

OBJECTIVE:
See project #158.

The preceding circuit may be too loud, so replace the speaker (SP) with the whistle chip (WC).

Project #160 Ambulance Symphony

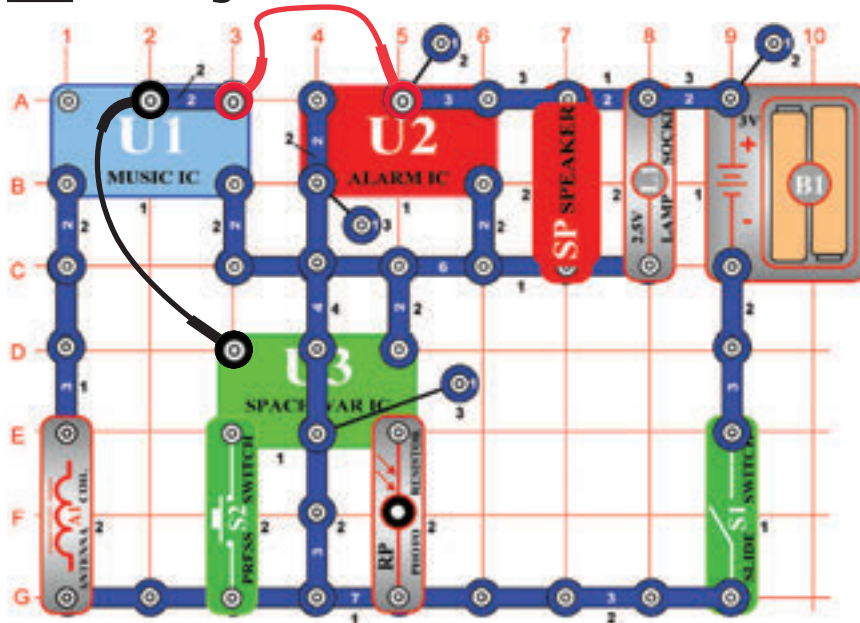

OBJECTIVE: To combine sounds from the music, alarm, and space war integrated circuits.

Modify the circuit from project #158 to match the circuit shown on the left. The only differences are the connections around the alarm IC (U2). It works the same way.

Project #161 Ambulance Symphony (II)

OBJECTIVE:
See project #160.

The preceding circuit may be too loud, so replace the speaker (SP) with the whistle chip (WC).

Project #162

Static Symphony

OBJECTIVE: To combine sounds from the integrated circuits.

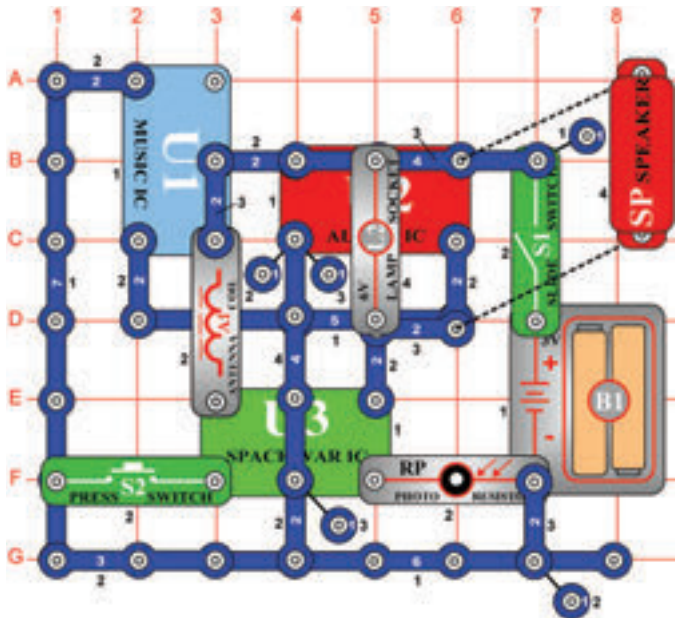

Build the circuit shown. Note that in some places parts are stacked on top of each other. Turn it on and press the press switch (S2) several times and wave your hand over the photoresistor (RP) to hear the full spectrum of sounds that this circuit can create. Have fun!

Project #163 Static Symphony (II)

OBJECTIVE:
See project #162.

For a variation on the preceding circuit, you can replace the 6V lamp (L2) with the LED (D1), with the positive (+) side up, or the motor (M1) (do not place the fan on it).

Project #164 Capacitors in Series

OBJECTIVE: To compare types of circuits.

Turn on the slide switch (S1), then press and release the press switch (S2). The LED (D1) becomes bright when the 470 μ F capacitor charges up with the press switch on, then the LED slowly gets dim after you release the press switch.

Now turn off the slide switch. Repeat the test with the slide switch off; you'll notice the LED goes out much faster after you release the press switch. The much smaller 100 μ F capacitor (C4) is now in series with the 470 μ F and so reduces the total capacitance (electrical storage capacity), and they discharge much faster. (Note that this is opposite to how resistors in series work).

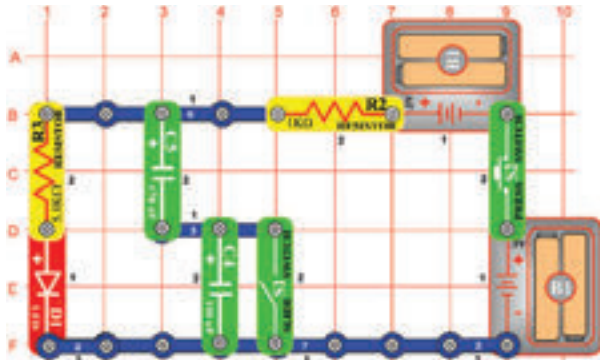

Project #165 Capacitors in Parallel

OBJECTIVE: To compare types of circuits.

Turn off the slide switch (S1), then press and release the press switch (S2). The LED (D1) becomes bright when the 100 μ F capacitor charges up with the press switch on, then the LED slowly gets dim after you release the press switch.

Now turn on the slide switch and repeat the test; you'll notice the LED goes out much slower after you release the press switch. The much larger 470 μ F capacitor (C5) is now in parallel with the 100 μ F and so increases the total capacitance (electrical storage capacity), and they discharge much slower. (Note that this is opposite to how resistors in parallel work.)

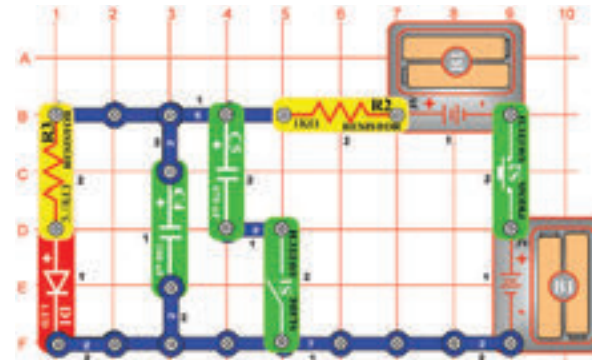



Project #166

Water Detector

OBJECTIVE: To show how water conducts electricity.

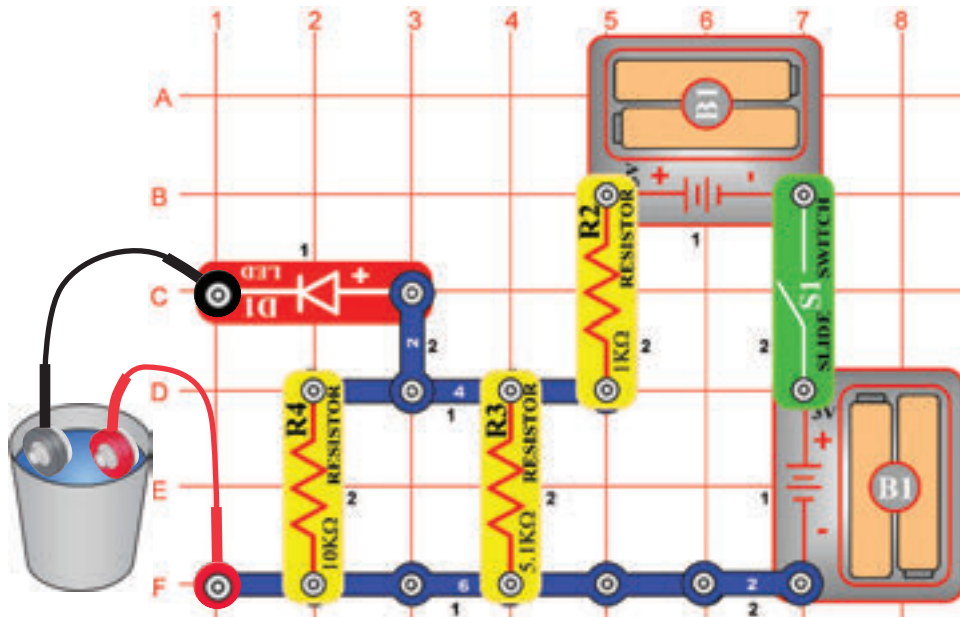

Build the circuit at left and connect the two jumpers to it, but leave the loose ends of the jumpers lying on the table initially. Turn on the slide switch (S1) - the LED (D1) will be dark because the air separating the jumpers has very high resistance. Touch the loose jumper ends to each other and the LED will be bright, because with a direct connection there is no resistance separating the jumpers.

Now take the loose ends of the jumpers and place them in a cup of water, without letting them touch each other. The LED should be dimly lit, indicating you have detected water!

For this experiment, your LED brightness may vary depending upon your local water supply. Pure water (like distilled water) has very high resistance, but drinking water has impurities mixed in that increase electrical conduction.



Project #167

Saltwater Detector

OBJECTIVE: To show how adding salt to water changes water's electrical characteristics.

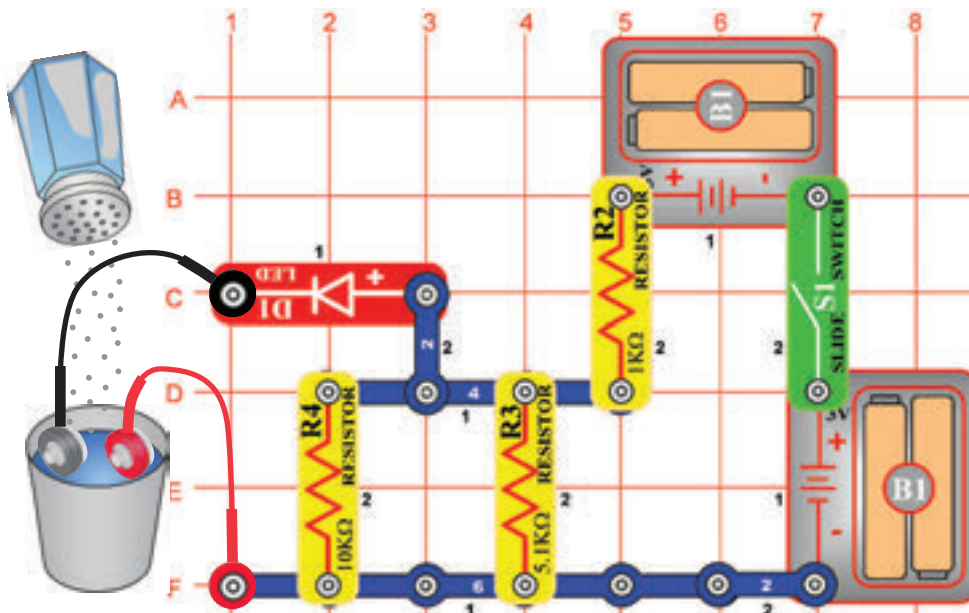

Place the jumpers in a cup of water as in the preceding project; the LED (D1) should be dimly lit. Slowly add salt to the water and see how the LED brightness changes, mix it a little so it dissolves. It will slowly become very bright as you add more salt. You can use this bright LED condition as a saltwater detector! You can then reduce the LED brightness by adding more water to dilute the salt.

Take another cup of water and try adding other household substances like sugar to see if they increase the LED brightness as the salt did.

Project #168 NPN Light Control

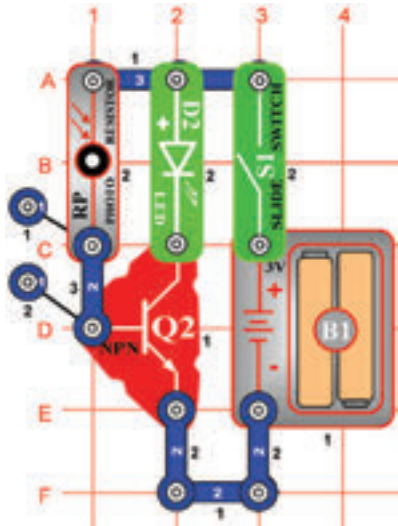

OBJECTIVE: To compare transistor circuits.

Turn on the slide switch (S1), the brightness of the LED (D2) depends on how much light shines on the photoresistor (RP). The resistance drops as more light shines, allowing more current to the NPN (Q2).

Project #169 NPN Dark Control

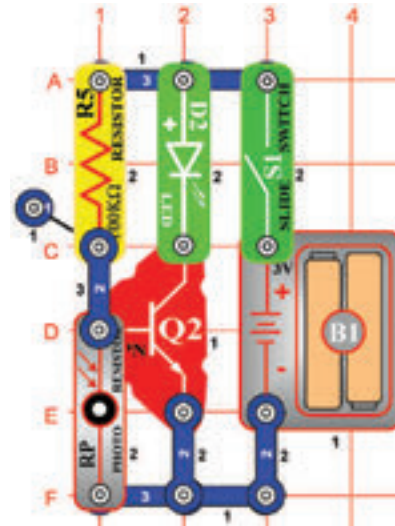

OBJECTIVE: To compare transistor circuits.

Turn on the slide switch (S1), the brightness of the LED (D2) depends on how LITTLE light shines on the photoresistor (RP). The resistance drops as more light shines, diverting current away from the NPN (Q2).

Project #170 PNP Light Control

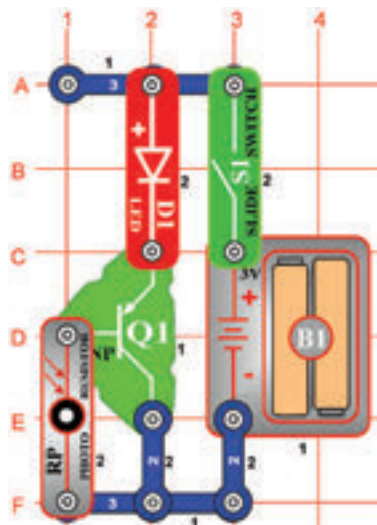

OBJECTIVE: To compare transistor circuits.

Turn on the slide switch (S1), the brightness of the LED (D1) depends on how much light shines on the photoresistor (RP). The resistance drops as more light shines, allowing more current through the PNP (Q1). This is similar to the NPN (Q2) circuit above.

Project #171 PNP Dark Control

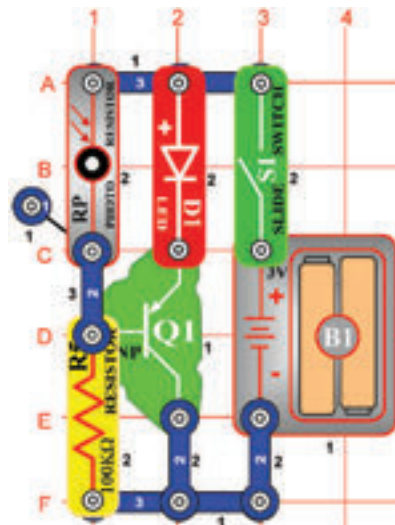

OBJECTIVE: To compare transistor circuits.

Turn on the slide switch (S1), the brightness of the LED (D1) depends on how LITTLE light shines on the photoresistor (RP). The resistance drops as more light shines, so more current gets to the 100kΩ resistor (R5) from the photoresistor path and less from the PNP-diode path. This is similar to the NPN circuit above.

Project #172

Red & Green Control

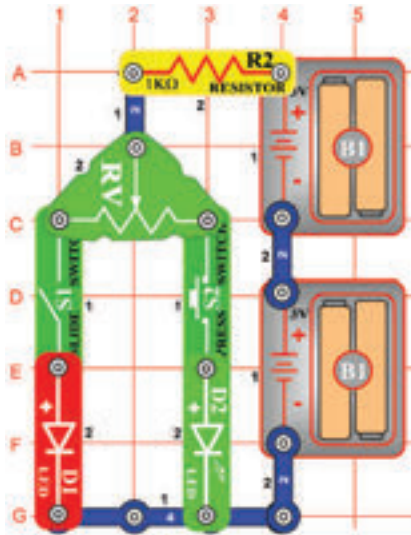

OBJECTIVE: To demonstrate how the adjustable resistor works.

Turn on the circuit using the slide switch (S1) and/or the press switch (S2) and move the adjustable resistor's (RV) control lever around to adjust the brightness of the LED's (D1 & D2). When the adjustable resistor is set to one side, that side will have low resistance and its LED will be bright (assuming the switch on that side is ON) while the other LED will be dim or OFF.

Project #173

Current Controllers

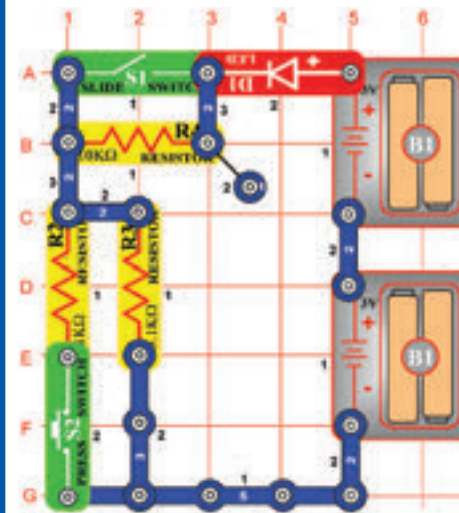

OBJECTIVE: To compare types of circuits.

Build the circuit and turn on the slide switch (S1), the LED (D1) will be lit. To increase the LED brightness, turn on the press switch (S2). To decrease the LED brightness, turn off the slide switch.

With the slide switch on, the 5.1kΩ resistor (R3) controls the current. Turning on the press switch places the 1kΩ resistor (R2) in parallel with it to decrease the total circuit resistance. Turning off the slide switch places the 10kΩ resistor (R4) in series with R2/R3 to increase the total resistance.

Project #174

Current Equalizing

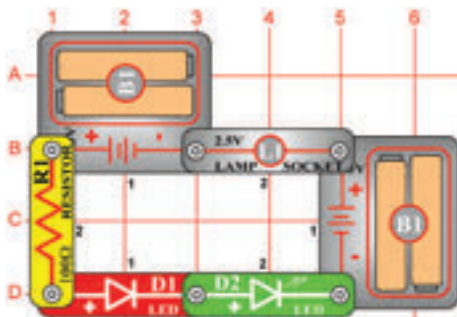

OBJECTIVE: To compare types of circuits.

In this circuit the LED's (D1 & D2) will have the same brightness, but the lamp (L1) will be off. When connected in series, all components will have equal electric current through them. The lamp is off because it requires a higher current through the circuit to turn on than the LED's do.

Project #175

Battery Polarity Tester

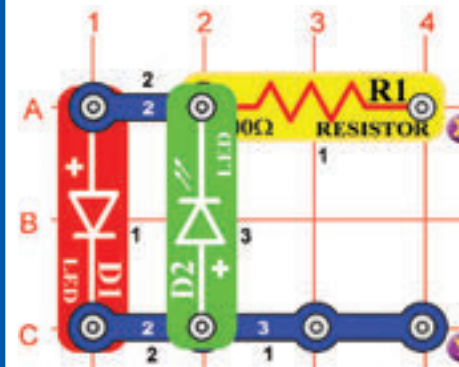

OBJECTIVE: To test the polarity of a battery.

Use this circuit to check the polarity of a battery. Connect your battery to X & Y on the drawing using the jumper cables (your 3V battery pack (B1) can also be snapped on directly instead). If the positive (+) side of your battery is connected to X, then the red LED (D1) will be on, if the negative (-) side is connected to X then the green LED (D2) will be on.

Project #176 Blow Off a Doorbell

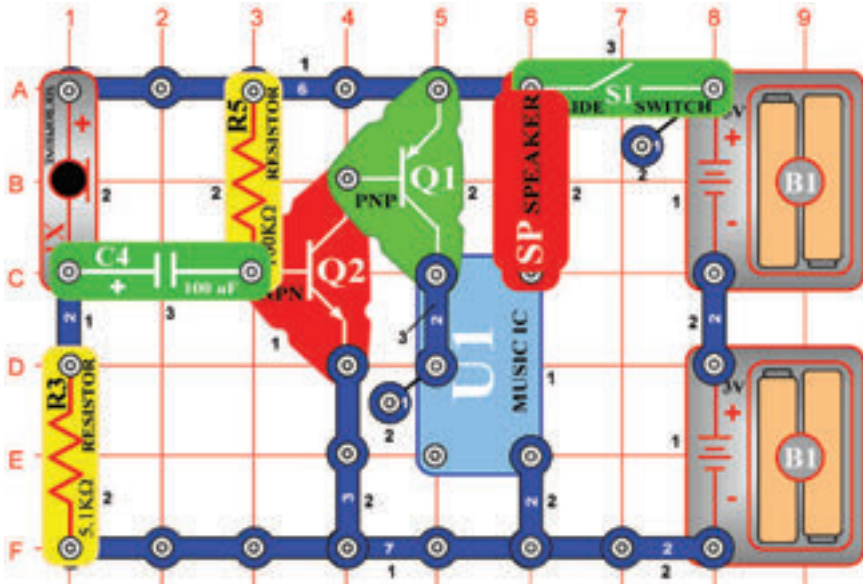

OBJECTIVE: To turn off a circuit by blowing on it.

Build the circuit and turn it on; music plays. Since it is loud and annoying, try to shut it off by blowing into the microphone (X1). Blowing hard into the microphone stops the music, and then it starts again.

Project #177 Blow Off a Candle

OBJECTIVE: To turn off a circuit by blowing on it.

Replace the speaker (SP) with the 6V lamp (L2). Blowing hard into the microphone (X1) turns off the light briefly.

Project #178 Blow On a Doorbell

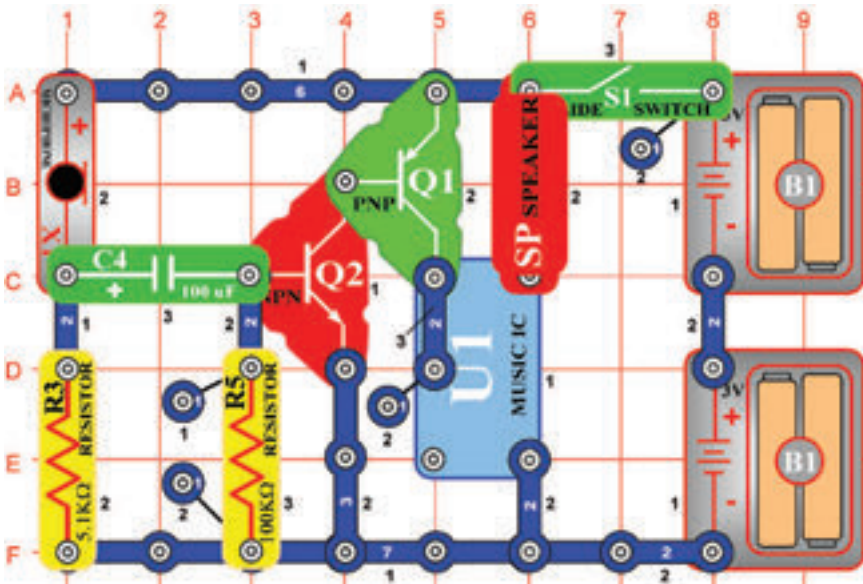

OBJECTIVE: To turn on a circuit by blowing on it.

Build the circuit and turn it on, music plays for a few moments and then stops. Blow into the microphone (X1) and it plays; it plays as long as you keep blowing.

Project #179 Blow On a Candle

OBJECTIVE: To turn on a circuit by blowing on it.

Replace the speaker (SP) with the 6V lamp (L2). Blowing into the microphone (X1) turns on the light, and then it goes off again.

Project #180 Screaming Fan

OBJECTIVE: To have an adjustable resistance control a fan and sounds.

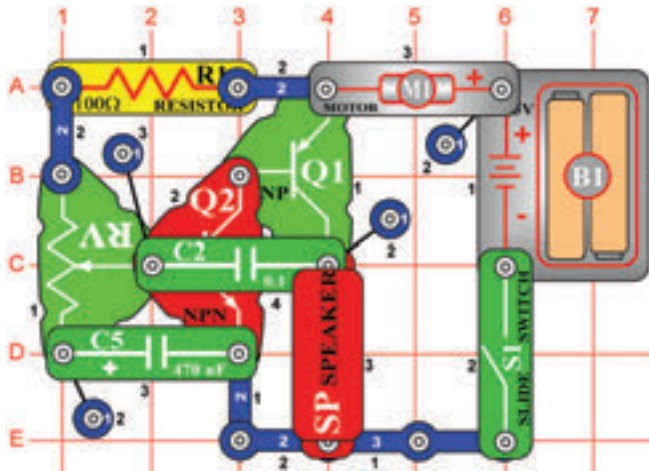

Build the circuit on the left and place the fan onto the motor (M1). Turn on the slide switch (S1) and move the setting on the adjustable resistor (RV) across its range. You hear screaming sounds and the fan spins.

WARNING: Moving parts. Do not touch the fan or motor during operation.

Project #181 Whining Fan

OBJECTIVE: To make different sounds.

Replace the 0.1μF capacitor (C2) with the 0.02μF capacitor (C1). The sounds are now a high-pitch whine and the motor (M1) starts a little sooner.

WARNING: Moving parts. Do not touch the fan or motor during operation.

Project #182 Light Whining

OBJECTIVE: To make different sounds.

Replace the 100Ω resistor (R1) at the upper-left of the circuit (points A1 & A3 on the base grid) with the photoresistor (RP), and wave your hand over it. The whining sound has changed a little and can now be controlled by light.

WARNING: Moving parts. Do not touch the fan or motor during operation.

Project #183 More Light Whining

OBJECTIVE: To make different sounds.

Replace the 0.02μF capacitor (C1) with the 0.1μF capacitor (C2). The sounds are lower in frequency and you can't make the fan spin now.

WARNING: Moving parts. Do not touch the fan or motor during operation.

Project #184 Motor That Won't Start

OBJECTIVE: To make different sounds.

Replace the 0.1μF capacitor (C2) with the 10μF capacitor (C3), put the positive (+) side towards the left). It now makes clicking sounds and the fan moves only in small bursts, like a motor that won't start.

WARNING: Moving parts. Do not touch the fan or motor during operation.

□ Project #185

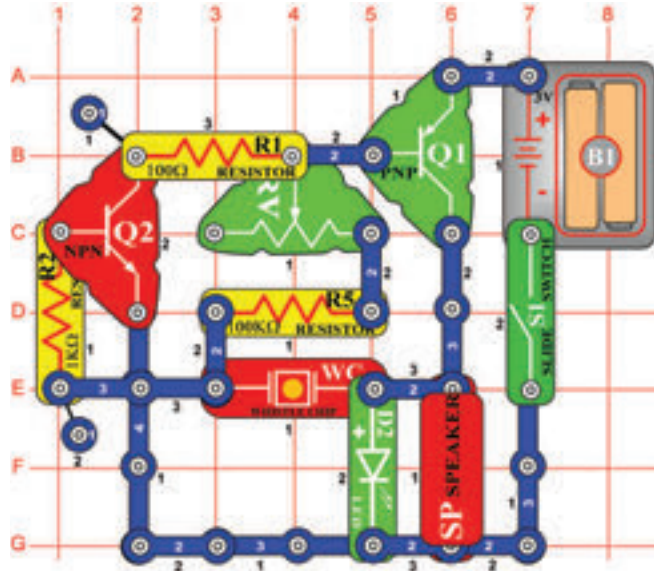

Whiner

OBJECTIVE: To build a circuit that makes a loud whine.

Build the circuit, turn it on, and move the setting on the adjustable resistor (RV). It makes a loud, annoying whine sound. The green LED (D2) appears to be on, but it is actually flashing at a very fast rate.

□ Project #186 Lower Pitch Whiner

OBJECTIVE: To show how adding capacitance reduces frequency.

Place the 0.02μF capacitor (C1) above the whistle chip (WC) and vary the adjustable resistor (RV) again. The frequency (or pitch) of the whine has been reduced by the added capacitance.

□ Project #187 Hummer

OBJECTIVE: To show how adding capacitance reduces frequency.

Now place the 0.1μF capacitor (C2) above the whistle chip (WC) and vary the adjustable resistor (RV) again. The frequency (or pitch) of the whine has been reduced by the greater added capacitance and it sounds more like a hum now.

□ Project #188 Adjustable Metronome

OBJECTIVE: To build an adjustable electronic metronome.

Now place the 10μF capacitor (C3, "+" side on right) above the whistle chip (WC) and vary the adjustable resistor (RV) again. There is no hum now but instead there is a click and a flash of light repeating about once a second, like the "beat" of a sound. It is like a metronome, which is used to keep time for the rhythm of a song.

□ Project #189 Quiet Flasher

OBJECTIVE: To make a blinking flashlight.

Leave the 10μF capacitor (C3) connected but replace the speaker (SP) with the 2.5V lamp (L1).



Project #190

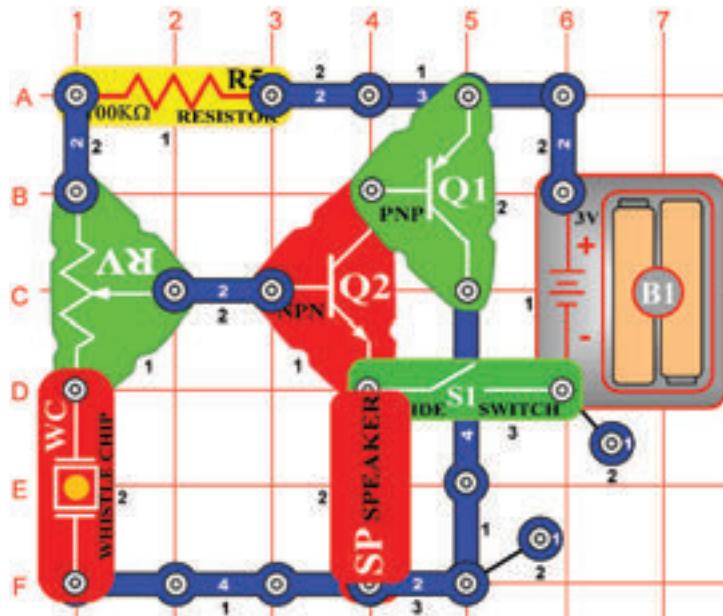

Hissing Foghorn

OBJECTIVE: *To build a transistor oscillator that can make a foghorn sound.*

Build the circuit on the left and move the adjustable resistor (RV) setting. Sometimes it will make a foghorn sound, sometimes it will make a hissing sound, and sometimes it will make no sound at all.



Project #191 Hissing & Clicking

OBJECTIVE: *To build an adjustable clicking oscillator.*

Modify the circuit in project #190 by replacing the 100kΩ resistor (R5) with the photoresistor (RP).
Move the adjustable resistor (RV) setting until you hear hissing sounds, and then shield the photoresistor while doing so and you hear clicking sounds.



Project #192 Video Game Engine Sound

OBJECTIVE: *To build a human oscillator.*

Remove the photoresistor (RP) from the circuit in project #191 and instead touch your fingers between the contacts at points A4 and B2 on the base grid while moving the adjustable resistor (RV). You hear a clicking that sounds like the engine sound in auto-racing video games.



Project #197

Water Alarm

OBJECTIVE: To sound an alarm when water is detected, tone will vary with salt content.

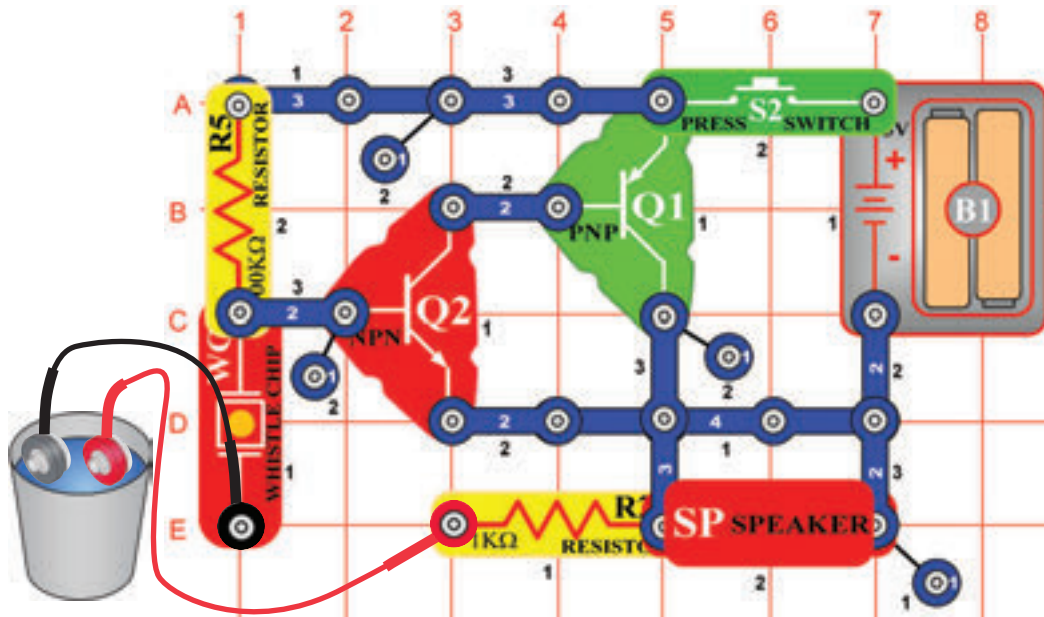

Build the circuit at left and connect the two (2) jumpers to it, place the loose ends of the jumpers into an empty cup (without them touching each other). Press the press switch (S2) - nothing happens. Add some water to the cup and an alarm will sound. Add salt to the water and the tone changes.

You can also test different liquids and see what tone they produce.



Project #198

Radio Announcer

OBJECTIVE: To hear your voice on the radio.

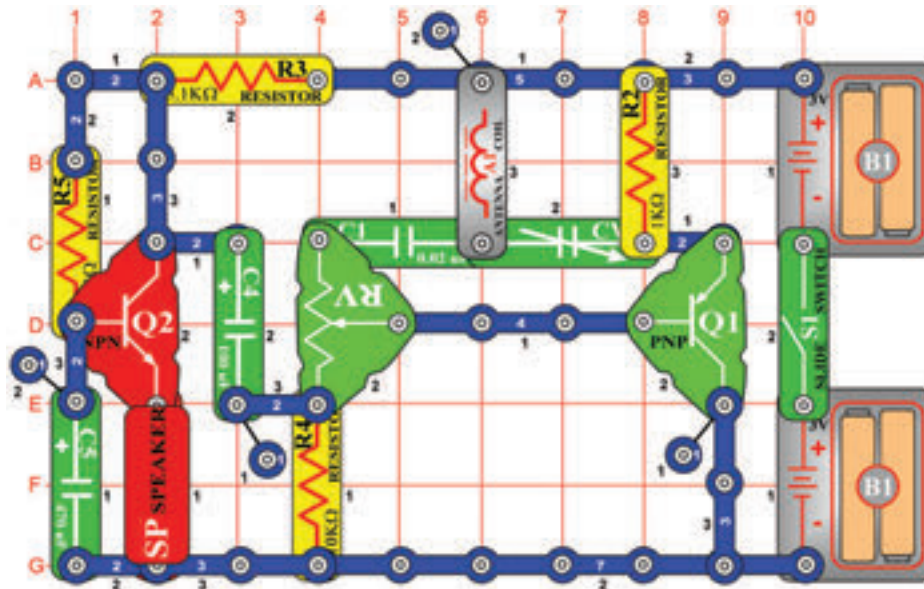

You need an AM radio for this project. Build the circuit shown but do not turn on the slide switch (S1). Place it within a foot of your AM radio and tune the radio frequency to the middle of the AM band (around 1000 kHz), where no other station is transmitting. Turn the volume up so you can hear the static. Set the adjustable resistor (RV) control to the middle setting. Turn on the slide switch and slowly tune the adjustable capacitor (CV) until the static on the radio becomes quiet. You may hear a whistle as you approach the proper tuning. In some cases you may also need to set the adjustable resistor slightly off-center.

When the radio static is gone, tap on the speaker (SP) with your finger and you should hear the sound of tapping on the radio. Now talk loudly into the speaker (used here as a microphone) and you will hear your voice on the radio. Set the adjustable resistor for best sound quality at the radio.

Project #199

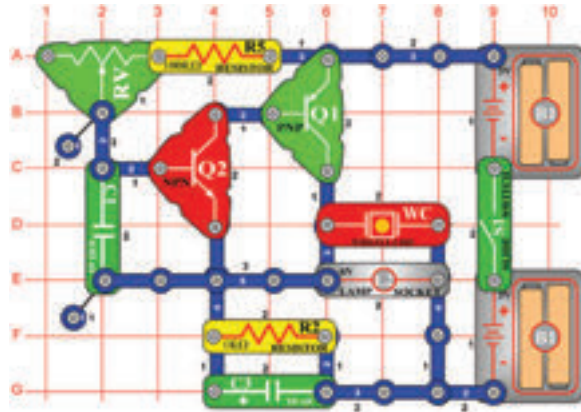

OBJECTIVE: To show how to change the pitch of a sound.

Build the circuit on the left, turn it on, and vary the adjustable resistor (RV). The *frequency* or *pitch* of the sound is changed. Pitch is the musical profession's word for frequency. If you've had music lessons, you may remember the music scale using chords such as A3, F5, and D2 to express the *pitch* of a sound. Electronics prefers the term *frequency*, as in when you adjust the frequency on your radio.

Pitch

Project 200 Pitch (II)

OBJECTIVE:
See project #199.

Since we've seen we can adjust the frequency by varying the resistance in the adjustable resistor, are there other ways to change frequency? You can also change frequency by changing the capacitance of the circuit. Place the 0.1μF capacitor (C2) on top of the 0.02μF capacitor (C1); notice how the sound has changed.

Project 201 Pitch (III)

OBJECTIVE:
See project #199.

Remove the 0.1μF (C2) capacitor and replace the 100kΩ resistor (R5) with the photoresistor (RP). Wave your hand up and down over the photoresistor to change the sound. Changing the light on the photoresistor changes the circuit resistance just like varying the adjustable resistance does.
Note: If you have the adjustable resistor (RV) set to the right and light shining on the photoresistor, then you may not get any sound because the total resistance is too low for the circuit to operate.

Project #202

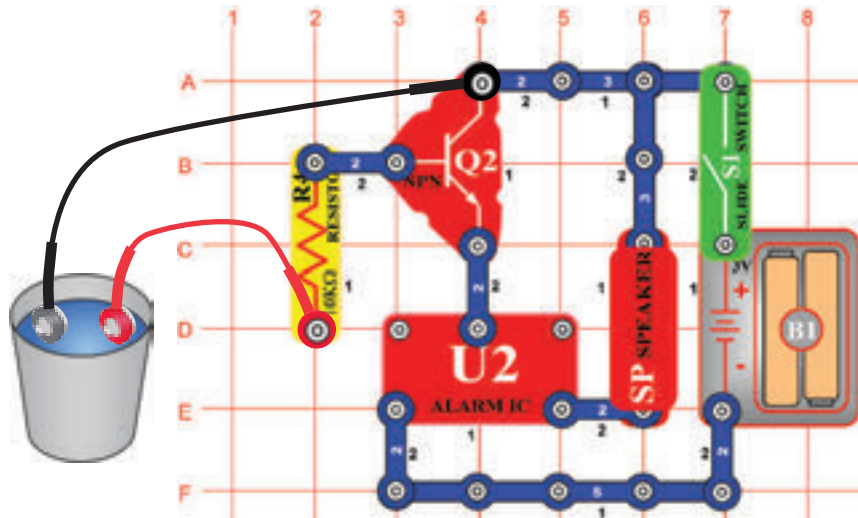

Flooding Alarm

OBJECTIVE: To sound an alarm when water is detected.

Build the circuit on the left and connect the two (2) jumpers to it, place the loose ends of the jumpers into an empty cup (without them touching each other). Turn on the slide switch (S1) - nothing happens. This circuit is designed to detect water and there is none in the cup. Add some water to the cup - an alarm sounds!

You can use longer jumper wires and hang them near your basement floor or next to your sump pump to give a warning if your basement is being flooded. Note that if the loose jumper ends accidentally touch then you will have a false alarm.



Project #203

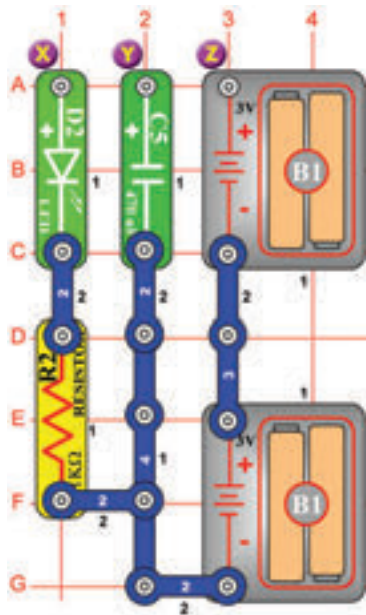

Make Your Own Battery

OBJECTIVE: To demonstrate how batteries can store electricity.

Build the circuit, then connect points Y & Z (use a 2-snap wire) for a moment. Nothing appears to happen, but you just filled up the 470µF capacitor (C5) with electricity. Now disconnect Y & Z and instead touch a connection between X & Y. The green LED (D2) will be lit and then go out after a few seconds as the electricity you stored in it is discharged through the LED and resistor (R2).

Notice that a capacitor is not very efficient at storing electricity - compare how long the 470µF kept the LED lit for with how your batteries run all of your projects! That is because a capacitor stores electrical energy while a battery stores chemical energy.



Project #204 Make Your Own Battery (II)

OBJECTIVE: To demonstrate how batteries can store electricity.

In the preceding circuit, replace the 470µF capacitor (C5) with the 100µF capacitor (C3) and repeat the test. You see that the LED (D2) goes out faster, because the 100µF capacitor does not store as much electricity as the 470µF.



Project #205 Make Your Own Battery (III)

OBJECTIVE: To demonstrate how batteries can store electricity.

Now replace the 1kΩ resistor (R2) with the 100Ω resistor (R1) and try it. The LED (D2) gets brighter but goes out faster because less resistance allows the stored electricity to dissipate faster.



Project #206

Tone Generator

OBJECTIVE: To build a high-frequency oscillator.

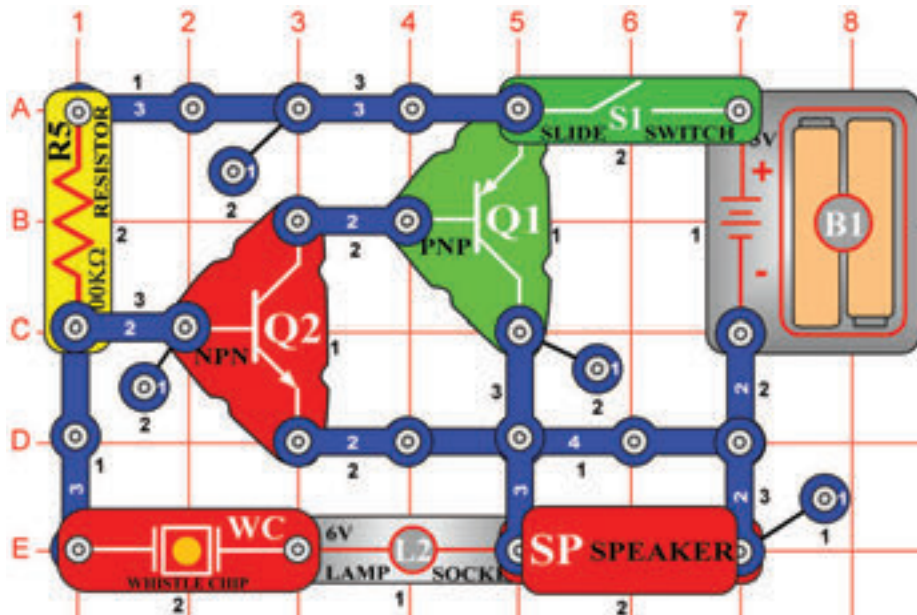

Build the circuit and turn it on, you hear a high-frequency sound.



Project #207 Tone Generator (II)

OBJECTIVE: To lower the frequency of a tone by increasing circuit capacitance.

Place the 0.02 μ F capacitor (C1) on top of the whistle chip (WC) in the preceding circuit, you hear a middle-frequency sound. Why? The whistle chip is used here as a capacitor and by placing the 0.02 μ F on top (in parallel) we have increased the capacitance, and doing so lowers the frequency.



Project #208 Tone Generator (III)

OBJECTIVE: To lower the frequency of a tone by increasing circuit capacitance.

Next, replace the 0.02 μ F capacitor (C1) and the whistle chip (WC) with the larger 0.1 μ F capacitor (C2). You now hear a low frequency sound, due to yet more capacitance.



Project #209 Tone Generator (IV)

OBJECTIVE: To lower the frequency of a tone by increasing circuit capacitance.

Now replace the 0.1 μ F (C2) with the much larger 10 μ F capacitor (C3), (orient with the positive (+) side towards the left); the circuit just clicks about once a second. There isn't a constant tone anymore due to other transistor properties. You need a different type of circuit to create very low frequency tones.



Project #210

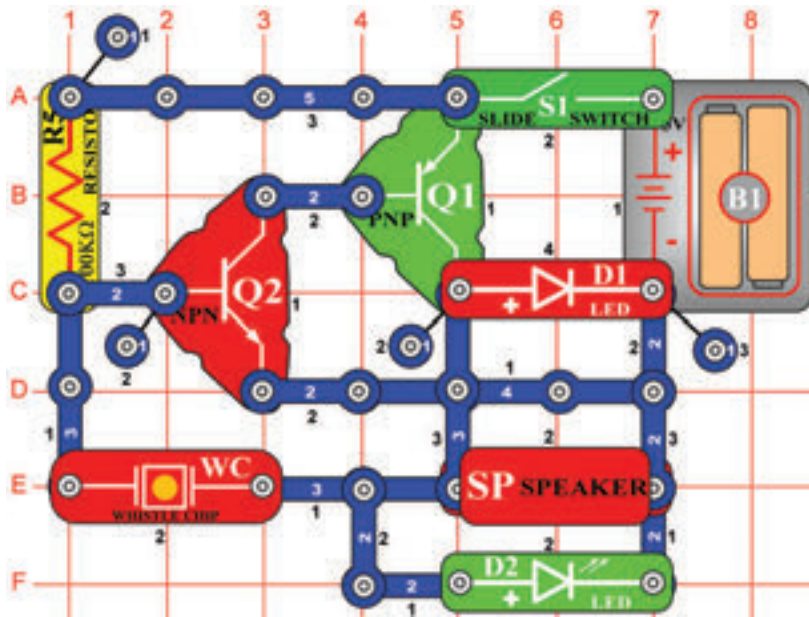

More Tone Generator

OBJECTIVE: To build a middle-frequency oscillator.

Build the circuit, as the name suggests this circuit is similar to that in project #206. Turn it on, you hear a middle-frequency sound.



Project #211 More Tone Generator (II)

OBJECTIVE: To lower the frequency of a tone by increasing circuit capacitance.

Place the $0.02\mu\text{F}$ capacitor (C1) or the $0.1\mu\text{F}$ capacitor (C2) on top of the whistle chip (WC). The sound is different now because the added capacitance has lowered the frequency. The LED's appear to be on, but are actually blinking at a very fast rate.



Project #212 More Tone Generator (III)

OBJECTIVE: To lower the frequency of a tone by increasing circuit capacitance.

Now place the $10\mu\text{F}$ capacitor (C3) on top of the whistle chip (WC). You hear a clicking sound as the LED's blink about once a second.

Project #213 Music Radio Station

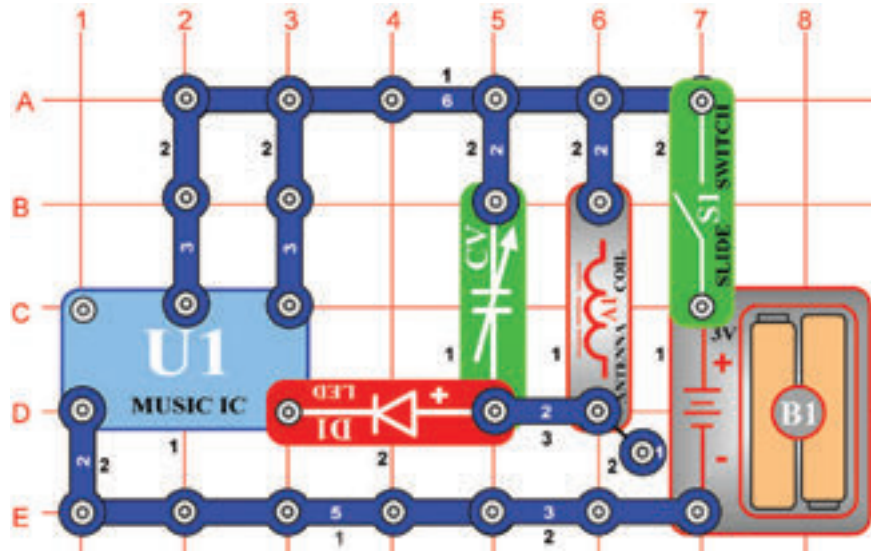

OBJECTIVE: To create music and transmit it to a radio.

You need an AM radio for this project. Build the circuit shown on the left and turn on the slide switch (S1). Place it next to your AM radio and tune the radio frequency to where no other station is transmitting.

Then, tune the variable capacitor (CV) until your music sounds best on the radio.

Project #214 Alarm Radio Station

OBJECTIVE: To create music and transmit it to a radio.

Replace the music IC (U1) with the alarm IC (U2), and then you will hear a machine gun sound on the radio. You may need to re-tune the variable capacitor (CV).

Project #215

Standard Transistor Circuit

OBJECTIVE: To save some electricity for later use.

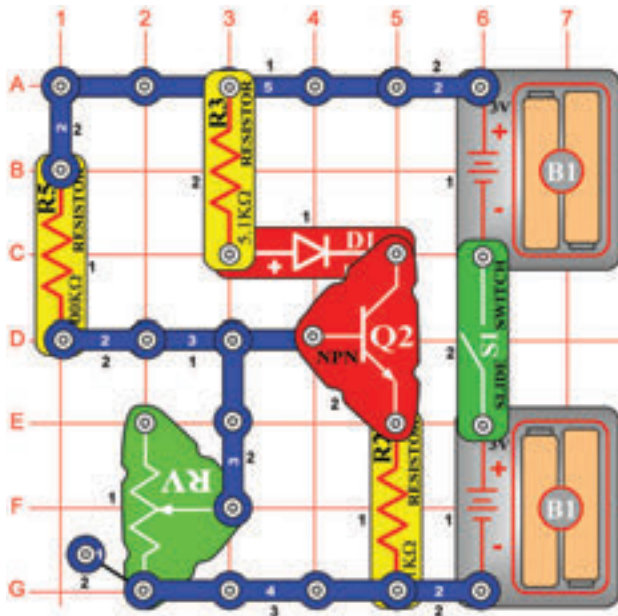

Turn on the slide switch (S1) and move the adjustable resistor (RV) control lever across its range. When the lever is all the way down the LED (D1) will be off, as you move the lever up it will come on and reach full brightness.

This circuit is considered the standard transistor configuration for amplifiers. The adjustable resistor control will normally be set so that the LED is at half brightness, since this minimizes distortion of the signal being amplified.



Project #216

Motor & Lamp by Sound

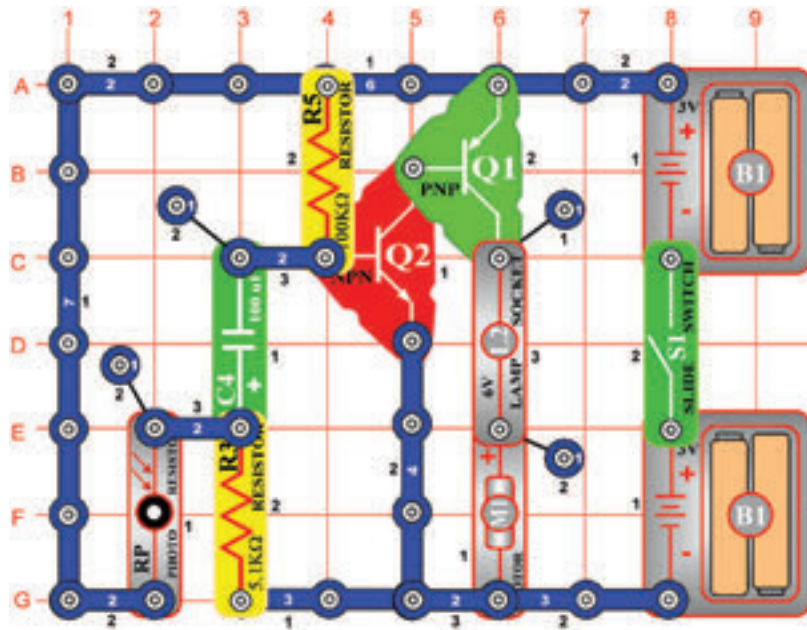

OBJECTIVE: To control a motor using light.

Turn the slide switch (S1) on, the motor (M1) spins and the lamp (L2) lights. As you move your hand over the photoresistor (RP), the motor slows. Now place finger onto the photoresistor to block the light. The motor slows down. In a few seconds, the motor speeds up again.

WARNING: Moving parts. Do not touch the fan or motor during operation.



Project #217

Fading Siren

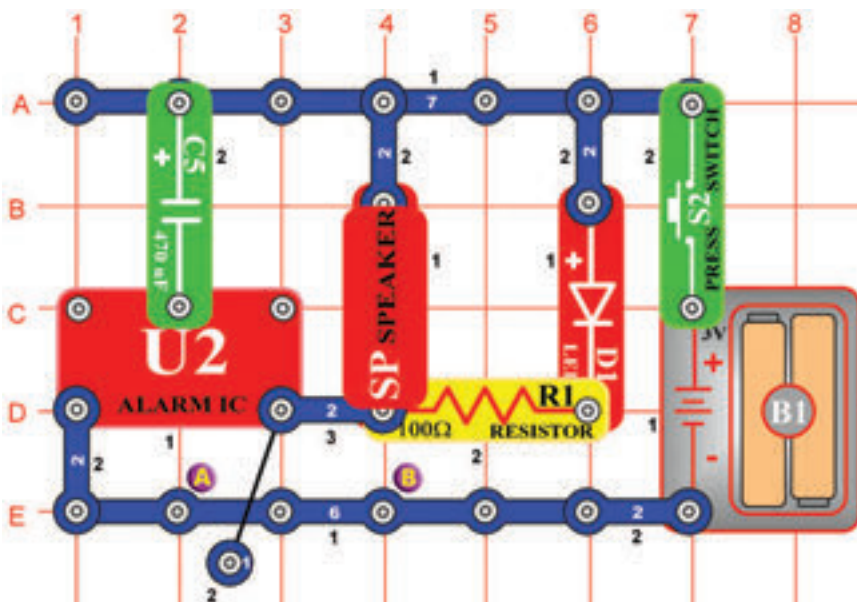

OBJECTIVE: To produce sound of a siren driving away into the distance.

Press the press switch (S2), the alarm IC (U2) should make the sound of an up-down siren that gets weaker with time. The fading is produced by the charging of the 470µF capacitor (C5). After it is charged the current stops and the sound is very weak. To repeat this effect you must release the press switch, remove the capacitor, and discharge it by placing it across the snaps on the bottom bar marked A & B. Then, replace the capacitor and press the switch again.



Project #218 Fast Fade Siren

OBJECTIVE: To produce sound of a siren driving away into the distance.

Replace the 470µF capacitor (C5) with the 100µF capacitor (C4), the siren fades faster.



Project #219

Laser Gun with Limited Shots

OBJECTIVE: To build a circuit with laser gun sounds and a limited amount of shots.

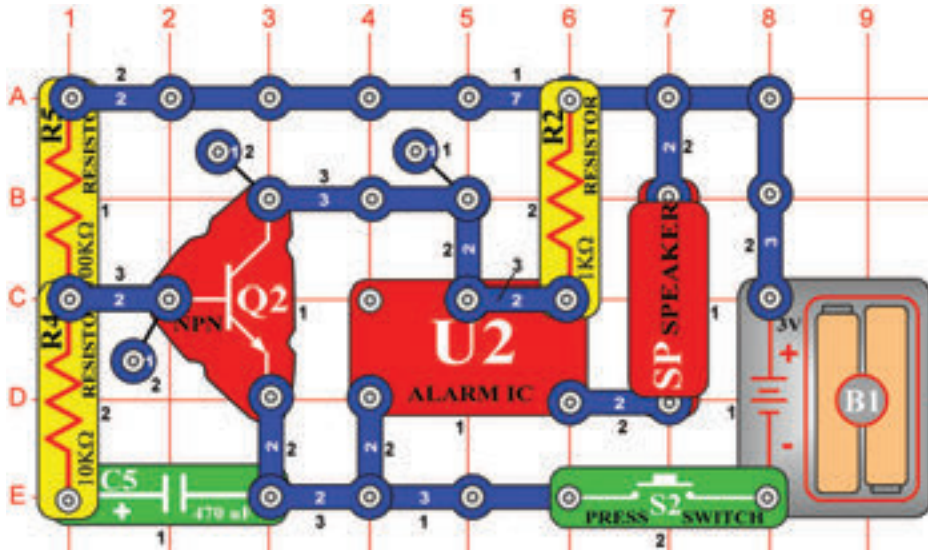

When you press the press switch (S2), the alarm IC (U2) should start sounding a very loud laser gun sound. The speaker (SP) will sound, simulating a burst of laser energy. You can shoot long repeating laser burst, or short zaps by tapping the trigger switch. But be careful, this gun will run out of energy and you will have to wait for the energy pack (C5) to recharge. This type of gun is more like a real life laser gun because power would run out after a few shots due to energy drain. In a real laser, the energy pack would have to be replaced. Here you only have to wait a few seconds for recharge.



Project #220 Symphony of Sounds

OBJECTIVE: To combine sounds from the music, alarm, and space war integrated circuits.

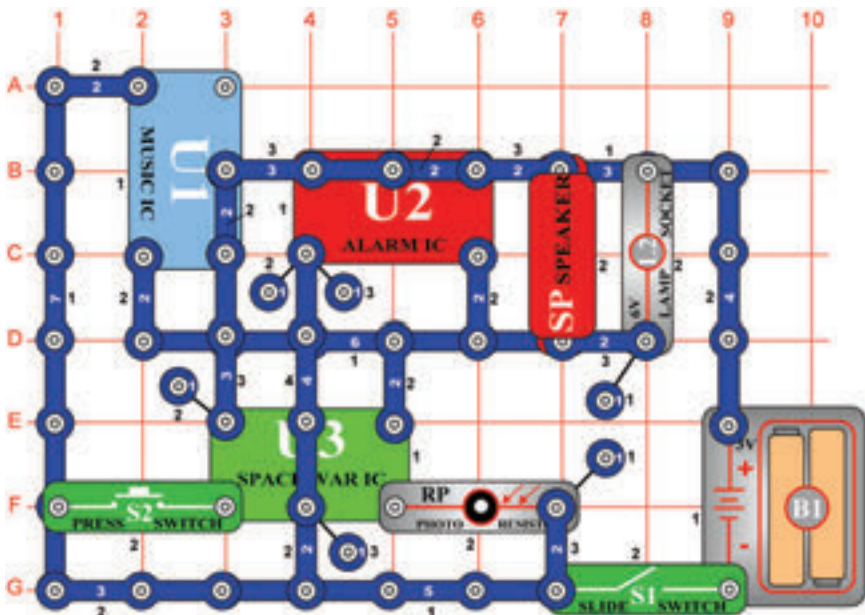

Build the circuit shown. Turn it on and press the press switch (S2) several times and wave your hand over the photoresistor (RP) to hear the full symphony of sounds that this circuit can create. Have fun!



Project #221 Symphony of Sounds (II)

OBJECTIVE: See project #220.

The preceding circuit may be too loud, so replace the speaker (SP) with the whistle chip (WC). Can you guess why the jumper is used in this circuit? It is being used as just a 3-snap wire because without it you don't have enough parts to build this complex circuit.

Project #222

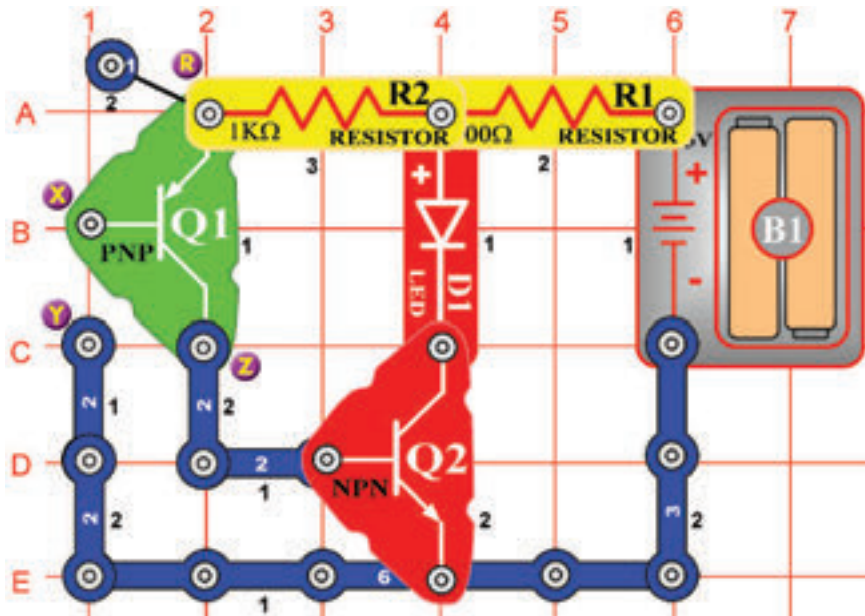

Transistor Amplifiers

OBJECTIVE: To learn about the most important component in electronics.

When you place one or more fingers across the two snaps marked X & Y you will notice the LED (D1) turns on. The two transistors are being used to amplify the very tiny current going through your body to turn on the LED. Transistors are actually electrical current amplifiers. The PNP transistor (Q1) has the arrow pointing into the transistor body. The NPN transistor (Q2) has the arrow pointing out of the transistor body. The PNP amplifies the current from your fingers first, then the NPN amplifies it more to turn on the LED.

Project #223 Pressure Meter

OBJECTIVE: To show how electronic amplifiers can detect skin pressure on two contacts.

Use the circuit from project #222 shown above.

When you placed your fingers across the two snaps marked X & Y you noticed the LED (D1) came on in project #222. Repeat this process, but this time press very lightly on the two snaps marked X & Y. Notice how the brightness of the LED is dependent on the amount of pressure you use. Pressing hard makes the LED bright while pressing very gently makes it dim or even flash. This is due to what technicians call "contact resistance". Even switches made to turn your lights on and off have some resistance in them. When large currents flow, this resistance will drop the voltage and produce the undesirable side effect of heat.

Project #224 Resistance Meter

OBJECTIVE: To show how electronic amplifiers can detect different values of resistance.

Use the circuit from project #222 shown above

When you placed your fingers across the two snaps marked X & Y you noticed the LED (D1) came on in project #222. In this project, you will place different resistors across R & Z and see how bright the LED glows. Do not snap them in; just press them up against the snaps labeled R & Z in the diagram above.

First, place the 100kΩ resistor (R5) across the R & Z snaps and note the brightness of the LED. Next, press the 5.1kΩ resistor (R3) across R & Z. Notice how the LED gets brighter when the resistance is less. This is because the NPN amplifier (Q2) gets more current at its input when the resistance is lower. The PNP amplifier (Q1) is not used in this test.



Project #225

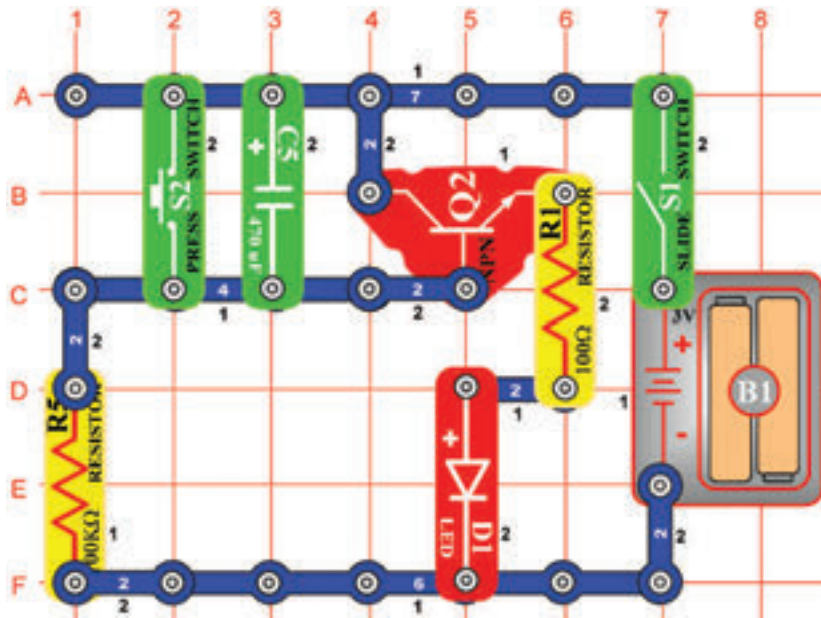

Auto-Off Night-Light

OBJECTIVE: To learn about one device that is used to delay actions in electronics.

When you turn on the slide switch (S1) the first time the LED (D1) will come on and very slowly get dimmer and dimmer. If you turn the slide switch (S1) off and back on after the light goes out it will NOT come on again. The 470µF capacitor (C5) has charged up and the NPN transistor amplifier (Q2) can get no current at its input to turn it on.

This circuit would make a good night-light. It would allow you to get into bed, and then it would go out. No further current is taken from the battery so it will not drain the batteries (B1) even if left on all night.



Project #226 Discharging Caps

OBJECTIVE: To show how capacitor delays can be repeated by discharging the capacitor.

Use the circuit from project #225 shown above.

When you first turned on the slide switch (S1) in project #225, the LED (D1) came on and very slowly got dimmer and dimmer. When you turned the slide switch (S1) off and back on after the light went out, it did NOT come on again. The 470µF capacitor (C5) was charged and everything stopped. This time turn the slide switch off. Then press the press switch (S2) for a moment to discharge the 470µF capacitor. Now when you turn the slide switch back on the delay repeats. Shorting a capacitor with a low resistance will allow the charges on the capacitor to leave through the resistance. In this case, the low resistance was the press switch.



Project #227 Changing Delay Time

OBJECTIVE: To show how the size of the capacitor effects the delay time.

Use the circuit from project #225 shown above.

Change the 470µF capacitor (C5) to the 100µF capacitor (C4). Make sure the capacitor (C4) is fully discharged by pressing the press switch (S2) before closing the on-off slide switch (S1). When slide switch is turned on, notice how much quicker the LED (D1) goes out. Since 100µF is approximately 5 times smaller than 470µF, the LED will go out 5 times faster. The bigger the capacitor the longer the delay.

In electronics, capacitors are used in every piece of equipment to delay signal or tune circuits to a desired frequency.



Project #228

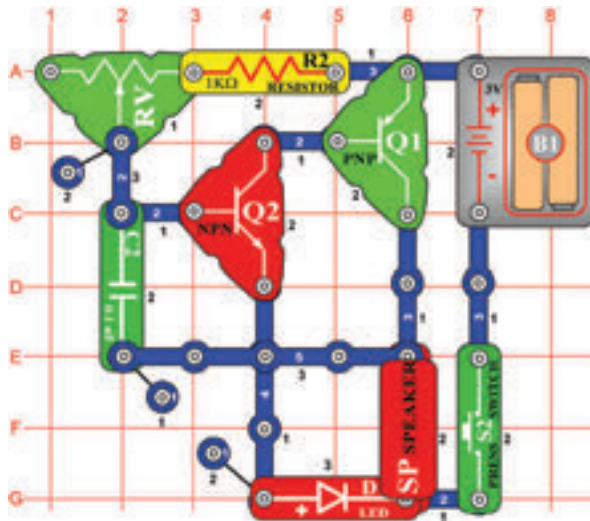

Morse Code Generator

OBJECTIVE: To make a Morse code generator and learn to generate code.

When you press down on the press switch (S2) you will here a tone. By pressing and releasing the press switch you can generate long and short tones called Morse code. For International code, a short tone is represented by a “+”, and a long tone by a “-”. See the chart below for letter or number followed by code.

A+-	G---+	M--	S+++	Y-+---	5+++++
B-+++	H++++	N-+	T-	Z--++	6-++++
C-+-+	I++	O---	U+-	1+-----	7-++++
D-++	J+---	P+---	V+++-	2+-----	8-++++
E+	K-+-	Q--+-	W+---	3++++-	9-++++
F+-+	L-++	R+-	X-+-	4++++-	0-----



Project #229 LED Code Teacher

OBJECTIVE: A method of learning the Morse code without all the noise.

Use the circuit from project #228 shown above. Replace the speaker with a 100Ω resistor (R1) so you can practice generating the Morse code without the loud speaker. Have someone transmit code and watch the LED. Tell them the letter or number after each is generated. When you have learned code, replace the speaker.



Project #230 Ghost Shriek Machine

OBJECTIVE: To make a ghost like special effect from the Morse code generator.

Use the circuit from project #228 shown above, but change the 1kΩ resistor (R2) to a 10kΩ resistor (R4), and .1μF capacitor (C2) to the variable capacitor (CV). While holding the press switch (S2) down adjust both the adjustable resistor (RV) and the variable capacitor for a ghost like sound. At certain settings, sound may stop or get very faint.



Project #231 LED & Speaker

OBJECTIVE: To improve Morse code skills and visual recognition.

Use the circuit from project #228 shown above. Try and find a person that already knows the Morse code to send you a message with both sound and LED flashing. Try in a dark room first so LED (D1) is easier to see. Morse code is still used by many amateur radio operators to send messages around the world.



Project #232 Dog Whistle

OBJECTIVE: To make an oscillator that only a dog can hear.

Use the circuit from project #228 shown above, but change the 1kΩ resistor (R2) to the 100Ω resistor (R1). While holding down the press switch (S2), move the slider on the adjustable resistor (RV) around. When the slider is near the 100Ω resistor you won't hear any sound, but the circuit is still working. This oscillator circuit is making sound waves at a frequency too high for your ears to hear. But your dog may hear it, because dogs can hear higher frequencies than people can.

Project #233

Mind Reading Game

OBJECTIVE: To make an electronic game of mind reading.

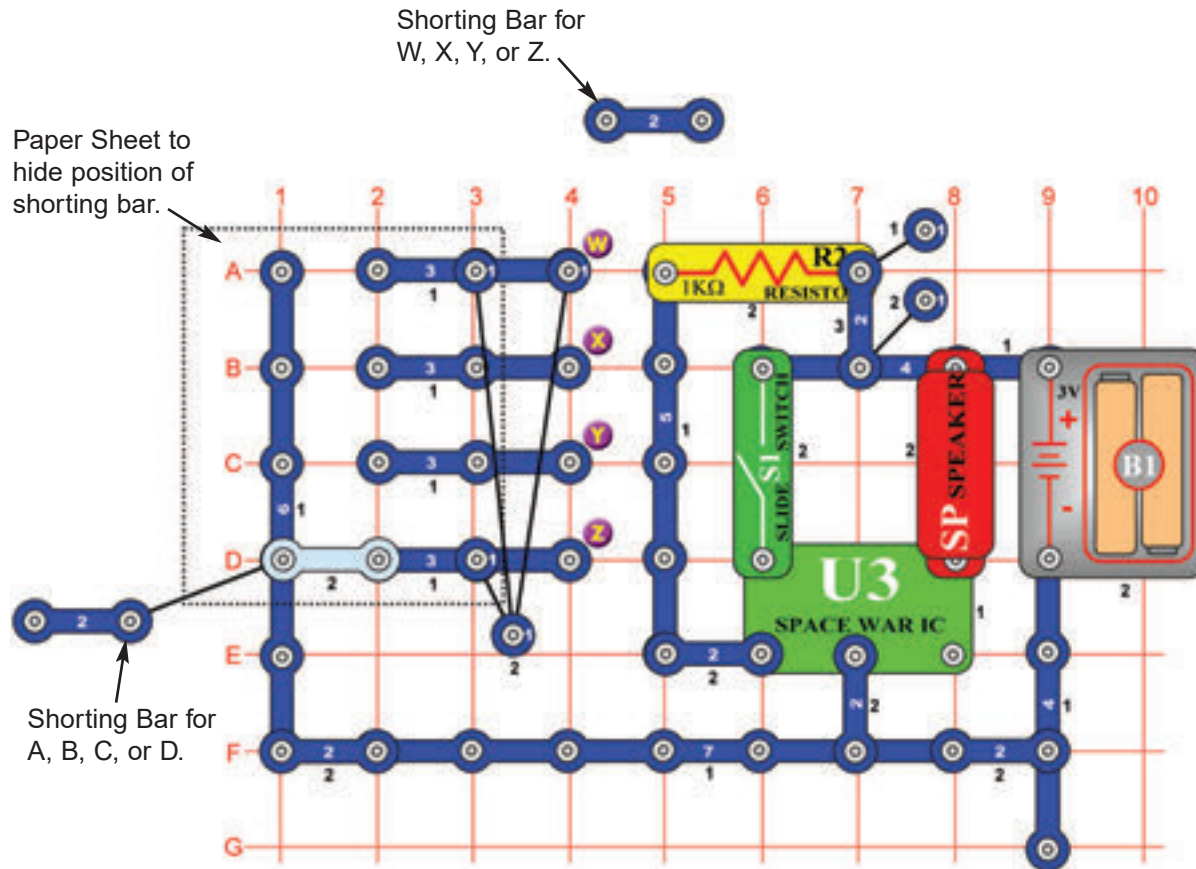

Build the circuit shown on the left. It uses two (2) 2-snap wires as shorting bars.

Setup: Player 1 sets up by placing one shorting bar under the paper on row A, B, C, or D. Player 2 must **NOT** know where the shorting bar is located under the paper.

The object is for Player 2 to guess the location by placing his shorting bar at positions W, X, Y, or Z. In the drawing on the left, Player 1 set up at position "D". If Player 2 places his shorting bar across "Z" on the first try, then he guessed correctly and marks a 1 on the score card sheet under that round number. If it takes three tries, then he gets a three.

Player 2 then sets the A, B, C, D side and Player 1 tries his luck. Each player records his score for each round. When all 18 rounds have been played, the player with the lowest score wins. Additional players can play. Use the score card below to determine the winner.

Round #	1	2	3	4	5	6	7	8	9	10	11	12	13	14	15	16	17	18	Total
Player 1	_____	_____	_____	_____	_____	_____	_____	_____	_____	_____	_____	_____	_____	_____	_____	_____	_____	_____	_____
Player 2	_____	_____	_____	_____	_____	_____	_____	_____	_____	_____	_____	_____	_____	_____	_____	_____	_____	_____	_____
Player 3	_____	_____	_____	_____	_____	_____	_____	_____	_____	_____	_____	_____	_____	_____	_____	_____	_____	_____	_____
Player 4	_____	_____	_____	_____	_____	_____	_____	_____	_____	_____	_____	_____	_____	_____	_____	_____	_____	_____	_____



Project #234

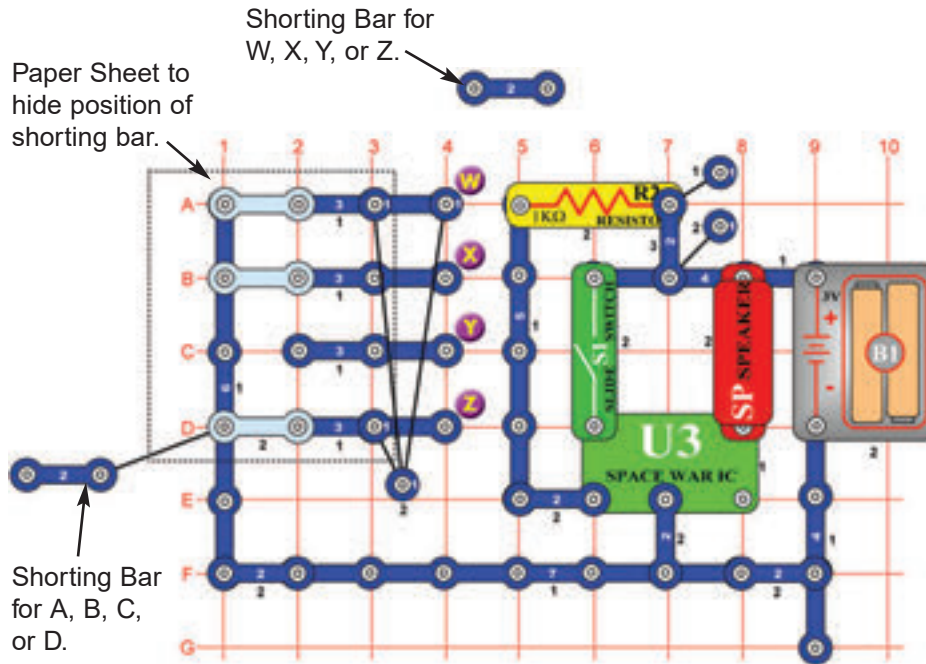

Enhanced Quiet Zone Game

OBJECTIVE: Make and play the electronic game of “Quiet Zone”.

Use the circuit from project #233, but place three (3) 2-snap wires (“shorting bars”) under paper as shown on left.

Setup: Player 1 sets the “Quiet Zone” by placing three (3) shorting bars under the paper on row A, B, C, or D, leaving only one open. Player 2 must **NOT** know where the shorting bars are located under the paper.

Both Player 1 and Player 2 are given 10 points. The object is for Player 2 to guess the location of the “Quiet Zone” by placing his shorting bar at positions W, X, Y, or Z. In the drawing on the left Player 1 set up the “Quiet Zone” at position “C”. If Player 2 places his shorting bar across “Z” on the first try, the sounds played mean he has not found the “Quiet Zone” and he loses 1 point. He has 3 tries to find the zone on each turn. Each time sounds are made he loses a point.

Player 2 then sets the A, B, C, D side and Player 1 starts searching. Play continues until one player is at zero points and makes sound during that players turn.



Project #235

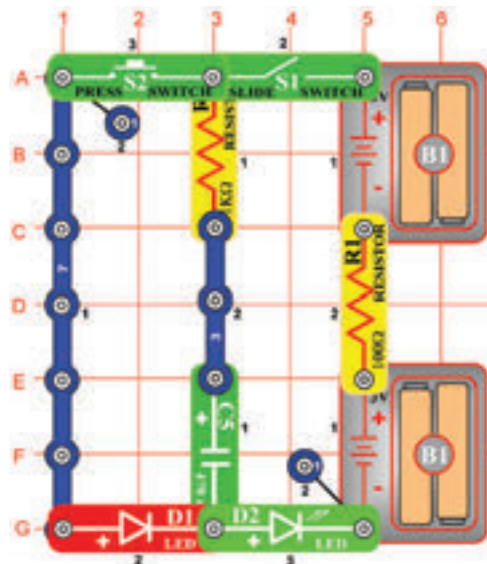

Capacitor Charge & Discharge

OBJECTIVE: To show how capacitors store and release electrical charge.

Turn on the slide switch (S1) for a few seconds, then turn it off. The green LED (D2) is initially bright but goes dim as the batteries (B1) charge up the 470µF capacitor (C5). The capacitor is storing electrical charge.

Now press the press switch (S2) for a few seconds. The red LED (D1) is initially bright but goes dim as the capacitor discharges itself through it.

The capacitor value (470µF) sets how much charge can be stored in it, and the resistor value (1kΩ) sets how quickly that charge can be stored or released.



Project #236

Sound Wave Magic

OBJECTIVE: To show how sound waves travel on a paper surface.

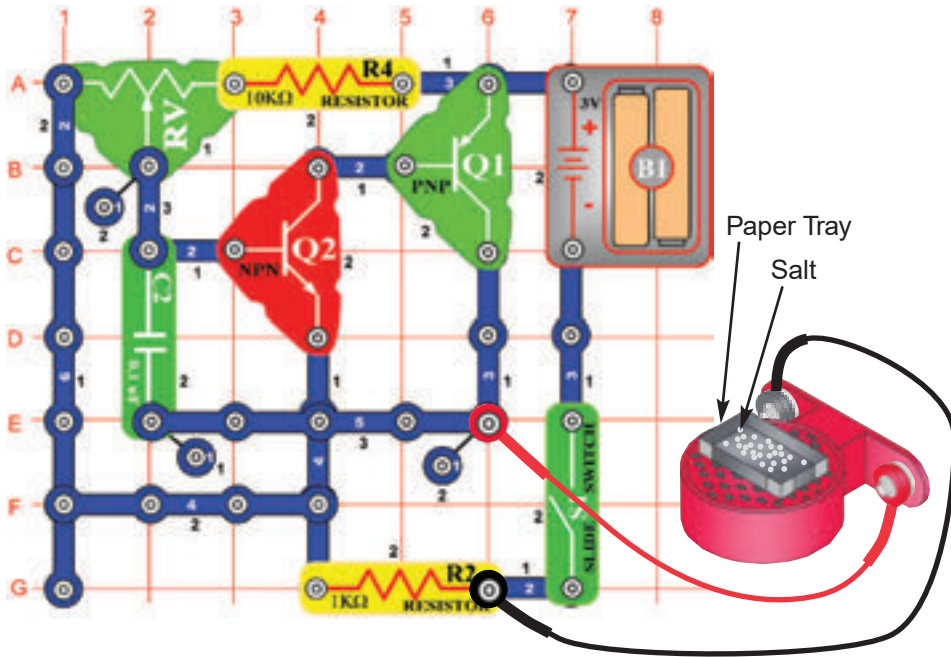

Build the circuit shown on the left and connect the speaker (SP) using the two (2) jumper wires. Then, lay the speaker on a flat hard surface.

Setup: Use some paper and scissors to cut out a rectangular pattern. Use the one shown below as a guide. Use colored paper if available. Fold at the points shown. Scotch tape the corners so the tray has no cracks at the corners. Place the tray over the speaker and sprinkle a small amount of white table salt in the tray. There should be enough salt to cover the bottom with a little space between each salt grain.

Sound Magic: Turn on the circuit by turning on the slide switch (S1). Adjust the adjustable resistor (RV) for different pitches and watch the salt particles. Particles that bounce high are directly over the vibrating paper and ones that do not move are in the nodes where the paper is not vibrating. Eventually, all the salt will move to the areas that have no vibration, and stay there. Change the position of the tray and the material used to create different patterns due to the sound. Try sugar and coffee creamer, for example, to see if they move differently due to the sound waves.

Sample Cut-out Pattern

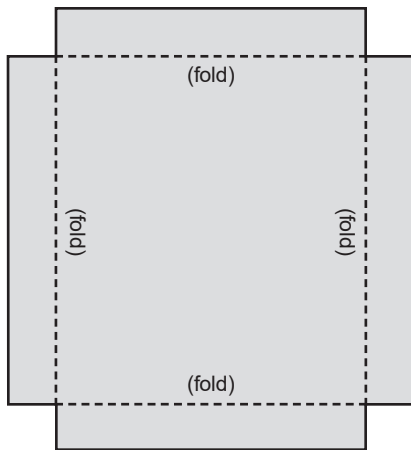

Project #237

Space War Amplifier

OBJECTIVE: To amplify sounds from the space war integrated circuit.

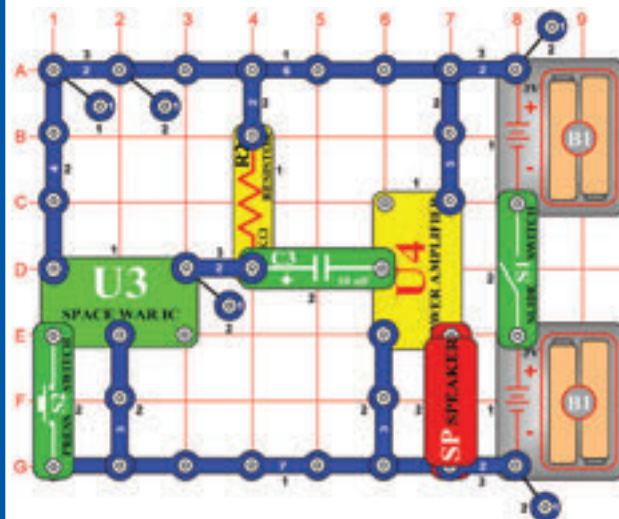

Build the circuit, turn on the slide switch (S1), and press the press switch (S2) several times. You will hear loud space war sounds, since the sound from the space war IC (U3) is amplified by the power amplifier IC (U4). Nearly all toys that make sound use a power amplifier of some sort.



Project #238

Trombone

OBJECTIVE: To build an electronic trombone that changes pitch of note with slider bar.

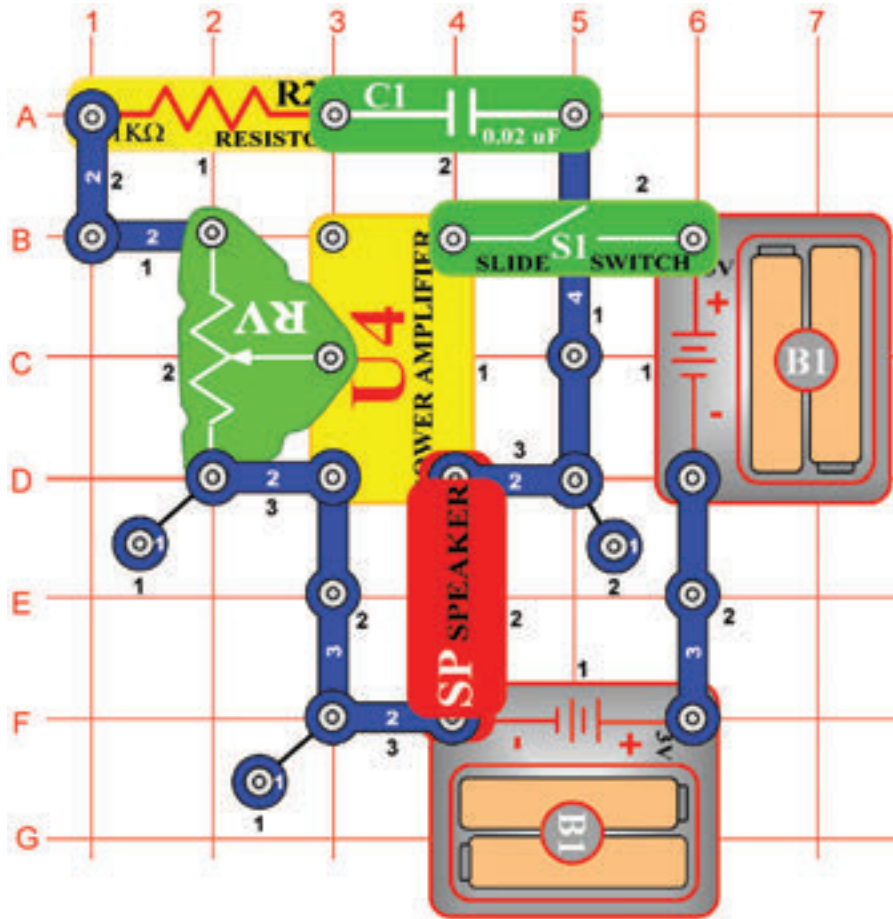

When you turn on the slide switch (S1) the trombone should start playing. To change the pitch of the note, simply slide the adjustable resistor (RV) control back and forth. By turning the slide switch on and off and moving the slider, you will be able to play a song much like a trombone player makes music. The switch represents air going through the trombone, and the adjustable resistor control is the same as a trombone slider bar. The circuit may be silent at some positions of the resistor control.



Project #239

Race Car Engine

OBJECTIVE: To show how changing frequency changes the sound to a different special effect.

Use the circuit from project #238 shown on the left, but change the 0.02 μF capacitor (C1) to a 10 μF capacitor (C3). Make sure the positive (+) mark on the capacitor is **NOT** on the resistor (R2) side when you snap it in.

When the slide switch (S1) is turned on, you should hear a very low frequency oscillation. By sliding the adjustable resistor (RV) control up and down, you should be able to make the sound of a race car engine as it's motor speeds up and slows down.

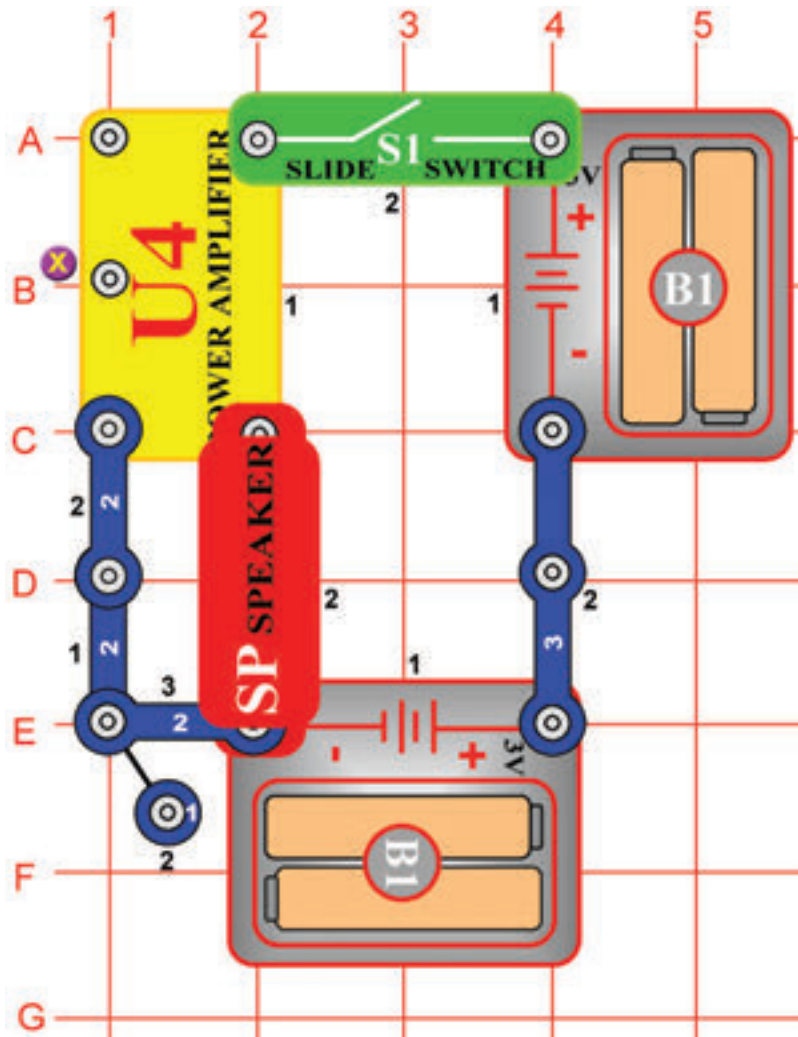

Project #240 Power Amplifier

OBJECTIVE: To check stability of power amplifier with open input.

When you turn on the slide switch (S1), the power amplifier IC (U4) should not oscillate. You should be able to touch point X with your finger and hear static. If you do not hear anything, listen closely and wet your finger that touches point X. High frequency clicks or static should be coming from speaker (SP) indicating that the amplifier is powered on and ready to amplify signals.

The power amplifier may oscillate on its own. Do not worry, this is normal with high gain high-powered amplifiers.



Project #241 Feedback Kazoo

OBJECTIVE: To show how electronic feedback can be used to make a musical instrument.

Use the circuit from project #240 shown on the left.

When you place one finger on point X and a finger from your other hand on the speaker (SP) snap that is not connected to the battery (B1), what happens? If the amplifier starts to oscillate it is due to the fact that you just provided a feedback path to make the amplifier into an oscillator. You may even be able to change the pitch of the oscillation by pressing harder on the snaps.

This is the principle used to make an electronic kazoo. If you practice and learn the amount of pressure required to make each note, you may even be able to play a few songs.



Project #242

AM Radio

OBJECTIVE: To make a complete working AM radio.

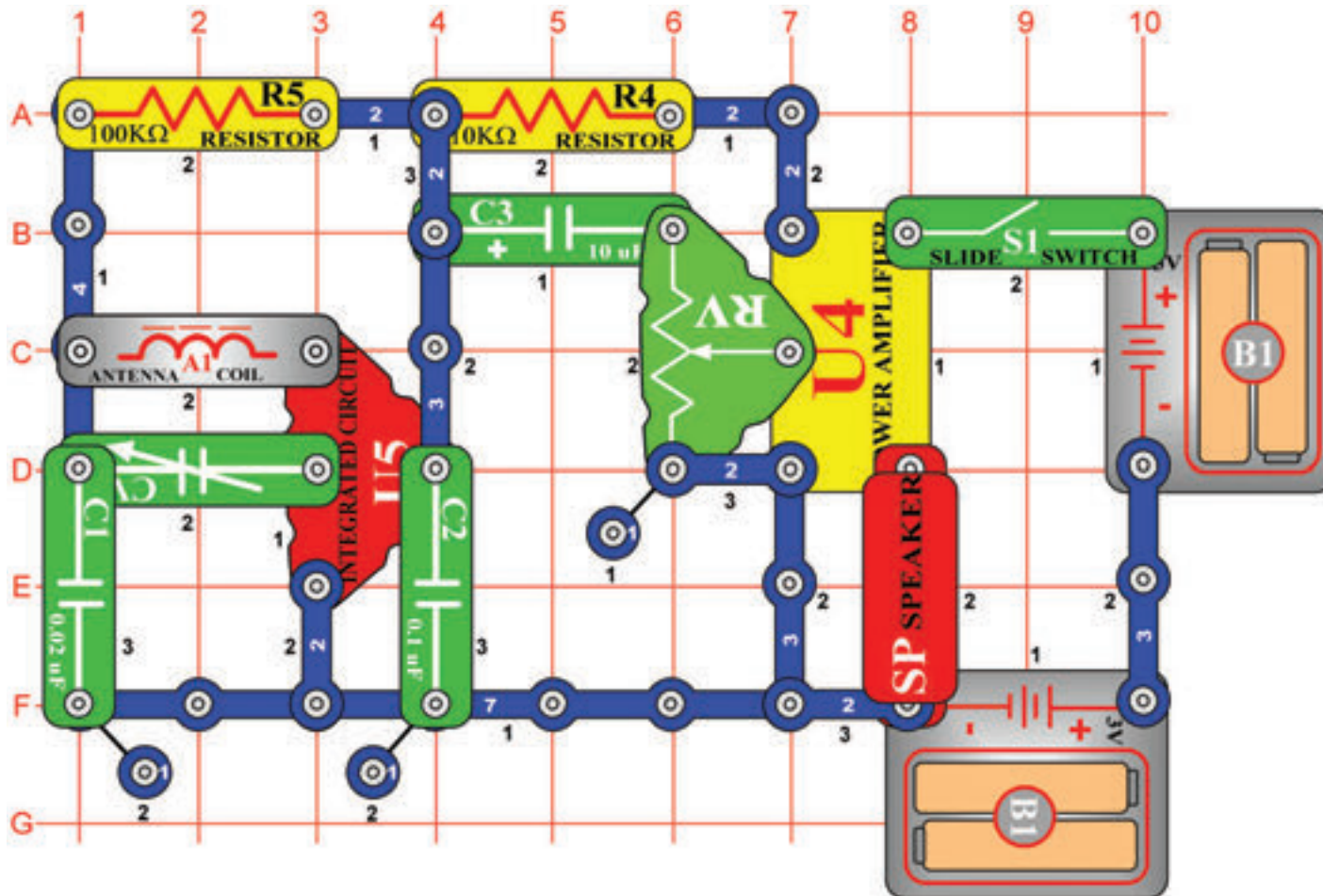

When you turn on the slide switch (S1), the integrated circuit (U5) should amplify and detect the AM radio waves all around you. The variable capacitor (CV) can be tuned to the desirable station. Varying the adjustable resistor (RV) will make the audio louder or softer. The power amplifier IC (U4) drives the speaker (SP) to complete the AM radio project.

Project #243 Fire Engine Symphony

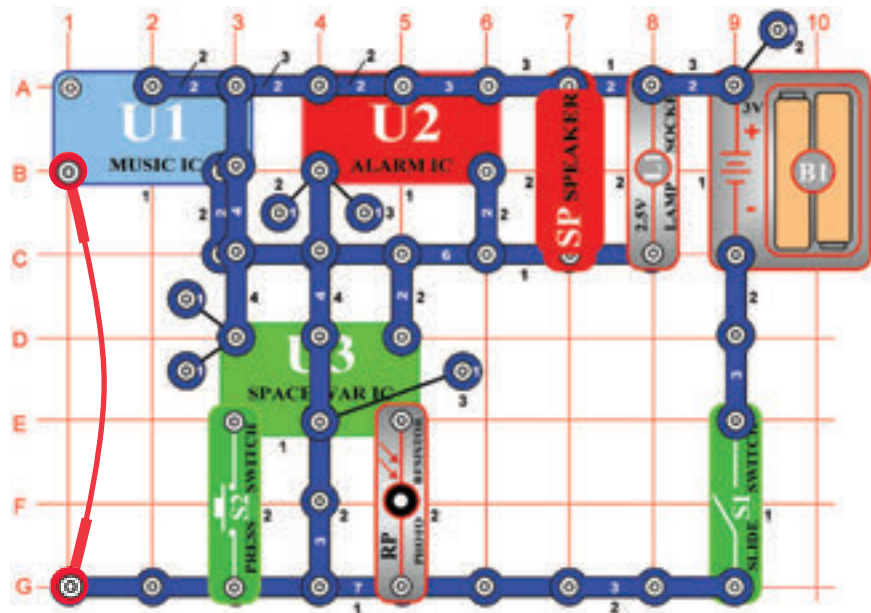

OBJECTIVE: To combine sounds from the music, alarm, and space war integrated circuits.

Build the circuit shown and add the jumper to complete it. Note that in two places two single snaps are stacked on top of each other. Also, note that there is a 2-snap wire on layer 2 that does not connect with a 4-snap wire that runs over it on layer 4 (both touch the music IC, U1). Turn it on and press the press switch (S2) several times and wave your hand over the photoresistor (RP) to hear the full spectrum of sounds that this circuit can create. Have fun!

Project #244 Fire Engine Symphony (II)

OBJECTIVE:
See project #243.

The preceding circuit may be too loud, so replace the speaker (SP) with the whistle chip (WC).

Can you guess why the jumper is used in this circuit? It is being used as just a 6-snap wire, because without it you don't have enough parts to build this complex circuit.

Project #245

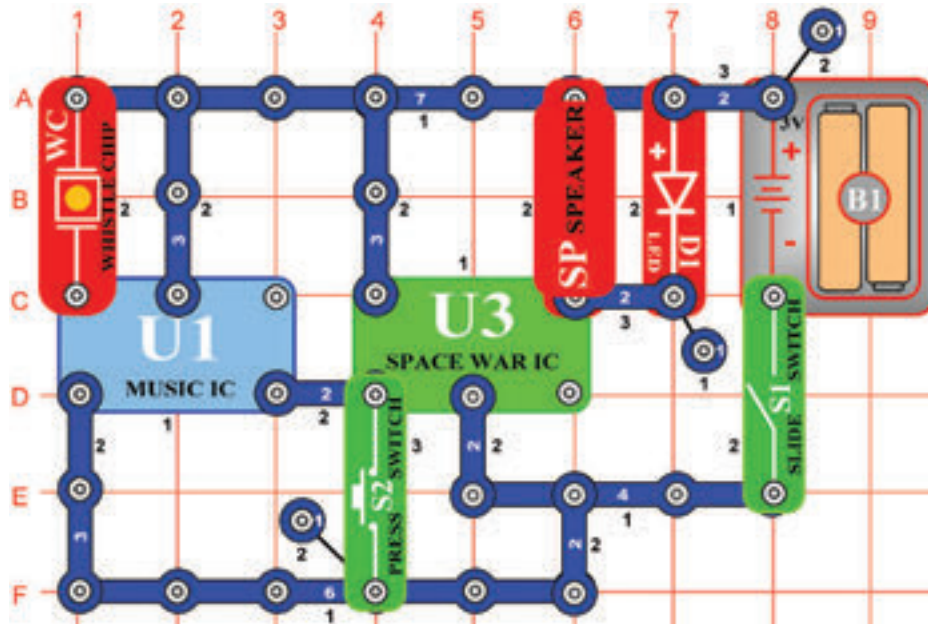

Vibration or Sound Indicator

OBJECTIVE: To build a circuit that is activated by vibration or sound.

Turn on the slide switch (S1), the war sounds start playing and the LED (D1) flashes. When all of the sounds are played, the circuit stops. Clap your hands next to the whistle chip (WC) or tap on it. Any loud sound or vibration causes the whistle chip to produce a small voltage, which activates the circuit. You can repeat a sound by holding down the press switch (S2) while it is playing.



Project #246

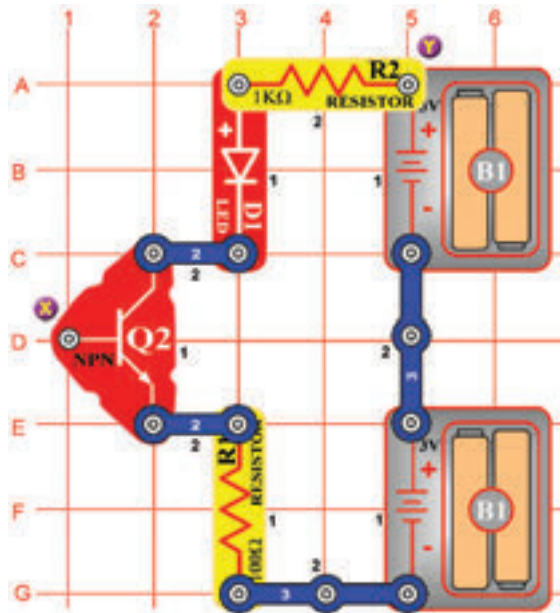

Two-Finger Touch Lamp

OBJECTIVE: To show that your body can be used as an electronic component.

Build the circuit on the left. You're probably wondering how it can work, since one of the points on the NPN transistor (Q2) is unconnected. It can't, but there is another component that isn't shown. That component is you.

Touch points X & Y with your fingers. The LED (D1) may be dimly lit. The problem is your fingers aren't making a good enough electrical contact with the metal. Wet your fingers with water or saliva and touch the points again. The LED should be very bright now. Think of this circuit as a touch lamp since when you touch it, the LED lights. You may have seen such a lamp in the store or already have one in your home.



Project #247

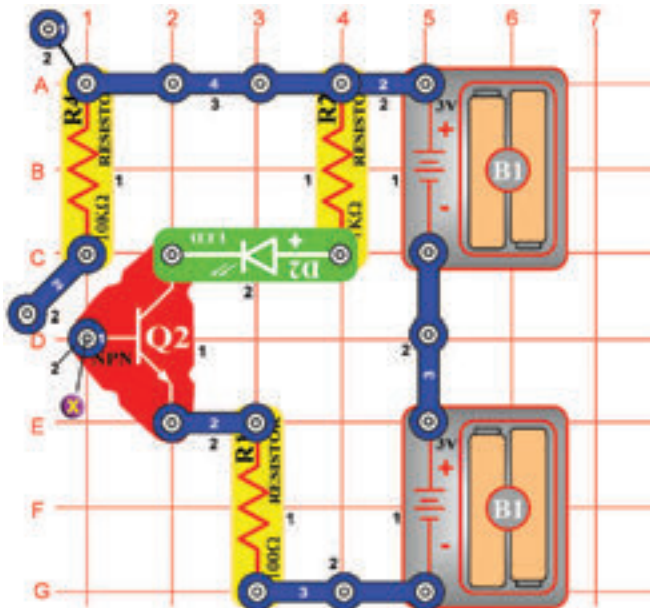

One-Finger Touch Lamp

OBJECTIVE: To show you how finger touch lamps work.

The touch lamps you see in stores only need to be touched by one finger to light, not two. So let's see if we can improve the last circuit to only need one finger. Build the new circuit, note that near point X there is a 2-snap wire that is only mounted on one side, swing it so the plastic touches point X. Wet a large area of one of your fingers and touch it to both metal contacts at point X at the same time; the LED (D2) lights. To make it easier for one finger to touch the two contacts, touch lamps or other touch devices will have the metal contacts interweaved as shown below and will also be more sensitive so that you don't have to wet your finger to make good contact.

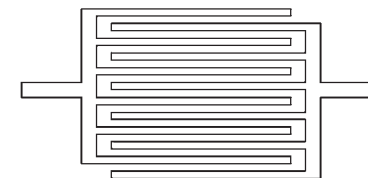

Project #248

Space Battle

Project #249 Space Battle (II)

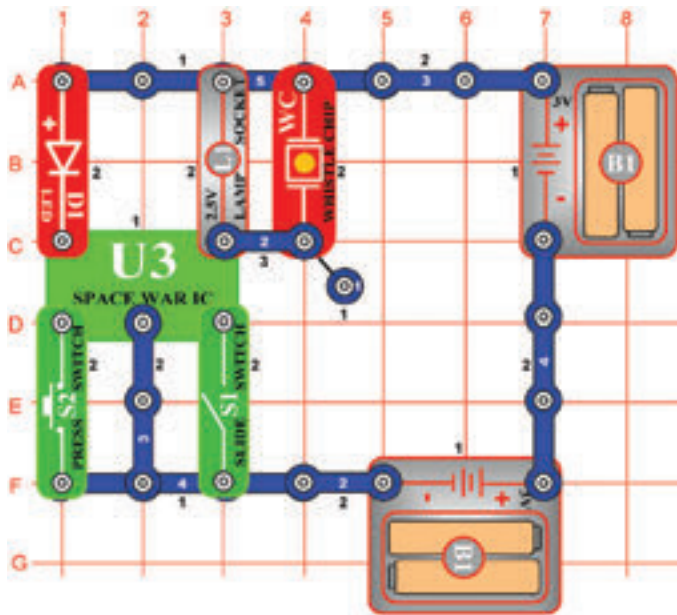

OBJECTIVE: To show how sound can turn “ON” an electronic device.

Build the circuit shown on the left. Activate the circuit by turning on the slide switch (S1) or pressing the press switch (S2), do both several times and in combination. You will hear exciting sounds and see flashing lights, as if a space battle is raging!

OBJECTIVE: To show how light can turn “ON” an electronic device.

Replace the slide switch (S1) with the photoresistor (RP). Now covering and uncovering the photoresistor will change the sound.

Project #250 Multi-Speed Light Fan

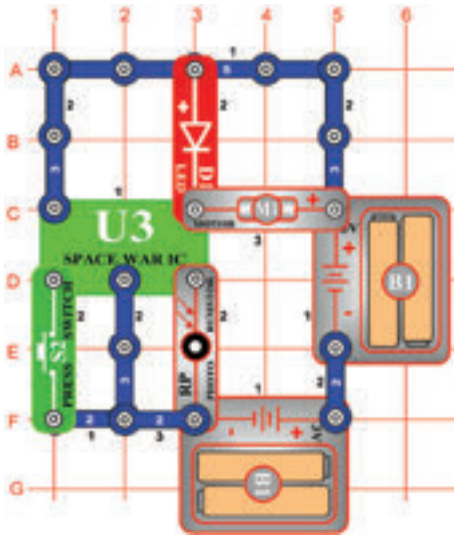

OBJECTIVE: To vary the speed of a fan activated by light.

Build the circuit shown on the left, with the fan on the motor (M1).

This circuit is activated by light on the photoresistor, (RP) though the fan will barely turn at all. Press the press switch (S2) and the fan will spin. If you hold the press switch down, the fan will spin faster. If you cover the photoresistor, the fan will stop unless the press switch is pressed.



WARNING: Moving parts. Do not touch the fan or motor during operation.

Project #251 Light & Finger Light

OBJECTIVE: To show another way the Space War IC may be used.

In the circuit at left, replace the motor (M1) with the 2.5V lamp (L1) shown below. Vary the brightness of the lamp by covering the photoresistor (RP) and holding down the press switch (S2) in various combinations. Notice that pressing the press switch when the photoresistor is covered still turns on the lamp, while in project #250, doing this would turn off the motor.





Project #252

Storing Electricity

OBJECTIVE: To store electricity in a capacitor.

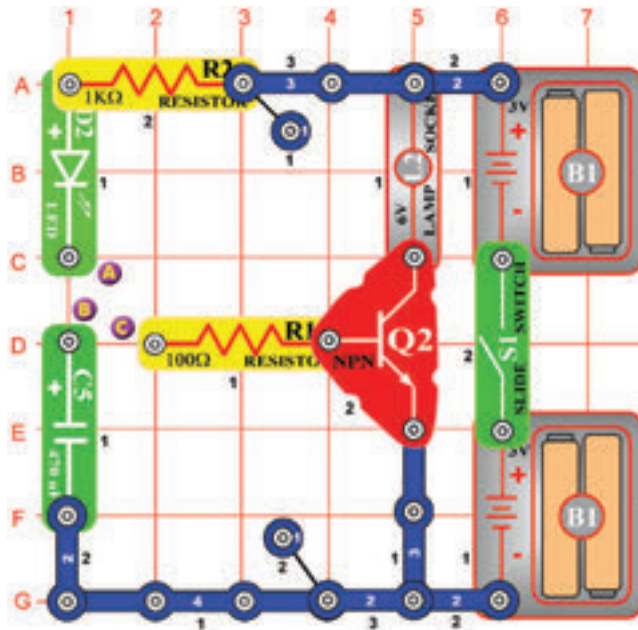

Turn the slide switch (S1) on and connect points A & B with a 2-snap wire. The green LED (D2) will flash and the 470µF capacitor (C5) will be charged with electricity. The electricity is now stored in the capacitor. Disconnect points A & B. Connect points B & C and there will be a flash from the 6V lamp (L2).
The capacitor discharges through the resistor to the base of the NPN transistor (Q2). The positive current turns on the transistor like a switch, connecting the lamp to the negative (-) side of the batteries. The light will go out after the capacitor discharges, because there is no more current at the base of the transistor.



Project #253 Lamp Brightness Control

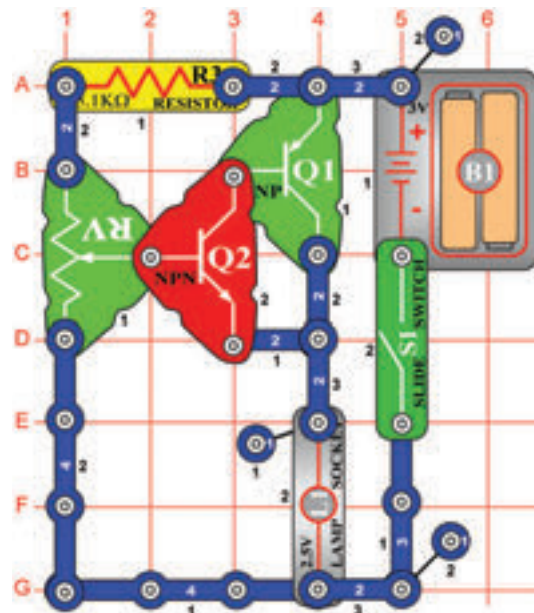

OBJECTIVE:
To use a transistor combination to control a lamp.

Here is a combination with two transistors. This combination increases the amplifying power. By changing the resistance, the current at the base of the transistor is also changed. With this amplifying ability of the combination, there is a greater change of current to the lamp (L1). This changes the brightness.



Project #254 Electric Fan

OBJECTIVE: To make an electric fan using a transistor circuit.

Use the circuit from project #253. Replace the lamp (L1) with the motor (M1) and install the fan. By controlling the adjustable resistor (RV), the speed of the fan changes. Now you can make your own speed changing electric fan.

WARNING: Moving parts. Do not touch the fan or motor during operation.



Project #255

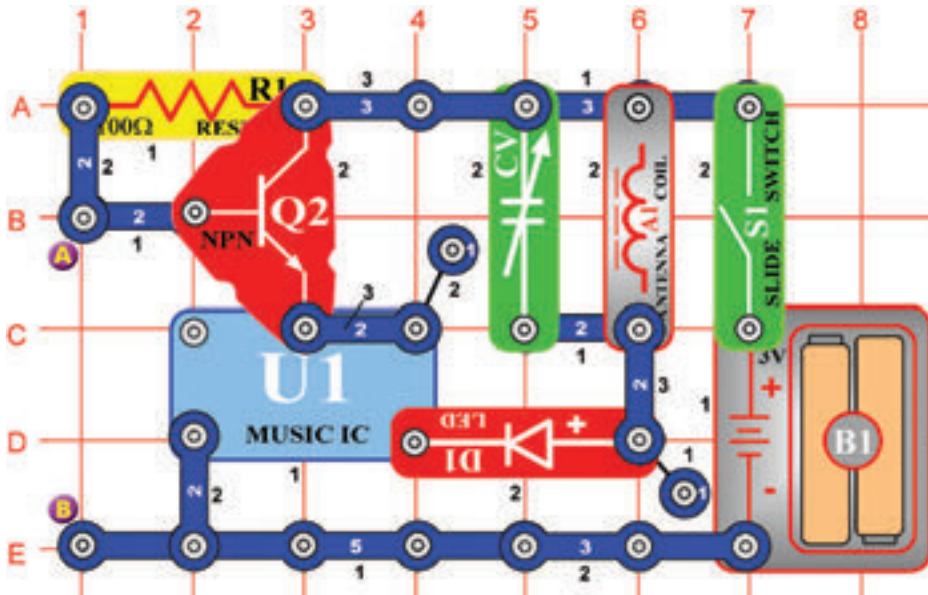

Radio Music Burglar Alarm

OBJECTIVE: To build an alarm that plays music on the radio.

Place the circuit next to an AM radio. Tune the radio so no stations are heard. Set the slide switch (S1) on. You should hear the song play. The red LED (D1) should also be lit. Adjust the variable capacitor (CV) for the loudest signal.

Connect a jumper wire across points A & B and the music stops. The transistor (Q2) acts like a switch connecting power to the music IC (U1). Positive voltage on the base turns on the switch and negative voltage opens it. Connect a string to the jumper wire and the other end of the string to a door or window. Turn the slide switch on. If a thief comes in through the door or window, the string pulls the jumper off and the music plays on the radio.



Project #256

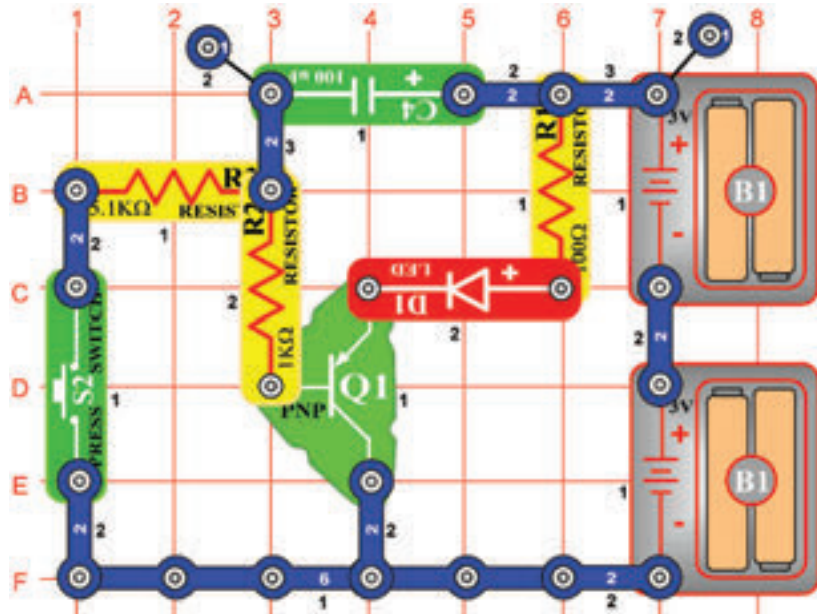

Light Dimmer

OBJECTIVE: To build a light dimmer.

Press the press switch (S2) to complete the current's path flow. You might expect the LED (D1) to light instantly but it doesn't. The charging current flows into the 100µF capacitor (C4) first. As the capacitor charges, the charging current decreases, input current to the PNP transistor (Q1) increases. So current begins to flow to the LED and the LED gradually brightens.

Now release the press switch. The capacitor begins to discharge, sending input current to the transistor. As the capacitor discharges, the input current reduces to zero and gradually turns off the LED and the transistor.



Project #257

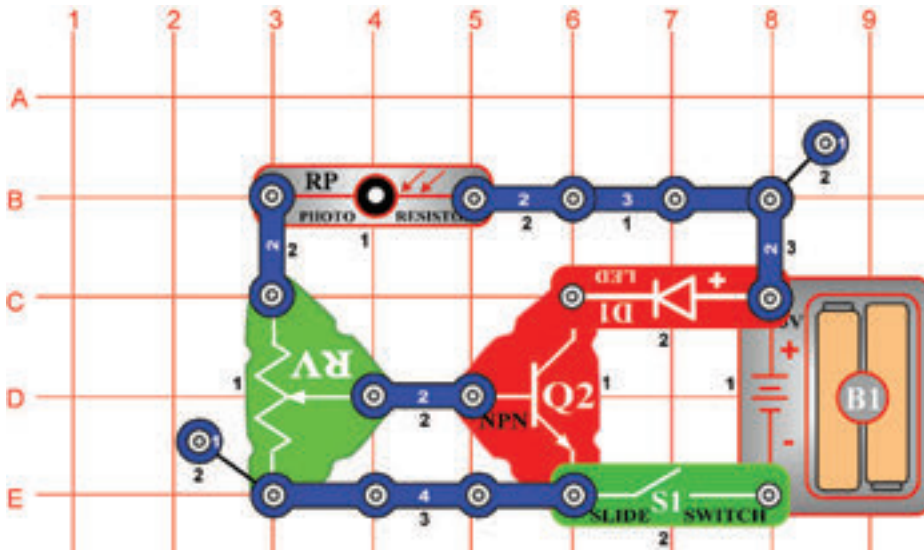

Motion Detector

OBJECTIVE: Build a circuit that detects motion.

Set the adjustable resistor (RV) to the center position. Turn the slide switch (S1) on and the LED (D1) lights. Wave your hand over the photoresistor (RP) and the LED turns off and on. The resistance changes as the amount of light strikes the photoresistor. As the light decreases, the resistance increases. The increased resistance lowers the voltage at the base of the NPN transistor (Q2). This turns off the transistor, preventing current flowing through the LED to the negative (-) side of the battery (B1). Wave your hand over photoresistor at different distances. The LED gets brighter the farther away your hand is.



Project #258

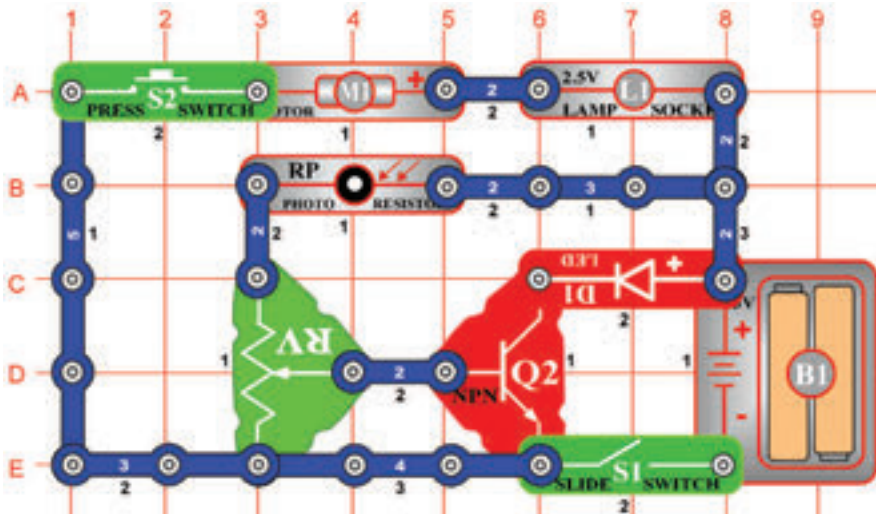

Fan Modulator

OBJECTIVE: To modulate the brightness of an LED.

Using the fan outline as a guide, cut a 3" circle out of a piece of paper. Then, cut a small triangle in it as shown. Tape the circle onto the fan and then place it onto the motor (M1). Set the adjustable resistor (RV) to the center position and turn the slide switch (S1) on. Press the press switch (S2), the fan spins and the lamp (L1) lights. As the triangle opening moves over the photoresistor (RP), more light strikes it. The brightness of the LED changes, or is *modulated*. As in AM or FM radio, modulation uses one signal to modify the amplitude or frequency of another signal.

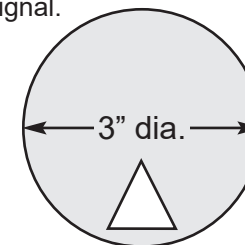

WARNING: Moving parts. Do not touch the fan or motor during operation.

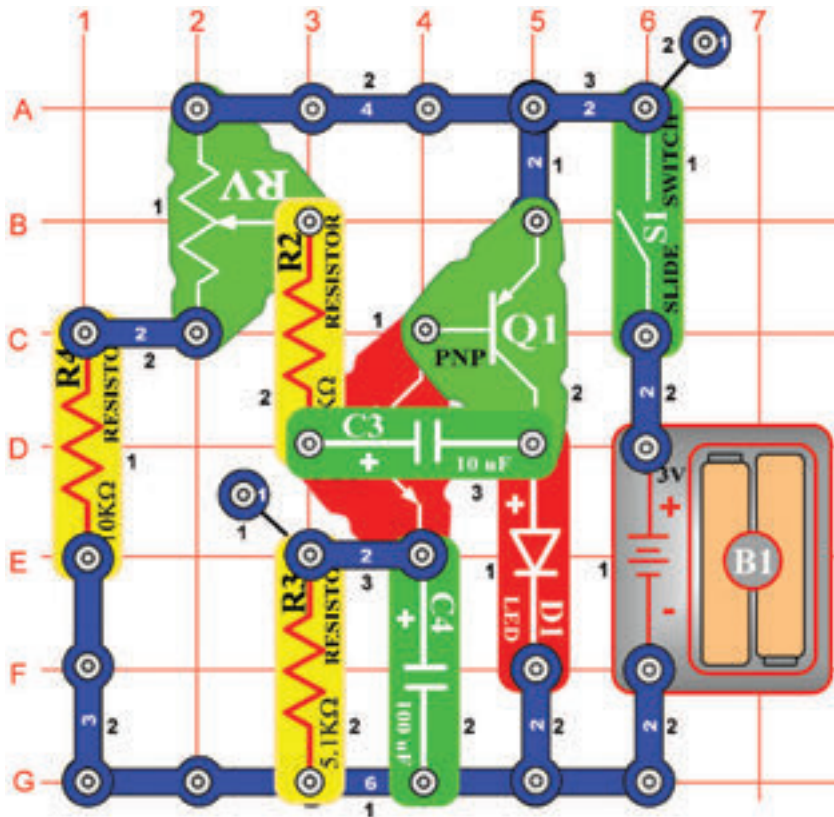

Project #259 Oscillator 0.5 - 30Hz

OBJECTIVE: To build a 0.5Hz - 30Hz oscillator that will light an LED.

Set the adjustable resistor (RV) to the bottom position and then turn the slide switch (S1) on. The LED (D1) will start flashing at a frequency of 0.5Hz (once every two seconds). Slowly adjust the adjustable resistor and the LED flashes faster. As the frequency increases, the LED flashes faster. Eventually, the LED flashes so fast, it looks like it is on all of the time.



Project #260 Sound Pulse Oscillator

OBJECTIVE: To build a 0.5Hz - 30Hz oscillator and hear it on a speaker.

Use the circuit from project #259.

Connect a single snap under the speaker (SP) and then connect it across the LED (on level 4). Turn the slide switch (S1) on and now you can hear the oscillator. Adjust the adjustable resistor (RV) to hear the different frequencies. Now you can hear and see the frequencies. Note: You may not hear sounds at all settings of the adjustable resistor.



Project #261

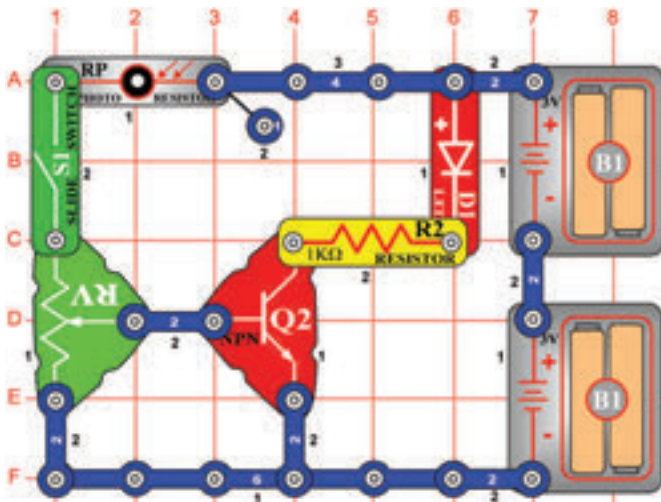

Motion Detector (II)

OBJECTIVE: To build a motion detector that senses an objects movement.

Turn the slide switch (S1) on and move the adjustable resistor (RV) control all the way up. The brightness of the LED (D1) is at maximum. Now, move the adjustable resistor control down until the LED goes out. Set the control up a little and the LED lights dimly.

Move your hand from side to side over the photoresistor (RP). As your hand blocks the light, the LED goes out.

The amount of light changes the resistance of the photoresistor and the current flow to the base of the NPN transistor (Q2). The transistor acts like a switch. Its base current is supplied through the photoresistor. As the base current changes, so does the current flow through the LED. With no base current, the LED goes out.

Project #262

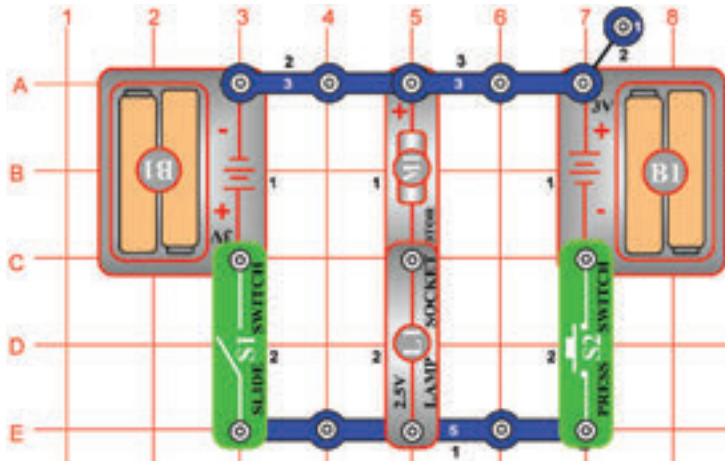

Motor Rotation

OBJECTIVE: To show how voltage polarity affects a DC motor.

Place the fan onto the motor (M1). Press the press switch (S2). The fan rotates clockwise. When you connect the positive (+) side of the battery (B1) to the positive (+) side of the motor, it spins clockwise. Release the press switch and turn on the slide switch (S1). Now the fan spins the other way. The positive (+) side of the battery is connected to the negative (-) side of the motor. The polarity on the motor determines which way it rotates. Notice that the lamp (L1) lights in both polarities. It is not effected by the polarity changes.



WARNING: Moving parts. Do not touch the fan or motor during operation.



WARNING: Do not lean over the motor.

Project #263

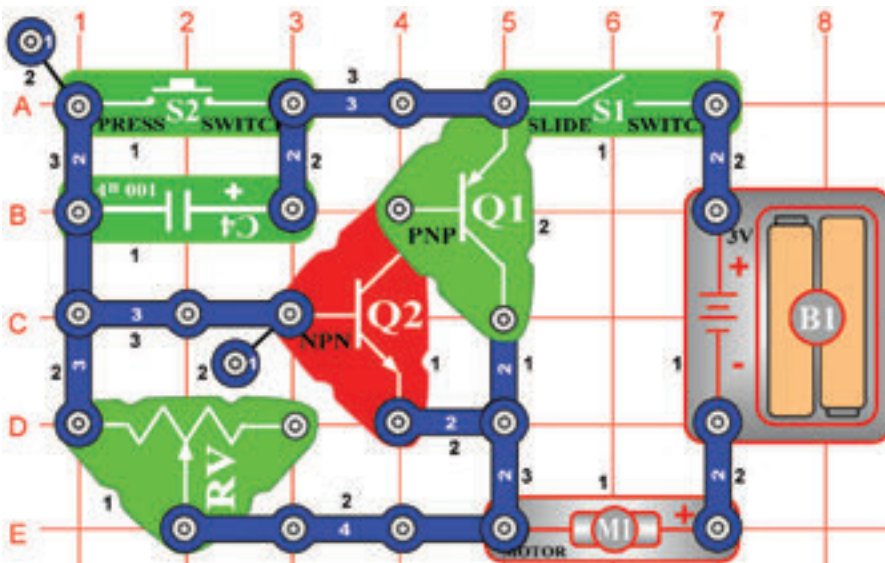

Motor Delay Fan

OBJECTIVE: To build a circuit that controls how long the fan is on.

Place the fan onto the motor (M1) and set the adjustable resistor (RV) control to the far right. Turn the slide switch (S1) on and then press the press switch (S2) once. The motor will spin and then stop. Now set the resistor control to the far left and press the press switch again. The time the fan spins is much less now.

When the press switch is pressed, the current flows through the circuit and the fan spins. The 100µF capacitor (C4) charges up also. When the press switch is released, the capacitor discharges and supplies the current to keep the transistors (Q1 & Q2) on. The transistor acts like a switch connecting the fan to the battery. When the capacitor fully discharges, the transistors turn off and the motor stops. The adjustable resistor controls how fast the capacitor discharges. The more resistance, the longer the discharge time.



WARNING: Moving parts. Do not touch the fan or motor during operation.

Project #264 Motor Delay Fan (II)

OBJECTIVE: To change capacitance to affect time.

Use the circuit from project #263. Connect a single snap under the positive (+) side of the 470µF capacitor (C5) and then connect it over the top of the 100µF capacitor (C4). Turn the slide switch (S1) on and press the press switch (S2). Notice that the fan spins longer now. When capacitors are in parallel, the values are added, so now you have 570µF. The time it takes to discharge the capacitors is longer now, so the fan keeps spinning.



Project #265

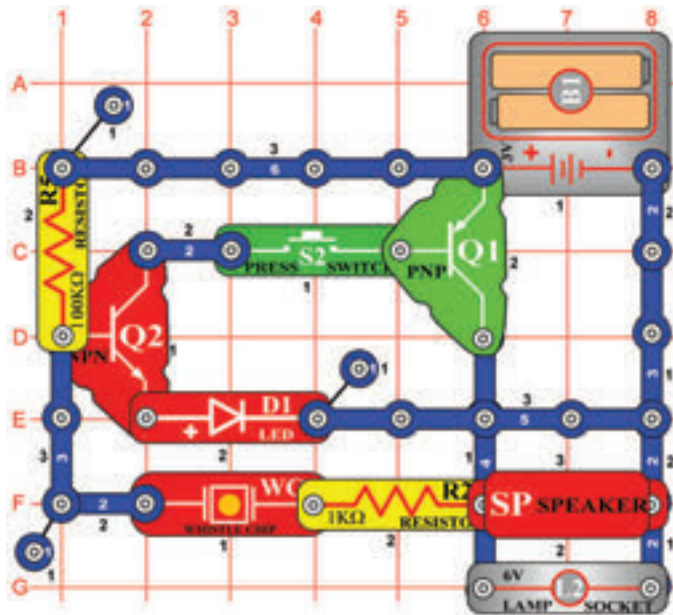

High Pitch Bell

OBJECTIVE: To build a high pitch bell.

Build the circuit shown and press the press switch (S2). The circuit starts to oscillate. This generates the sound of a high pitch bell.



Project #266 Steamboat Whistle

OBJECTIVE: To build a steamboat whistle.

Using the circuit in project #265, connect the 0.02μF capacitor (C1) across the whistle chip (WC). Press the press switch (S2). The circuit now generates the sound of a steamboat.



Project #267 Steamship

OBJECTIVE: To generate the sound of a steamship.

Using the circuit in Project #265, connect the 0.1μF capacitor (C2) across the whistle chip. Press the press switch (S2). The circuit now generates the sound of a steamship.



Project #268

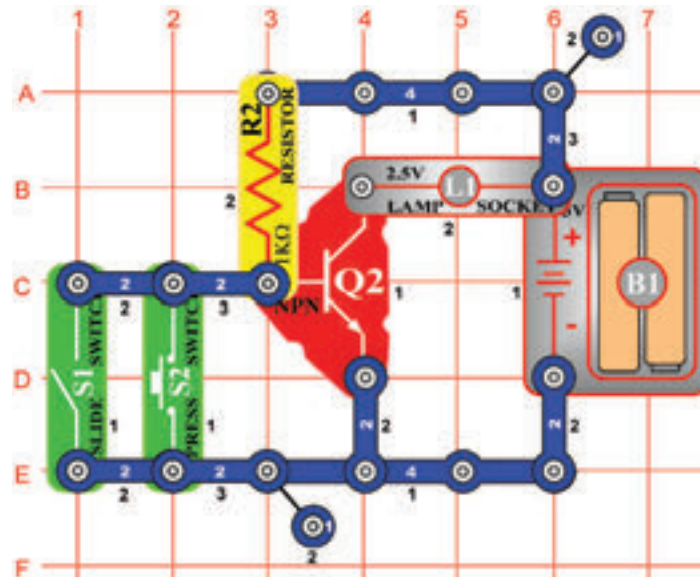

Light NOR Gate

OBJECTIVE: To build a NOR gate.

Build the circuit on the left. You will find that the lamp (L1) is on when neither the slide switch (S1) NOR the press switch (S2) are on. This is referred to as an NOR gate in electronics and is important in computer logic.

Example: If neither condition X NOR condition Y are true, then execute instruction Z.



Project #269

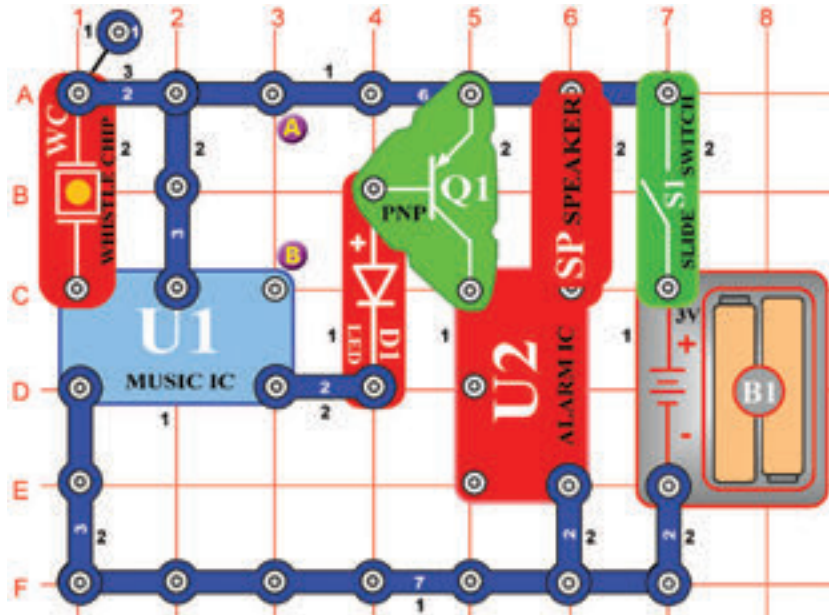

Noise-Activated Burglar Alarm

OBJECTIVE: To build a noise activated alarm.

Turn the slide switch (S1) on and wait for the sound to stop. Place the circuit into a room you want guarded. If a thief comes into the room and makes a loud noise, the speaker (SP) will sound again.

If you find that the sound does not turn off, then vibrations created by the speaker may be activating the whistle chip. Set the speaker on the table near the circuit and connect it to the same locations using the jumper wires to prevent this.



Project #270 Motor-Activated Burglar Alarm

OBJECTIVE: To build a motor-activated burglar alarm.

Use the circuit from project #269 shown above. Replace the whistle chip (WC) with the motor (M1). Wind a piece of string around the axis of the motor so when you pull it the axes spins. Connect the other end of the string to a door or window. Turn the slide switch (S1) on and wait for the sound to stop. If a thief comes in through the door or window the string pulls and the axes spins. This will activate the sound.



Project #271 Light-Activated Burglar Alarm

OBJECTIVE: To build a light-activated burglar alarm.

Use the circuit from project #269 shown above. Connect a photoresistor (RP) across points A & B and cover it or turn off the lights. Turn the slide switch (S1) on and wait for the sound to stop. At night, when the thief comes in and turns on the light, the speaker (SP) makes the sound of a machine gun.

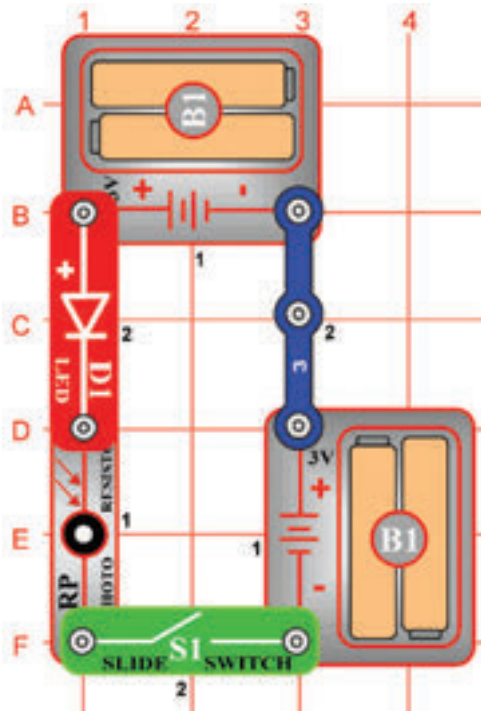

Project #272 Photoresistor Control

OBJECTIVE: To use a photoresistor to control the brightness of an LED.

In this circuit, the brightness of the LED (D1) depends on how much light shines directly on the photoresistor (RP). If the photoresistor were held next to a flashlight or other bright light, then the LED would be very bright.

The resistance of the photoresistor decreases as more light shines on it. Photoresistors are used in applications such as streetlamps, which come on as it gets dark due to night or a severe storm.

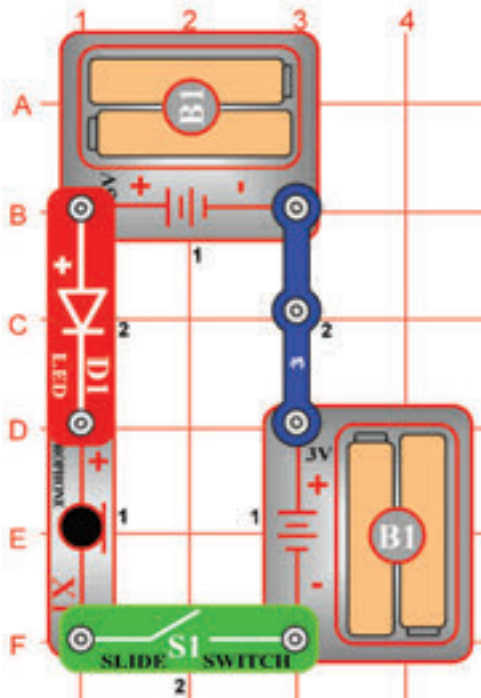

Project #273 Microphone Control

OBJECTIVE: To use a microphone to control the brightness of an LED.

In this circuit, blowing on the microphone (X1) changes the LED (D1) brightness.

The resistance of the microphone changes when you blow on it. You can replace the microphone with one of the resistors to see what resistor value it is closest to.

Project #274 Pressure Alarm

OBJECTIVE: To build a pressure alarm circuit.

Connect two jumper wires to the whistle chip (WC) as shown. Set the control of the adjustable resistor (RV) to the far left and turn on the switch. There is no sound from the speaker (SP) and the LED (D1) is off. Tap the center of the whistle chip. The speaker sounds and the LED lights. The whistle chip has a piezocrystal between the two metal plates. The sound causes the plates to vibrate and produce a small voltage. The voltage is amplified by the power amplifier IC (U4), which drive the speaker and LED.

Place a small object in the center of the whistle chip. When you remove the object the speaker and LED are activated. In alarm systems, a siren would sound to indicate the object has been removed.

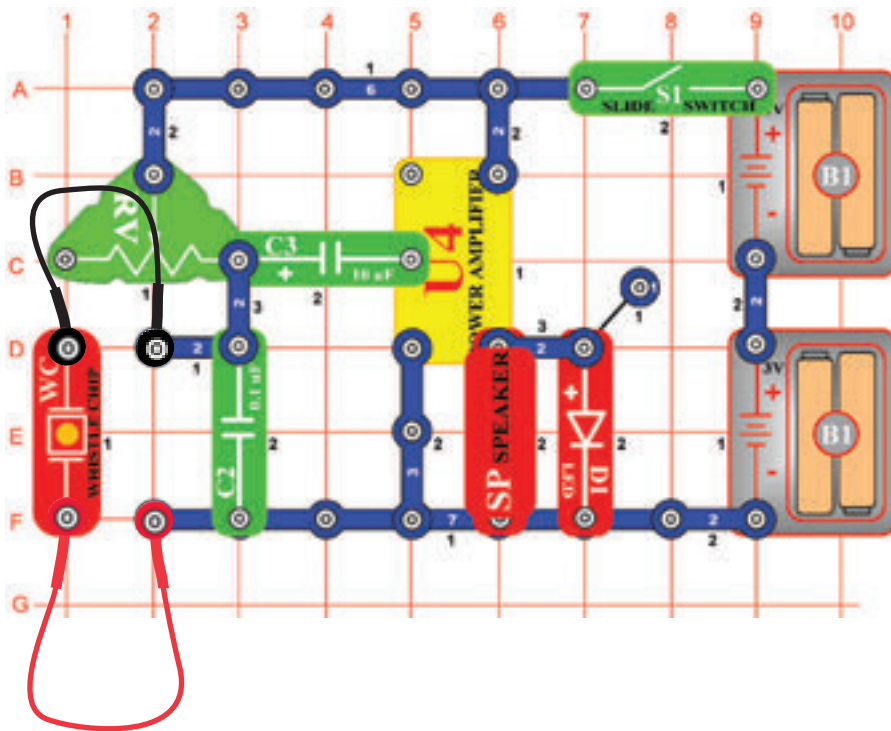

Project #275 Power Microphone

OBJECTIVE: To build a power microphone.

Use the circuit from project #274.

Replace the whistle chip with the microphone (X1), and hold it away from the speaker (SP). Set the control of the adjustable resistor (RV) to the far left. Turn on the slide switch (S1) and talk into the microphone. You now hear your voice on the speaker. The sound waves from your voice vibrate the microphone and produce a voltage. The voltage is amplified by the power amplifier IC (U4) and your voice is heard on the speaker.



Project #276

LED Fan Rotation Indicator

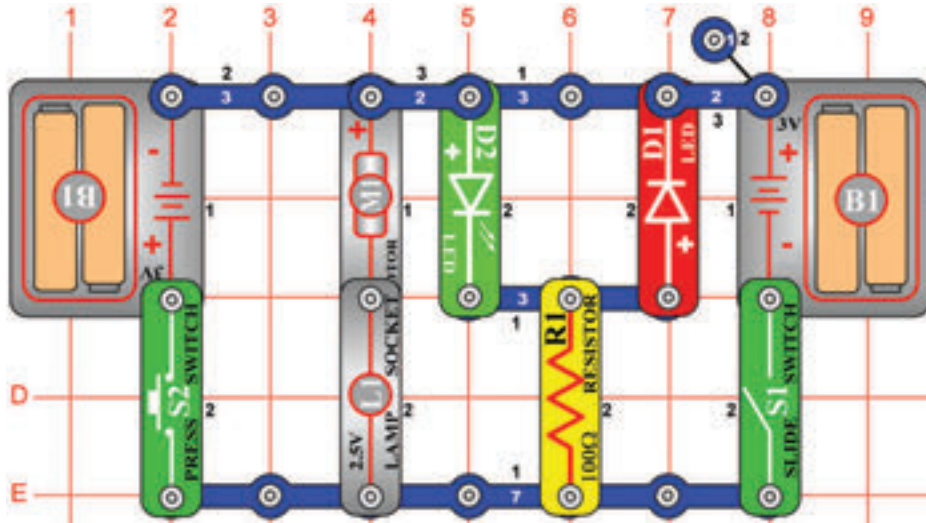

OBJECTIVE: To build an LED fan rotation indicator.

Place the fan onto the motor (M1). Turn the slide switch (S1) on. The fan rotates clockwise, the green LED (D2) and the lamp (L1) light. When you connect the positive (+) side of the battery (B1) to the positive (+) side of the motor, it spins clockwise. Turn the slide switch off and press the press switch (S2). Now the fan spins the other way and the red LED (D1) and lamp light. The positive (+) side of the battery is connected to the negative (-) side of the motor. The polarity on the motor determines which way it rotates. Notice that the lamp lights in both polarities.

WARNING: Moving parts. Do not touch the fan or motor during operation.



Project #277

Space War Sounds with LED

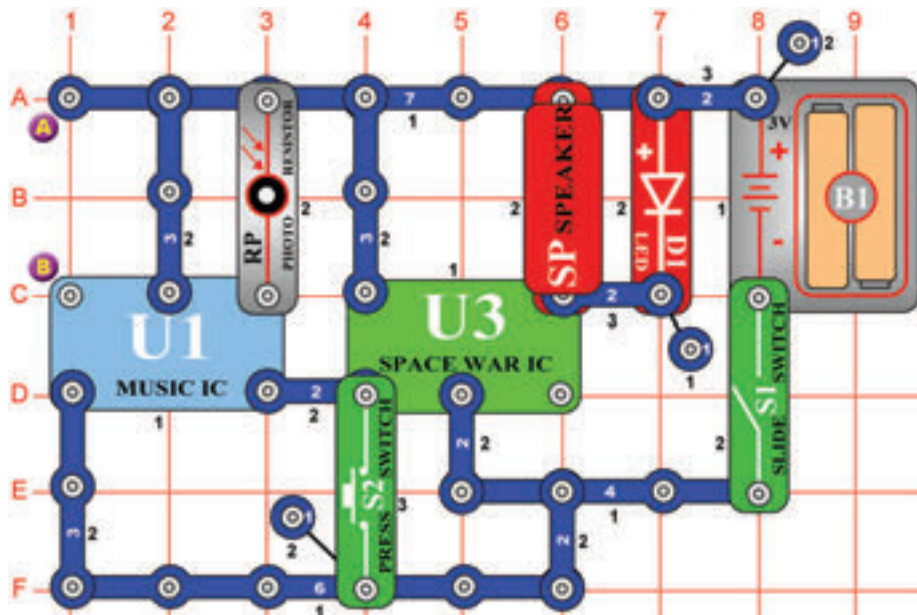

OBJECTIVE: To build a circuit that uses a programmed sound integrated circuit (IC).

Build the circuit shown on the left, which uses the space war integrated circuit (U3). Turn the slide switch (S1) on. A space war sound plays, and the LED (D1) flashes. If there is no light on the photoresistor (RP) then the sound will stop after a while.

You also make sounds by pressing the press switch (S2). See how many sounds are programmed into the space war sound IC.



Project #278

Sound Mixer

OBJECTIVE: To connect two sound IC's together.

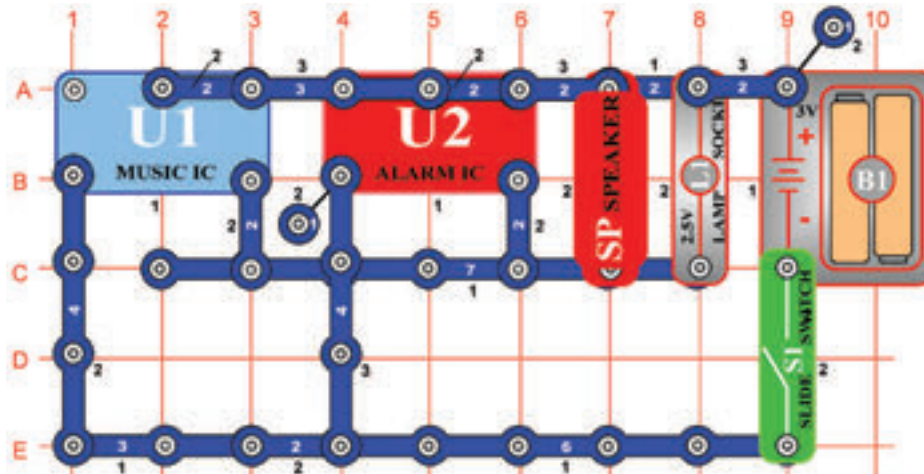

In the circuit, the outputs from the alarm (U2) and music (U1) IC's are connected together. The sounds from both IC's are played at the same time.



Project #279

Sound Mixer Fan Driver

OBJECTIVE: To connect two sound IC's together to drive two LED's and a motor.

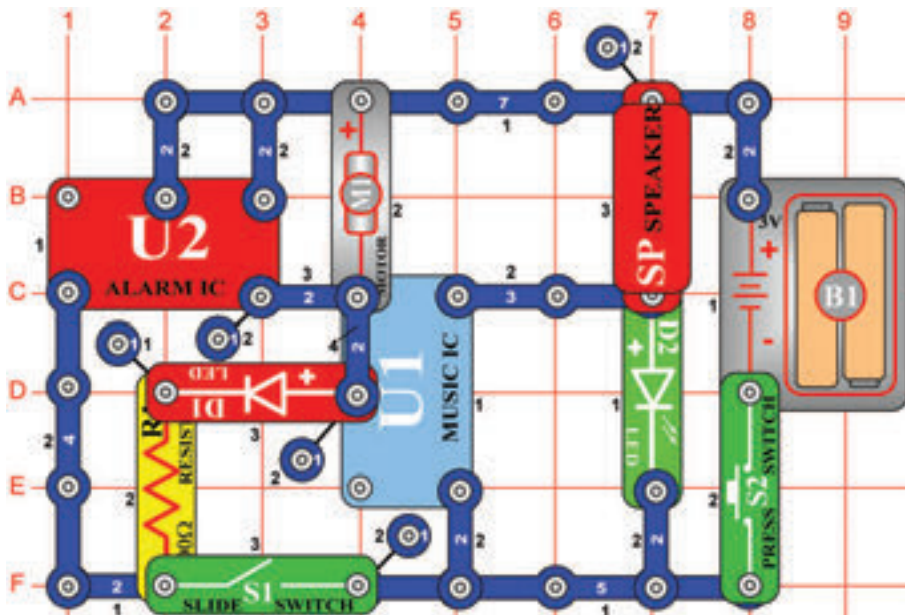

Build the circuit shown on the left. Place the fan onto the motor (M1). In the circuit, the alarm IC (U2) and the music IC (U1) are connected together. The sounds from both IC's can be played at the same time. Press the press switch (S2). The music IC plays and the green LED (D2) lights. Now turn on the slide switch (S1) and press the press switch again. You should hear the sounds from both IC's playing. As the alarm IC plays, it also drives the fan and the red LED (D1).

WARNING: Moving parts. Do not touch the fan or motor during operation.



Project #280

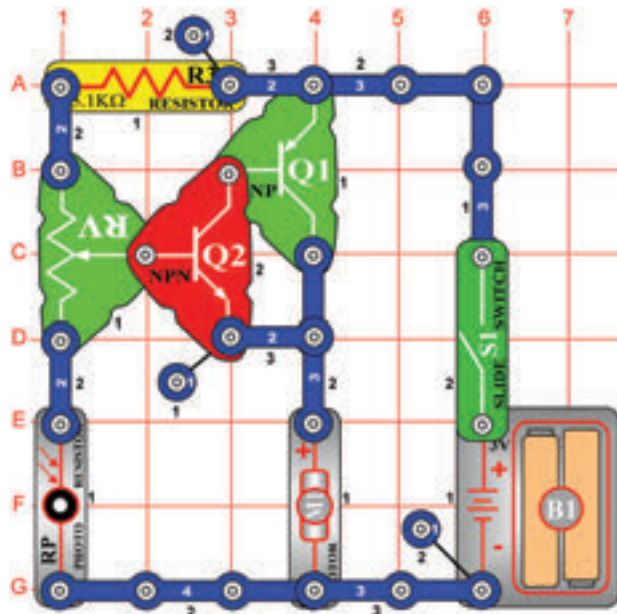

Electric Fan Stopped by Light

OBJECTIVE: To show how light can control a motor.

Turn on the slide switch (S1) and set the adjustable resistor (RV) control so the motor (M1) just starts spinning. Slowly cover the photoresistor (RP) and the motor spins faster. By placing more light over the photoresistor, the motor slows.

The fan will not move on most settings of the resistor, because the resistance is too high to overcome friction in the motor. If the fan does not move at any resistor setting, then replace your batteries.



WARNING: Moving parts. Do not touch the fan or motor during operation.



Project #281

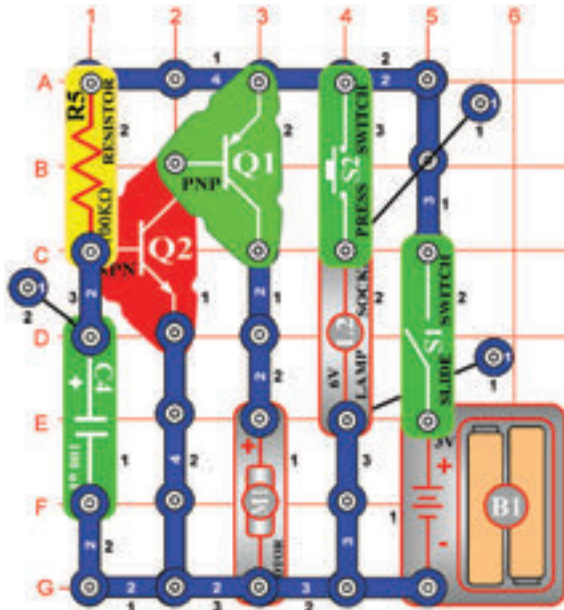

Motor & Lamp

OBJECTIVE: To control large currents with a small one.

Place the fan on the motor (M1). Turn on the slide switch (S1) and the motor spins. The transistors are like two switches connected in series. A small current turns on the NPN transistor (Q2), which turns on the PNP transistor (Q1). The large current used to spin the motor now flows through the PNP. The combination allows a small current to control a much larger one.

Press the press switch (S2) and the lamp (L2) lights and slows the motor. When the lamp lights, the voltage across the motor decreases and slows it down.

The fan will not move on most settings of the resistor, because the resistance is too high to overcome friction in the motor. If the fan does not move at any resistor setting, then replace your batteries.



WARNING: Moving parts. Do not touch the fan or motor during operation.



Project #282

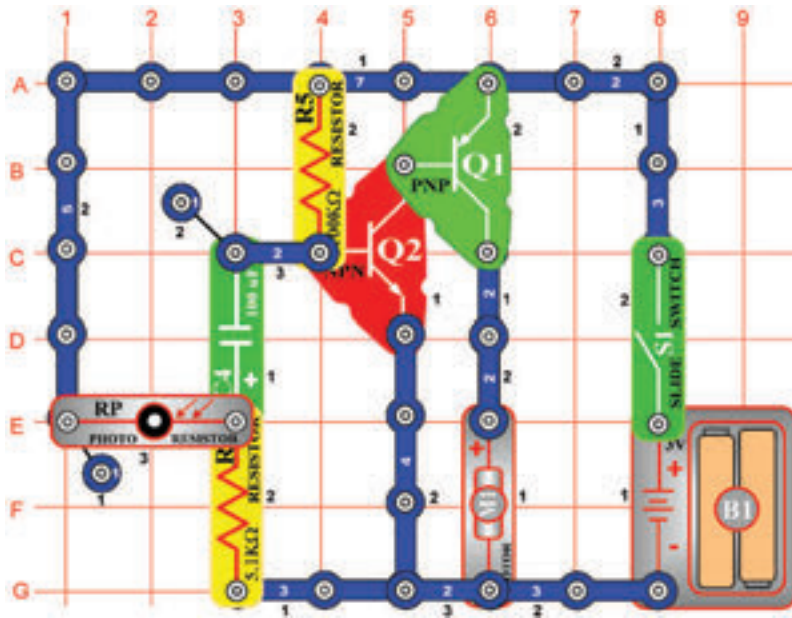

Start-Stop Delay

OBJECTIVE: To start and stop a motor with light.

Place the fan on the motor (M1). Turn on the slide switch (S1), the motor starts spinning. As you move your hand over the photoresistor, (RP) the motor slows. Now place a finger on top of the photoresistor to block the light. The motor slows down. In a few seconds the motor speeds up again.

The fan will not move on most settings of the resistor, because the resistance is too high to overcome friction in the motor. If the fan does not move at any resistor setting, then replace your batteries.



WARNING: Moving parts. Do not touch the fan or motor during operation.



Project #283

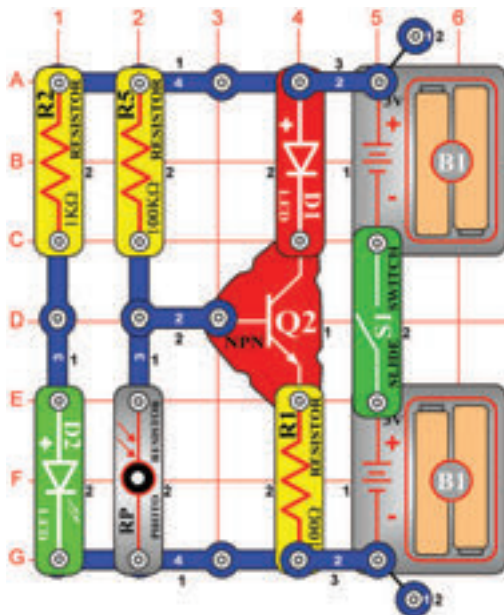

Mail Notifying System

OBJECTIVE: To build a circuit to indicate if you have mail.

Turn on the slide switch (S1). If there is light on the photoresistor (RP) the red LED (D1) will not light. Place your finger over the photoresistor and now the red LED lights. A simple mail notifying system can be made using this circuit. Install the photoresistor and the green LED (D2) inside the mailbox facing each other. Place the red LED outside the mailbox. When there is mail, the light is blocked from the photoresistor and the red LED turns on.

Project #284 Mail Notifying Electronic Bell

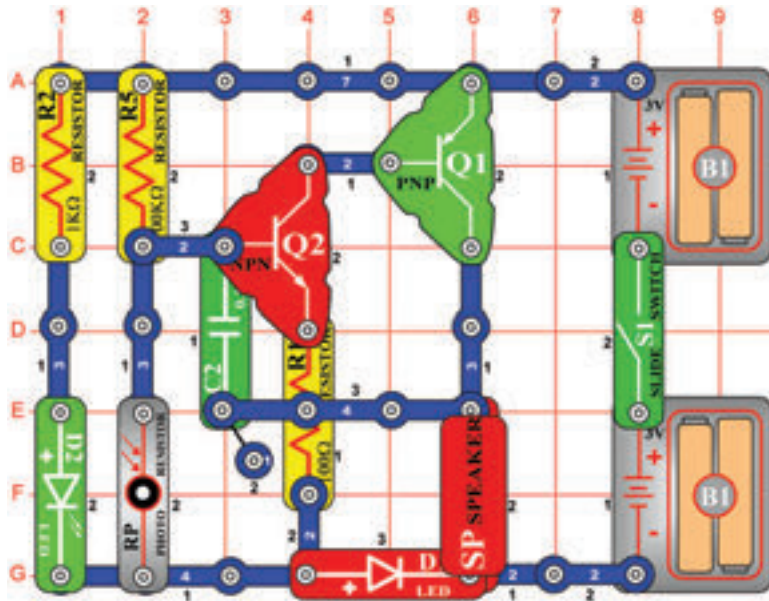

OBJECTIVE: To build a circuit to indicate if you have mail by sounding a tone.

Turn on the slide switch (S1). If there is enough light on the photoresistor (RP), the speaker (SP) will not make any sound. Place your finger over the photoresistor and now the speaker sounds. The sound will stay on until you turn off the slide switch. A simple mail notifying system can be made using this circuit. Install the photoresistor and the green LED inside the mailbox facing each other. When there is mail, the light is blocked from the photoresistor and the speaker turns on.

Project #285 Mail Notifying Electronic Lamp

OBJECTIVE: To build a circuit to indicate if you have mail by activating the lamp.

Replace the speaker (SP) with the lamp (L2). When there is mail, the light is blocked from the photoresistor (RP) and the lamp lights.

Project #286

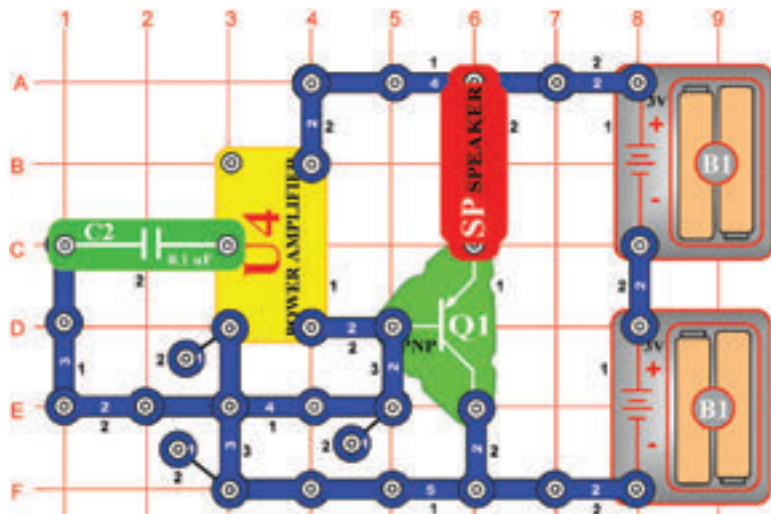

Twice-Amplified Oscillator

OBJECTIVE: To build an oscillating circuit.

The tone you hear is the frequency of the oscillator. Install different values of capacitors in place of the 0.1 μ F capacitor (C2) to change the frequency.

Project #287 Quick Flicking LED

OBJECTIVE: To build a flicking LED circuit.

Use the circuit from project #286. Replace the speaker (SP) with a red LED (D1, the "+" sign on top). Now you see the frequency of the oscillator. Install different values of capacitors to change the frequency.



Project #288

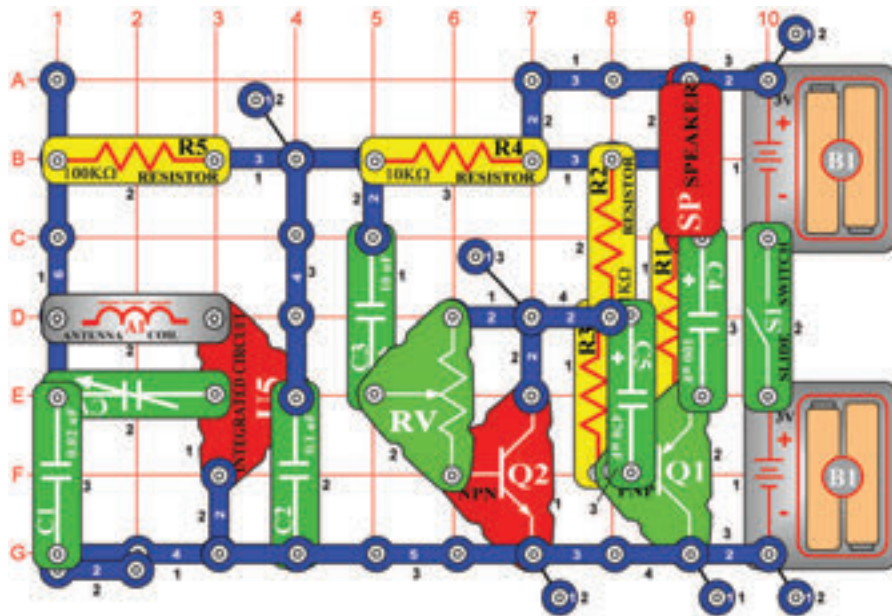

AM Radio with Transistors

OBJECTIVE: To build a complete, working AM radio with transistor output.

When you turn on the slide switch (S1), the integrated circuit (U5) should amplify and detect the AM radio waves. Tune the variable capacitor (CV) to the desirable station. Set the adjustable resistor (RV) for the best sound. The two transistors (Q1 & Q2) drive the speaker (SP) to complete the radio. The radio will not be very loud.



Project #289

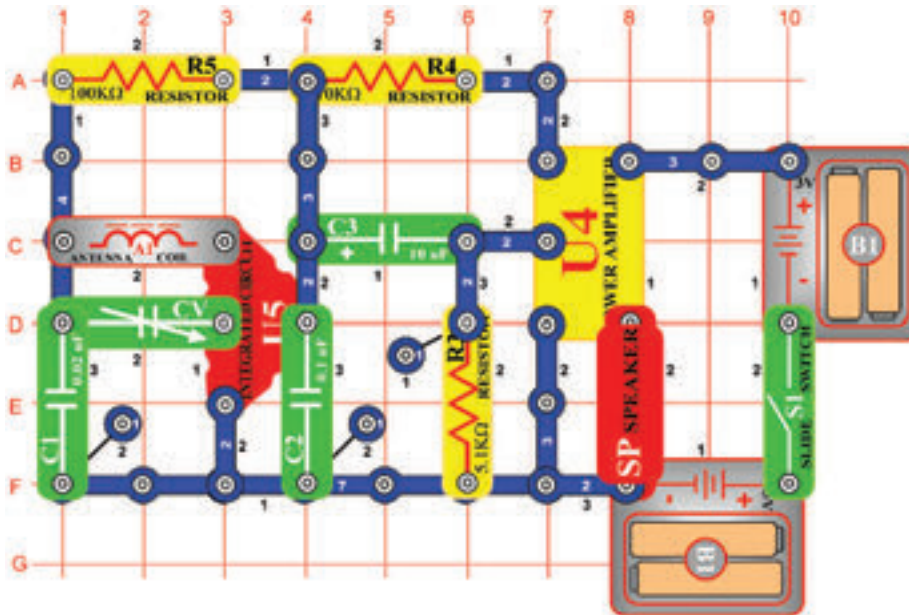

AM Radio (II)

OBJECTIVE: To build a complete, working AM radio.

When you close the slide switch (S1), the integrated circuit (U5) should detect and amplify the AM radio waves. The signal is then amplified using the power amplifier (U4), which drives the speaker (SP). Tune the variable capacitor (CV) to the desirable station.



Project #290

Music Amplifier

OBJECTIVE: To amplify sounds from the music integrated circuit.

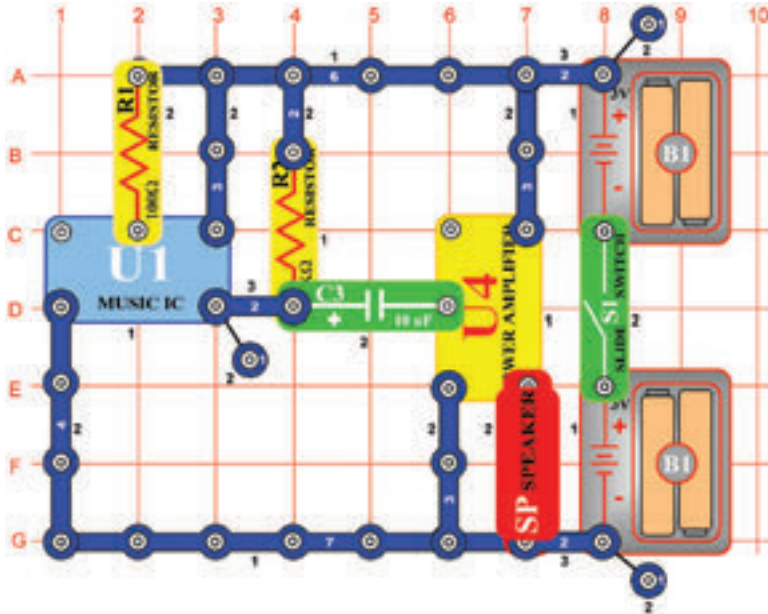

Build the circuit and turn on the slide switch (S1). You will hear loud music, since the sound from the music IC (U1) is amplified by the power amplifier IC (U4). All radios and stereos use a power amplifier.



Project #291 Delayed Action Lamp



Project #292 Delayed Action Fan

OBJECTIVE: To build a lamp that stays on for a while.

OBJECTIVE: To build a fan that stays on for a while.

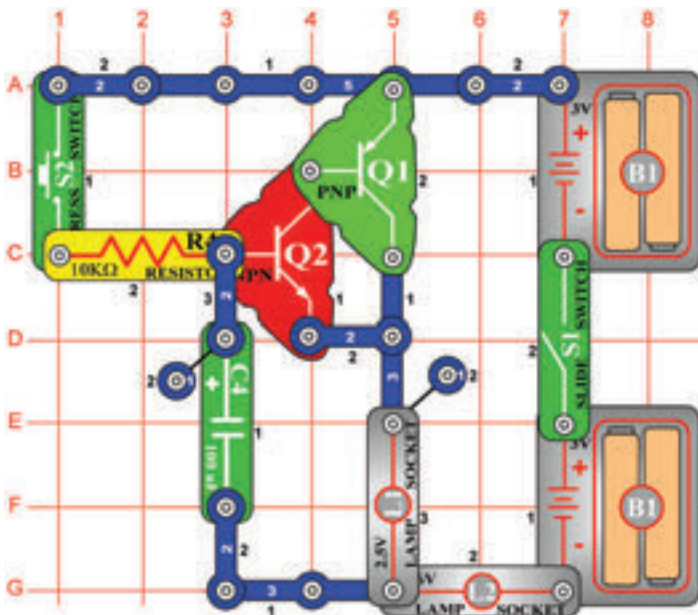

Turn on the slide switch (S1) and press the press switch (S2). The lamps (L1 & L2) turn on slowly, but stay on for a while after you release the press switch.

Replace the lamp (L1) with the motor (M1), positive (+) side up. Be sure to put on the fan. Turn on the slide switch (S1) and press the press switch (S2). The fan turns on slowly but stays on for a while after you release the press switch.



Project #293

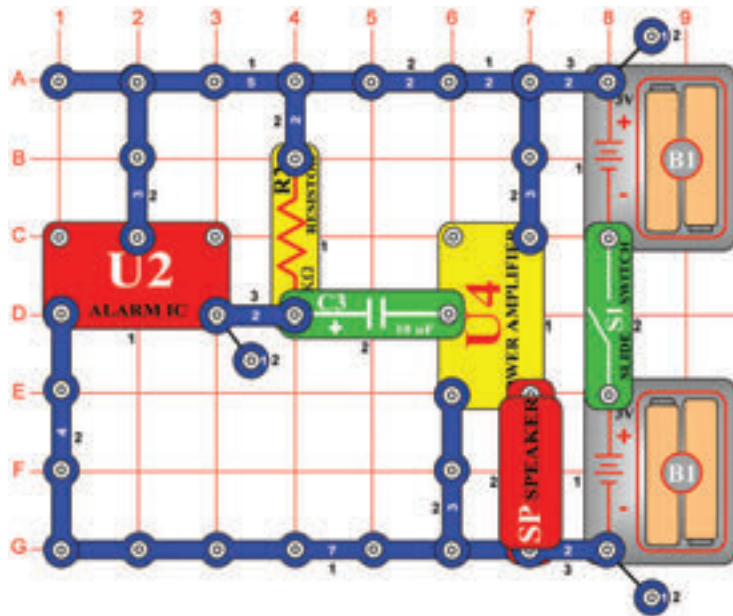

Police Siren Amplifier

OBJECTIVE: To amplify sounds from the music integrated circuit.

Build the circuit and turn on the slide switch (S1). You will hear a very loud siren, since the sound from the alarm IC (U2) is amplified by the power amplifier IC (U4). Sirens on police cars use a similar circuit, with an IC to create the sound and a power amplifier to make it very loud.



Project #294

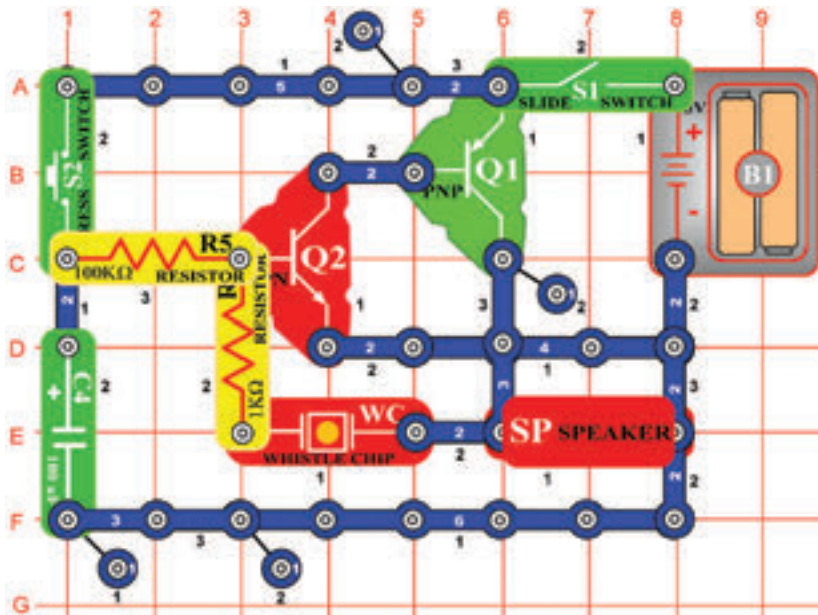

Lasting Doorbell

OBJECTIVE: To build a doorbell that stays on for a while.

Build the circuit at left, note that there is a 4-snap wire on layer 1 that is not connected to a 3-snap wire that runs over it on layer 3. Turn on the slide switch (S1), then press and release the press switch (S2). There is a doorbell sound that slowly fades away.

When the press switch is pressed, the transistors are supplied with current for oscillation. At the same time, the 100µF capacitor (C4) is being charged. When the press switch is released, the capacitor discharges and keeps the oscillation going for a while.



Project #295 Lasting Clicking

OBJECTIVE: To build a clicker that stays on for a while.

Place the 10µF capacitor (C3) on top of the whistle chip (WC). Press and release the press switch (S2). It makes a clicking sound that repeats for a while.



Project #296

Leaky Capacitor

OBJECTIVE: To show how capacitors can leak.

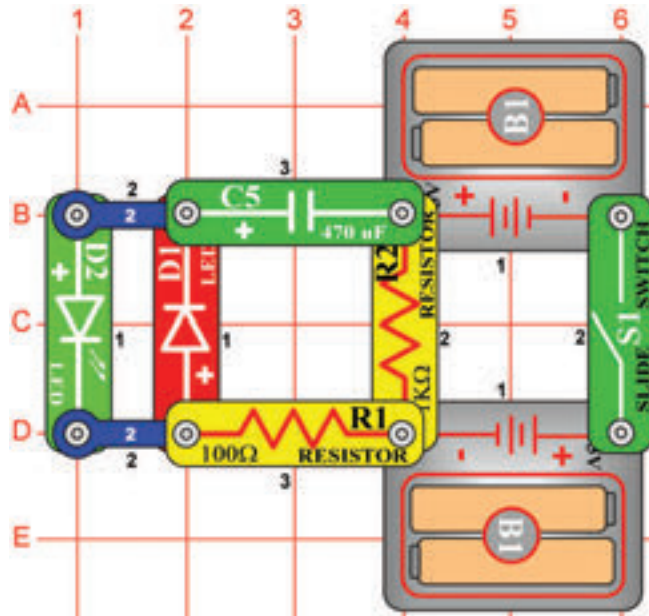

Build the circuit (be sure the positive (+) side of the capacitor is towards the left) and turn on the slide switch (S1). The green LED (D2) will flash brightly as the 470µF capacitor (C5) charges up and then becomes dim but will not be off. When you turn off the slide switch, the red LED (D1) is initially bright, but goes dim as the capacitor discharges itself through it.

Why doesn't the green LED go off after the capacitor becomes charged? It is because current is leaking through the 470µF capacitor.

The positive (+) side of the capacitor should normally be facing towards the higher voltage side, in this circuit we have it facing away from the batteries (B1). In most circuits this doesn't matter, but in this case it does.

Reverse the position of the capacitor (so the positive (+) side is on the right) and turn on the slide switch again. Now the green LED turns totally off after the capacitor gets charged up. It doesn't leak now.



Project #297 Transistor Fading Siren

OBJECTIVE: To build a siren that slowly fades away.

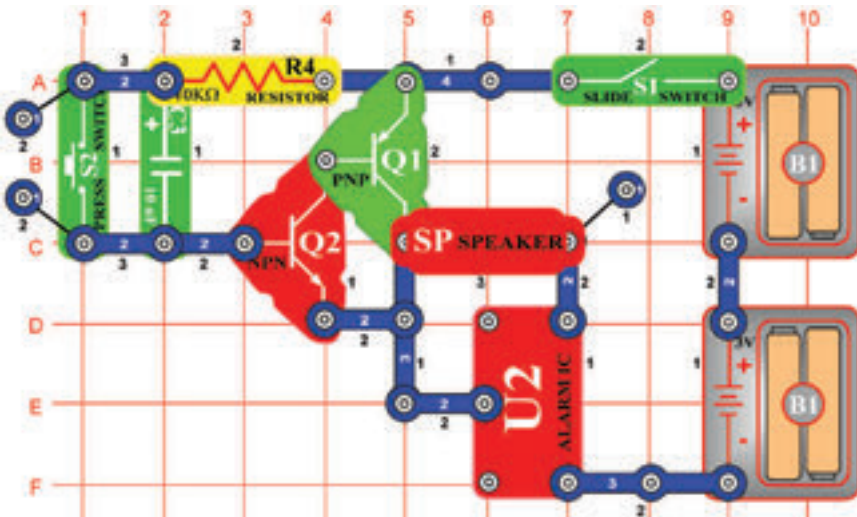

Turn on the slide switch (S1), then press and release the press switch (S2). You hear a siren that slowly fades away and eventually goes off. You can modify this circuit to make machine gun or ambulance sound instead like in the other projects. You can also replace the 10µF capacitor (C3) with the 100µF (C4) or 0.1µF (C2) to greatly slow down or speed up the fading.



Project #298 Fading Doorbell

OBJECTIVE: To build a doorbell that slowly fades away.

Replace the alarm IC (U2) with the music IC (U1). The circuit has a doorbell sound that plays and stops.



Project #299

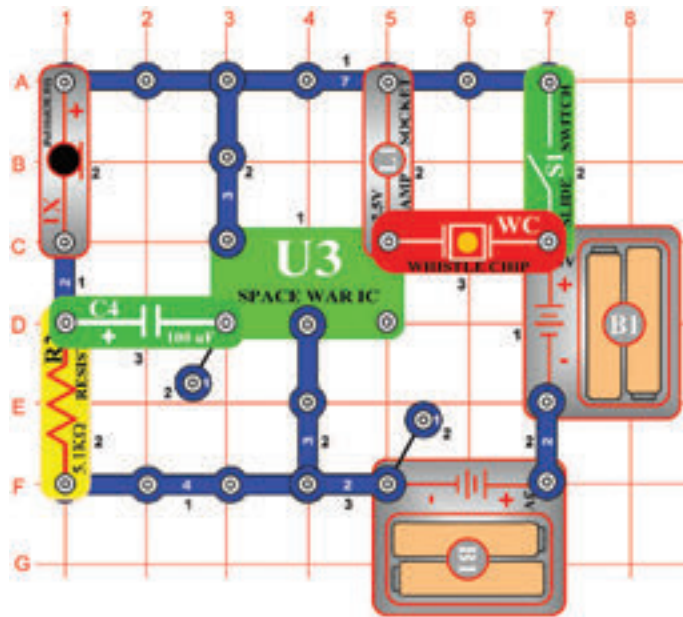

Blowing Space War Sounds

OBJECTIVE: To change space war sounds by blowing.

Turn on the slide switch (S1) and you will hear explosion sounds and the lamp is on or flashing. Blow into the microphone (X1) and you can change the sound pattern.



Project #300 Adjustable Time Delay Lamp

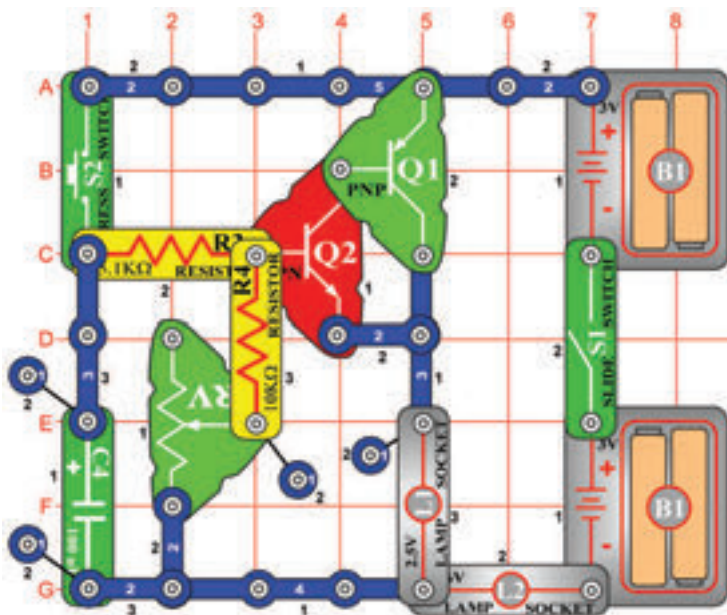

OBJECTIVE: To build a lamp that stays on for a while.

Turn on the slide switch (S1) and press the press switch (S2). The lamps stay on for a while after you release the press switch. You can change the delay time with the adjustable resistor (RV).



Project #301 Adjustable Time Delay Fan

OBJECTIVE: To build a fan that stays on for a while.

Replace the lamp (L1) with the motor (M1), be sure to put on the fan. Turn on the slide switch (S1) and press the press switch (S2). The fan stays on for a while after you release the press switch. You can change the delay time with the adjustable resistor (RV).

WARNING: Moving parts. Do not touch the fan or motor during operation.

Project #302

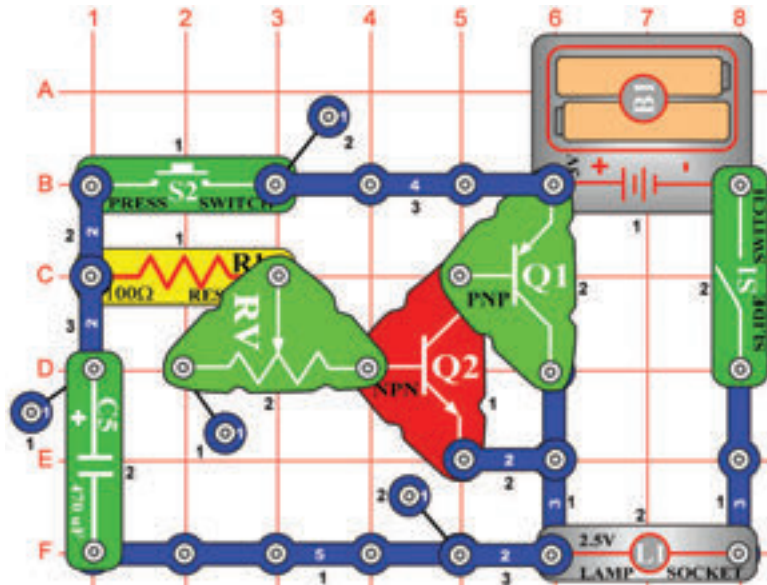

Adjustable Time Delay Lamp (II)

OBJECTIVE: To build a lamp that stays on for a while.

Be sure to use the 2.5V lamp (L1) for this circuit. Turn on the switch and press the press switch (S2). The lamp stays on for a few seconds after you release the press switch. You can change the delay time with the adjustable resistor (RV).

Project #303

Adjustable Time Delay Fan (II)

OBJECTIVE: To build a fan that stays on for a while.

Replace the lamp (L1) with the motor (M1), be sure to put on the fan. Turn on the switch and press the press switch (S2). The fan stays on for a while after you release the press switch. You can change the delay time with the adjustable resistor (RV).

WARNING: Moving parts. Do not touch the fan or motor during operation.

Project #304

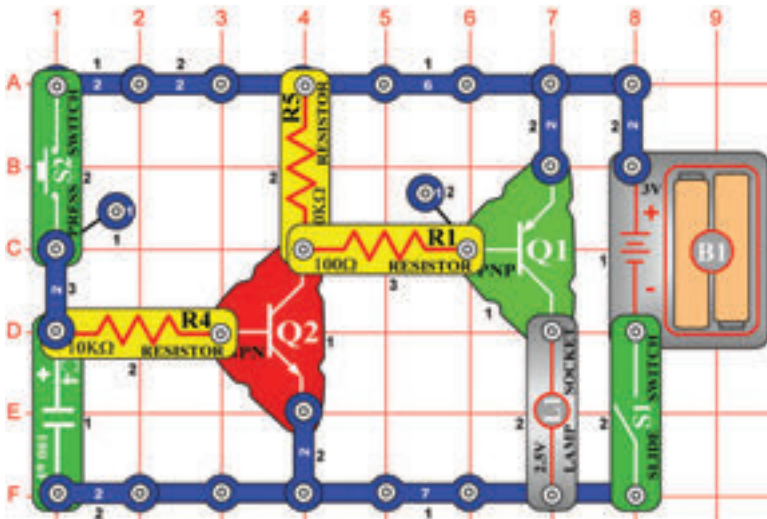

Watch Light

OBJECTIVE: To build a lamp that stays on for a while.

Turn on the switch and press the press switch (S2). The lamp stays on for a few seconds after you release the press switch.

A miniature version of a circuit like this might be in your wristwatch - when you press a light button on the watch to read the time in the dark, a light comes on but automatically turns off after a few seconds to avoid draining the battery.

Project #305

Delayed Bedside Fan

OBJECTIVE: To build a fan that stays on for a while.

Replace the lamp (L1) with the motor (M1, positive (+) side up), be sure to put on the fan. Turn on the switch and press the press switch (S2). The fan stays on for a while after you release the press switch. This could have a longer delay and be near your bed, to turn off after you fall asleep.

WARNING: Moving parts. Do not touch the fan or motor during operation.

The word "BOFFIN" is written in white, bold, uppercase letters inside a blue rounded rectangle with a white border. The background of the entire image is a light gray circuit board pattern.

BOFFIN



All kits and manuals are available at

www.boffin.cz/en



WWW.TOY.CZ

ConQuest entertainment a.s.

Kolbenova 961, 198 00 Praha 9

www.boffin.cz

info@boffin.cz